

can-am®



SIDE-BY-SIDE PRODUCT SPEC BOOK

**VEHICLE SPECIFICATIONS, ACCESSORIES,
PARTS & MAINTENANCE AND APPAREL**

2026

TABLE OF CONTENTS

CAN-AM TRAXTER	5
CAN-AM MAVERICK R	71
CAN-AM MAVERICK	103
MAVERICK TRAIL & MAVERICK SPORT	150
PARTS AND MAINTENANCE	193
CAN-AM APPAREL	217

Pricing is subject to change due to various taxes, tariffs, or duties which may be applicable on certain products. BRP reserves the right to change the prices without incurring any obligations.

CANAMOFFROAD.COM

© 2025 Bombardier Recreational Products Inc. (BRP). All rights reserved. ®, ™ and the BRP logo are trademarks of BRP or its affiliates. †All other trademarks are the property of their respective owners. BRP reserves the right to discontinue or change specifications, prices, designs, features, models or equipment without incurring obligation. Some models shown may include optional equipment. Product performance may vary depending on external factors. BRP recommends that all SxS drivers take a training course. See your dealer. SxS can be hazardous to operate. Never exceed the SxS's passenger capacity. All SxS models are meant to be used by drivers aged 16 and older. Read the operator's guide. Follow all instructional and safety material and observe applicable laws and regulations. SxS are for off-road use only; never ride on paved surfaces or public roads. For your safety, the operator and passenger(s) must wear a helmet, eye protection and applicable protective clothing. Always remember that riding and alcohol/drugs don't mix. Never engage in stunt driving. Avoid excessive speed and be particularly careful on difficult terrain. Always ride responsibly and safely. See your authorised BRP dealer for details and visit <https://can-am.brp.com/>.



IF WE SELL IT, WE STAND BY IT.

BRP Limited Warranty* for new Parts, Accessories and Riding Gear

2-year limited warranty**

- Genuine BRP Parts and Accessories installed by you or your authorized BRP dealer
- Aftermarket Products sold through BRP
- Riding Gear

4-year limited warranty**

- Helmets

**GET ALL THE DETAILS FROM
YOUR CAN-AM OFF-ROAD DEALER**

* Purchased at an authorized BRP dealership/distributor or on a BRP-authorized online store. Other exclusions may apply; see complete limited warranty or contact your Can-Am Off-Road authorized dealer. This limited warranty does not apply to factory-installed accessories and Evinrude parts and accessories.

** Unless otherwise stipulated or required by law.



CUSTOMISING MADE EASY

- 1 SELECT THE MODEL.**
- 2 SELECT THE PACKAGE.**
- 3 CUSTOMISE COLOR, ENGINE, AND ACCESSORIES (OR ACCESSORY BUNDLES) FOR YOUR VEHICLE.**
- 4 CLICK “SAVE” OR “SEND TO DEALER.”**

BUILD YOURS NOW

If you can dream it, you can build it. And ride it. Creating a Can-Am vehicle tailor-made for our riders' needs has never been easier. Scan the QR code and follow the step-by-step.



CAN-AM TRAXTER



CAN-AM TRAXTER

COMPARATIVE CHART 8

ACCESSORIES 12

Roofs	14
Cabs	15
Windshields & Mirrors	16
Rear Wind Protection	20
Doors	21
Seat Accessories	24
Aluminum Skid Plates	25
Bumpers & Guards	26
LinQ: Easy On, Easy Off Cargo	29
Cargo & Storage	36
Racks & Holders	40
ACM & SMART Accessories	44
Lights	46
Audio & Communication Systems	52
Electronic Accessories	54
Winches & Hitches	58
Performance	60
Apache Track Systems	62
ProMount Plows	65
Covers & Add-Ons	70

G2: 2026 Traxter HD11
G1: 2026 Traxter HD7, HD9, HD10
& Prior Traxter





can-am

TRAXTER
XLI

can-am



TRAXTER HD7 T



TRAXTER XU HD7 T



TRAXTER HD9 T

COLOR OPTIONS		COMPASS GREEN	COMPASS GREEN	COMPASS GREEN
ENGINES	Type	52 hp / 42 lb-ft, Rotax® ACE (Advanced Combustion Efficiency) 650 cc single cylinder, liquid cooled, catalytic converter	52 hp / 42 lb-ft, Rotax® ACE (Advanced Combustion Efficiency) 650 cc single cylinder, liquid cooled, catalytic converter	65 hp / 59 lb-ft, Rotax® 976 cc, V-twin, liquid cooled, catalytic converter
	Fuel Delivery System	Intelligent Throttle Control (iTC™) with Electronic Fuel Injection (EFI)	Intelligent Throttle Control (iTC™) with Electronic Fuel Injection (EFI)	Intelligent Throttle Control (iTC™) with Electronic Fuel Injection (EFI)
	Transmission	pDrive primary CVT with engine braking and Electronic Drive Belt Protection L / H / N / R / P	pDrive primary CVT with engine braking and Electronic Drive Belt Protection L / H / N / R / P	PRO-TORQ CVT with Quick Response System (QRS), high airflow ventilation and Electronic Drive Belt Protection Extra-L / H / N / R / P
	Drive Train	Selectable Turf Mode / 2WD / 4WD with Visco-Lok† auto-locking front differential	Selectable Turf Mode / 2WD / 4WD with Visco-Lok† auto-locking front differential	Selectable Turf Mode / 2WD / 4WD with Visco-Lok† auto-locking front differential
	Driving Assistance	Electronic Hill Descent Control ECO™ / ECO™ Off / Work modes Speed Limiter	Electronic Hill Descent Control ECO™ / ECO™ Off / Work modes Speed Limiter	Electronic Hill Descent Control ECO™ / ECO™ Off / Work modes Speed Limiter
	Power Steering		Dynamic Power Steering (DPS™)	
SUSPENSIONS	Front Suspension	Double A-arm / 10 in. (25.4 cm) suspension travel	Double A-arm / 10 in. (25.4 cm) suspension travel	Double A-arm / 10 in. (25.4 cm) suspension travel
	Front Shocks	Twin tube gas charged shocks	Twin tube gas charged shocks	Twin tube gas charged shocks
	Rear Suspension	TTA with external sway bar / 10 in. (25.4 cm) suspension travel	TTA with external sway bar / 10 in. (25.4 cm) suspension travel	TTA with external sway bar / 10 in. (25.4 cm) suspension travel
	Rear Shocks	Twin tube gas charged shocks	Twin tube gas charged shocks	Twin tube gas charged shocks
TIRES / WHEELS	Front / Rear Tires	Maxxis Coronado 2.0† 27 x 9/11 x 14 in.	Maxxis Coronado 2.0† 27 x 9/11 x 14 in.	Maxxis Coronado 2.0† 27 x 9/11 x 14 in.
	Wheels	14 in. steel	14 in. cast-aluminum	14 in. steel
BRAKES	Front	Dual 220 mm disc brakes with hydraulic twin-piston calipers	Dual 220 mm disc brakes with hydraulic twin-piston calipers	Dual 220 mm disc brakes with hydraulic twin-piston calipers
	Rear	Dual 220 mm disc brakes with hydraulic single-piston calipers	Dual 220 mm disc brakes with hydraulic single-piston calipers	Dual 220 mm disc brakes with hydraulic single-piston calipers
	Other	Brake holding mechanism	Brake holding mechanism	Brake holding mechanism
DIMENSIONS / CAPACITIES	Cage	Profiled cage. ROPS approved	Profiled cage. ROPS approved	Profiled cage. ROPS approved
	Estimated Dry Weight*	1,456 lb (660 kg)	1,516 lb (687.8 kg)	1,479 lb (671 kg)
	L x W x H	121 x 62 x 76 in. (307.1 x 157.5 x 193 cm)	125.7 x 62 x 78 in. (319.4 x 157.5 x 198.1 cm)	121 x 62 x 76 in. (307.1 x 157.5 x 193 cm)
	Wheelbase	83 in. (211.5 cm)	83 in. (211.5 cm)	83 in. (211.5 cm)
	Ground Clearance	11 in. (28 cm)	11 in. (28 cm)	11 in. (28 cm)
	Cargo Box Dimensions	38 x 54.5 x 12 in. (96.5 x 138.4 x 30.5 cm)	38 x 54.5 x 12 in. (96.5 x 138.4 x 30.5 cm)	38 x 54.5 x 12 in. (96.5 x 138.4 x 30.5 cm)
	Cargo Box Capacity	1,000 lb (454 kg)	1,000 lb (454 kg)	1,000 lb (454 kg)
	Power tilt bed			N/A
	Tailgate Load Capacity	250 lb (113.4 kg)	250 lb (113.4 kg)	250 lb (113.4 kg)
	Storage Capacity	Total: 3.1 gal (11.7 L)	Total: 6.5 gal (24.5 L)	Total: 3.1 gal (11.7 L)
	Towing Capacity	2,500 lb (1,134 kg)	2,500 lb (1,134 kg)	2,500 lb (1,134 kg)
	Payload Capacity	1,500 lb (680 kg)	1,500 lb (680 kg)	1,500 lb (680 kg)
Fuel Capacity	10.6 gal (40 L)	10.6 gal (40 L)	10.6 gal (40 L)	
Person Capacity	3	3	3	
FEATURES	Gauge	7.6 in. wide digital display with keypad	7.6 in. wide digital display with keypad	7.6 in. wide digital display with keypad
	Battery	12-V (18 amp/h)	12-V (30 amp/h)	12-V (18 amp/h)
	Magneto	650-W	650-W	650-W
	Instrumentation	DC outlet (10-A)	DC outlet (10-A)	DC outlet (10-A)
	Anti-theft System		RF Digitally Encoded Security System (D.E.S.S.™) with Start/Stop button	
	Lighting	Front lighting output 110-W LED headlights and premium tail lights	Front lighting output 110-W LED headlights and premium tail lights	Front lighting output 110-W LED headlights and premium tail lights
	Winch		4,500 lb (2,041 kg) winch with synthetic cable	
	Seat	60/40 VERSA-PRO bench seat with passenger seats flipping up, Underside hooks, adjustable driver seat	60/40 VERSA-PRO bench seat with passenger seats flipping up, underside hooks, reinforced seat skin, adjustable driver seat	60/40 VERSA-PRO bench seat with passenger seats flipping up, Underside hooks, adjustable driver seat
	Steering Wheel	Tilt steering adjustment	Tilt steering adjustment	Tilt steering adjustment
	Protection	Integrated front steel bumper HMWPE central skid plate	Integrated front steel bumper Full heavy-duty HMW plastic skid plate	Integrated front steel bumper HMWPE central skid plate
	Hitch Type	2 in. hitch receiver with rear hitch, tow ball and trailer connexion	2 in. hitch receiver with rear hitch, tow ball and trailer connexion	2 in. hitch receiver with rear hitch, tow ball and trailer connexion



TRAXTER XU HD9 T ABS

TRAXTER PRO XU HD10 T ABS

COLOR OPTIONS		COMPASS GREEN DUSTY NAVY SATIN	COMPASS GREEN STEALTH BLACK
ENGINES	Type	65 hp / 59 lb-ft, Rotax® 976 cc, V-twin, liquid cooled, catalytic converter	82 hp / 69 lb-ft, Rotax® 976 cc, V-twin, liquid cooled, catalytic converter
	Fuel Delivery System	Intelligent Throttle Control (ITC™) with Electronic Fuel Injection (EFI)	Intelligent Throttle Control (ITC™) with Electronic Fuel Injection (EFI)
	Transmission	PRO-TORQ CVT with Quick Response System (QRS), high airflow ventilation and Electronic Drive Belt Protection Extra-L / H / N / R / P	PRO-TORQ CVT with Quick Response System (QRS), high airflow ventilation and Electronic Drive Belt Protection Extra-L / H / N / R / P
	Drive Train	Selectable Turf Mode / 2WD / 4WD with open front differential with ABS system	Selectable Turf Mode / 2WD / 4WD with open front differential with ABS system
	Driving Assistance	Electronic Hill Descent Control ECO™ / ECO™ Off / Work modes Speed Limiter	Electronic Hill Descent Control ECO™ / ECO™ Off / Work modes Speed Limiter
	Power Steering	Dynamic Power Steering (DPS™)	Dynamic Power Steering (DPS™)
SUSPENSIONS	Front Suspension	Arched double A-arm / 11 in. (27.9 cm) suspension travel	Arched double A-arm / 11 in. (27.9 cm) suspension travel
	Front Shocks	Twin tube gas charged shocks	Twin tube gas charged shocks
	Rear Suspension	Arched TTA with external sway bar / 11 in. (27.9 cm) suspension travel	Arched TTA with external sway bar / 11 in. (27.9 cm) suspension travel
	Rear Shocks	Twin tube gas charged shocks	Twin tube gas charged shocks
TIRES / WHEELS	Front / Rear Tires	Maxxis Coronado 2.0† 27 x 9/11 x 14 in.	Maxxis Coronado 2.0† 27 x 9/11 x 14 in.
	Wheels	14 in. cast-aluminum	14 in. cast-aluminum
BRAKES	Front	Dual 220 mm disc brakes with hydraulic twin-piston calipers	Dual 220 mm disc brakes with hydraulic twin-piston calipers
	Rear	Dual 220 mm disc brakes with hydraulic single-piston calipers	Dual 220 mm disc brakes with hydraulic twin-piston calipers
	Other	Brake holding mechanism	Brake holding mechanism
DIMENSIONS / CAPACITIES	Cage	Profiled cage. ROPS approved	Profiled cage. ROPS approved
	Estimated Dry Weight*	1,572 lb (713 kg)	1,964 lb (891 kg)
	L x W x H	125.7 x 64 x 80 in. (319.4 x 162.5 x 203.2cm)	154.1 x 64 x 78 in. (391.5 x 162.5 x 198.1 cm)
	Wheelbase	83 in. (211.5 cm)	115.5 in. (294 cm)
	Ground Clearance	13 in. (33 cm)	12.5 in. (32 cm)
	Cargo Box Dimensions	38 x 54.5 x 12 in. (96.5 x 138.4 x 30.5 cm)	72 x 54.5 x 10 in. (180.3 x 138.4 x 25.4 cm)
	Cargo Box Capacity	1,000 lb (454 kg)	1,200 lb (544 kg)
	Power tilt bed	N/A	N/A
	Tailgate Load Capacity	250 lb (113.4 kg)	250 lb (113.4 kg)
	Storage Capacity	Total: 6.5 gal (24.5 L)	Total: 94 gal (356 L)
	Towing Capacity	2,500 lb (1,134 kg)	2,500 lb (1,134 kg)
	Payload Capacity	1,500 lb (680 kg)	1,700 lb (771 kg)
	Fuel Capacity	10.6 gal (40 L)	10.6 gal (40 L)
	Person Capacity	3	3
FEATURES	Gauge	7.6 in. wide digital display with keypad	7.6 in. wide digital display with keypad
	Battery	12-V (30 amp/h)	12-V (30 amp/h)
	Magneto	650-W	650-W
	Instrumentation	DC outlet (10-A)	DC outlet (10-A)
	Anti-theft System	RF Digitally Encoded Security System (D.E.S.S.™) with Start/Stop button	RF Digitally Encoded Security System (D.E.S.S.™) with Start/Stop button
	Lighting	Front lighting output 110-W LED headlights and premium tail lights	Front lighting output 110-W LED headlights and premium tail lights
	Winch	4,500 lb (2,041 kg) winch with synthetic cable	4,500 lb (2,041 kg) winch with synthetic cable
	Seat	60/40 VERSA-PRO bench seat with passenger seats flipping up, underside hooks, reinforced seat skin, adjustable driver seat	60/40 VERSA-PRO bench seat with passenger seats flipping up, underside hooks, reinforced seat skin adjustable driver seat
	Steering Wheel	Tilt steering adjustment	Tilt steering adjustment
	Protection	Integrated front steel bumper Full heavy-duty HMW plastic skid plate Front fender extension	Integrated front steel bumper Full heavy-duty HMW plastic skid plate Front fender extension
	Hitch Type	2 in. hitch receiver with rear hitch, tow ball and trailer connexion	2 in. hitch receiver with rear hitch, tow ball and trailer connexion



TRAXTER 6X6 DPS HD10



TRAXTER XU HD11 T ABS



TRAXTER MAX XU HD11 T ABS

COLOR OPTIONS		COMPASS GREEN	STEALTH BLACK	STEALTH BLACK
ENGINES	Type	82 hp / 69 lb-ft, Rotax® 976 cc, V-twin, liquid cooled	95 hp / 70 lb-ft Rotax® ACE (Advanced Combustion Efficiency) 999 cc triple cylinder, liquid cooled	95 hp / 70 lb-ft Rotax® ACE (Advanced Combustion Efficiency) 999 cc triple cylinder, liquid cooled
	Fuel Delivery System	Intelligent Throttle Control (iTC™) with Electronic Fuel Injection (EFI)	Intelligent Throttle Control (iTC™) with Electronic Fuel Injection (EFI)	Intelligent Throttle Control (iTC™) with Electronic Fuel Injection (EFI)
	Transmission	PRO-TORQ CVT with Quick Response System (QRS), high airflow ventilation and Electronic Drive Belt Protection Extra-L / H / N / R / P	pDrive primary and Quick Response System X (QRS-X) CVT with high airflow and Electronic Drive Belt Protection L / H / N / R / P	pDrive primary and Quick Response System X (QRS-X) CVT with high airflow and Electronic Drive Belt Protection L / H / N / R / P
	Drive Train	Selectable 4WD / 6WD auto-Locking front differential	Selectable Turf Mode / 2WD / 4WD with Open-4Lok front differential with ABS system	Selectable Turf Mode / 2WD / 4WD with Open-4Lok front differential with ABS system
	Driving Assistance	CVT Engine Braking ECO™ / ECO™ Off / Work modes Speed Limiter	CVT Engine Braking Sport / Normal / Work modes Speed Limiter	CVT Engine Braking Sport / Normal / Work modes Speed Limiter
	Power Steering	Dynamic Power Steering (DPS™)	Dynamic Power Steering (DPS)	Dynamic Power Steering (DPS)
SUSPENSIONS	Front Suspension	Arched double A-arm / 11 in. (27.9 cm) suspension travel	Arched Double A-Arm with sway bar / 12 in. (30.5 cm) suspension travel	Arched Double A-Arm with sway bar / 12 in. (30.5 cm) suspension travel
	Front Shocks	Twin tube gas charged shocks	Twin tube gas charged shocks	Twin tube gas charged shocks
	Rear Suspension	Arched TTA with external sway bar / 11 in. (27.9 cm) suspension travel	Arched Double A-Arm / 12 in. (30.5 cm) suspension travel	Arched Double A-Arm / 12 in. (30.5 cm) suspension travel
	Rear Shocks	Twin tube gas charged shocks	Twin tube gas charged shocks	Twin tube gas charged shocks
TIRES / WHEELS	Front / Rear Tires	XPS Trail King 27 x 9/11 x 14 in.	XPS Trail King 2 27 x 9/11 x 14 in.	XPS Trail King 2 27 x 9/11 x 14 in.
	Wheels	14 in. cast-aluminum	14 in. cast-aluminum	14 in. cast-aluminum
BRAKES	Front	Dual 220 mm disc brakes with hydraulic twin-piston calipers	Dual 262 mm disc brakes with hydraulic twin-piston calipers (32 mm)	Dual 262 mm disc brakes with hydraulic twin-piston calipers (32 mm)
	Rear	Dual 220 mm disc brakes with hydraulic twin-piston calipers	Dual 236 mm disc brakes with hydraulic single piston caliper (32 mm)	Dual 236 mm disc brakes with hydraulic single piston caliper (32 mm)
	Other		Brake holding mechanism	Brake holding mechanism
DIMENSIONS / CAPACITIES	Cage	Profiled cage, ROPS approved	Profiled cage, ROPS approved	Profiled cage, ROPS approved
	Estimated Dry Weight*	1,953 lb (886 kg)	1,890 lb (857 kg)	2,215 lbs (1005 kg)
	L x W x H	154.1 x 64 x 78 in. (391.5 x 162.5 x 198.1 cm)	122.7 x 65 x 81 in. (312 x 165 x 206 cm)	155.5 x 65 x 81.4 (395 x 165 x 207 cm)
	Wheelbase	115.5 in. (294 cm)	85 in. (216 cm)	117.5 in (298 cm)
	Ground Clearance	13 in. (33 cm)	14 in. (35.6 cm)	14 in. (35.6 cm)
	Cargo Box Dimensions	72 x 54.5 x 10 in. (180,3 x 138.4 x 25.4 cm)	38 x 54.5 x 12 in. (96.5 x 138.4 x 30.5 cm)	38 x 54.5 x 12 in. (96.5 x 138.4 x 30.5 cm)
	Cargo Box Capacity	1,000 lb (454 kg)	1,000 lb (454 kg)	1,000 lb (454 kg)
	Power tilt bed			
	Tailgate Load Capacity	250 lb (113.4 kg)	250 lb (113.4 kg)	250 lb (113.4 kg)
	Storage Capacity	Total: 10.4 gal (39.5 L)	Weather resistant above gage glove box Weather resistant passenger glove box with USB-C, USB-A & DC outlet Cubby storage and lower dash storage 3.7 gal (14 L) under seat removable bin	Weather resistant above gage glove box Weather resistant passenger glove box with USB-C, USB-A & DC outlet Cubby storage and lower dash storage 3.7 gal (14 L) under seat removable bin
	Towing Capacity	3,000 lb (1360.8 kg)	2,450 lb (1,111 kg)	2,450 lb (1,111 kg)
Payload Capacity	1,700 lb (771 kg)	1,500 lb (680 kg)	1,500 lb (680 kg)	
Fuel Capacity	10.6 gal (40 L)	11.9 gal (45 L)	11.9 gal (45 L)	
Person Capacity	3	3	6	
FEATURES	Gauge	4.5 in. wide digital display	4.5 in. wide digital display with keypad	4.5 in. wide digital display with keypad
	Battery	12-V (30 amp/h)	400 CCA (30 amp/h)	400 CCA (30 amp/h)
	Magneto	650-W	650-W	650-W
	Instrumentation	DC outlet (10-A)	USB outlet Lighter DC Outlet	USB outlet Lighter DC Outlet
	Anti-theft System		RF Digitally Encoded Security System (D.E.S.S.™) with Start/Stop button	RF Digitally Encoded Security System (D.E.S.S.™) with Start/Stop button
	Lighting	Front lighting output 140-W LED headlights and tail lights	LED headlights LED tail lights with flashers LED signature	LED headlights LED tail lights with flashers LED signature
	Winch		4,500 lb (2,041 kg) winch with synthetic cable	4,500 lb (2,041 kg) winch with synthetic cable
	Seat	VERSA-PRO bench seat with passenger seats flipping up Underside hooks	Adjustable driver seat 60/40 Reinforced	Adjustable driver seat 60/40 Reinforced
	Steering Wheel	Tilt steering adjustment	Premium steering wheel with keypad space Tilt steering adjustment	Premium steering wheel with keypad space Tilt steering adjustment
	Protection	Integrated front steel bumper HMWPE central skid plate	Full heavy-duty HMW plastic skid plate Door safety net Lower front mudflap	Full heavy-duty HMW plastic skid plate Door safety net Lower front mudflap
	Hitch Type	2 in hitch receiver	2 in. hitch receiver with rear hitch, tow ball and trailer connexion	2 in. hitch receiver with rear hitch, tow ball and trailer connexion

TRAXTER HERO UNITS PACKAGES

STEP 1 ESSENTIALS	PACKAGE	DESCRIPTION	TRAXTER G1	TRAXTER G2	
	Starter Essentials	USB Power Outlet Kit (G1)		219400510	
		Center Underseat Storage Bin		715003446	715009199
		Removable Storage Bin		715004344	
		Fender Flares		715006821 / 715006001 / 715005409	715009177
		Emergency Kit		715006102	715006102
		Trailer Cover		715004453 / 715004454	
+					

STEP 2 USAGES	PACKAGE	DESCRIPTION	TRAXTER G1	TRAXTER G2	
	Adventure	Deluxe Sport Roof		715002511 / 715003039	715010883 / 715010884
		Flip Glass Windshield With Wiper & Washer Kit		715002441	715009890
		Wiper & Power Windows Cable		710004462	715009756
		Roof Power Cable (Needed for the Wiper and Washer Kit)		715003094	715010489
		Rear Polycarbonate Window		715009325	715009325
		Front Bumper		715006143	715009164
		Rear Bumper		715008109	715009158
		Rock Sliders		715002569 / 715003040	715009421 / 715010031
		15" (38 cm) Double Stacked LED Light Bar (90 W) or SMART 10" (25 cm) LED Light Bar		715010066	715008745
		Power Cable (Needed for the LED Light Bar)		715003417	715009886
		Adventure Roof Rack or Cargo Rack		715003870 / 715004391	715009148 / 715009170
		LinQ Tire Holder		715003448	715003448

* To complete the package we recommend the installation of an Aluminum Skid Plate Protection Kit.
 ** 15" (38 cm) Double Stacked LED Light Bar (90 W) or SMART 10" (25 cm) LED Light Bar to be installed in the Adventure Roof Rack or Cargo Rack.

OR

PACKAGE	DESCRIPTION	TRAXTER G1	TRAXTER G2
Utility	Deluxe Sport Roof	715002511 / 715003039	715010883 / 715010884
	Flip Glass Windshield With Wiper & Washer Kit	715002441	715009890
	Wiper & Power Windows Cable	710004462	715009756
	Roof Power Cable (Needed for the Wiper and Washer Kit)	715003094	715010489
	Rear Glass Window	715009325	715009325
	Front Bumper	715005754	715009164
	Rear Bumper	715008109	715009158
	Deluxe Headache Rack	715002423	715009171
	Bed Tool Box	715009165	715009165
	LinQ Tailgate Extension	715002464	715009179
	LinQ Tool Holder	715007358	715007358
	LinQ Adapter (Needed for the LinQ Tool Holder)	715003058	
	10" (25 cm) Double Stacked LED Light Bar (60 W) or SMART 10" (25 cm) LED Light Bar	715010065	715008745
	Light Power Cable (Needed for the LED Light Bar)	715006034	715009886
	Rear LED Light	715008236	715008236
	Lights Wiring Harness (Needed for the Rear LED Light)	715009886	715009886
LinQ Front Rack	715006064		

* 10" (25 cm) Double Stacked LED Light Bar (60 W) or SMART 10" (25 cm) LED Light Bar to be installed in the Front Bumper.
 ** In Base and DPS units will require the installation of a Front Winch.

TRAXTER HERO UNITS PACKAGES

STEP 2 USAGE

OR

PACKAGE	DESCRIPTION	TRAXTER G1	TRAXTER G2
Farming	Clear Rigid Cab	715010068 / 715010069	715010068 / 715010069
	Windshield Wiper & Washer Kit	715001638	715009441
	Wiper & Power Windows Cable	710004462	715009756
	Roof Power Cable (Needed for the Wiper and Washer Kit)	715003094	715010489
	Front Roof Liner	715008226	715009196
	Rear Roof Liner	715006334 / 715006391	715006334 / 715006391
	Front Bumper	715005754	715009164
	Rear Bumper	715008109	715009158
	Deluxe Headache Rack	715002423	715009171
	Bed Wall Extender	715002421 / 715005411	715009590
	LinQ Tool Holder	715007358	715007358
	LinQ Adapter (Needed for the LinQ Tool Holder)	715003058	
	Rear LED Light	715008236	715008236
	Lights Wiring Harness (Needed for the Rear LED Light)	715009886	715009886
	Can-Am ProMount Mounting Plate	715007745	
	Can-Am ProMount Push Frame with Quick-Attach System	715008116	715008888
	Power Tilt Bed	715007096 / 715007204	715009452
	10" (25 cm) Double Stacked LED Light Bar (60 W) or SMART 10" (25 cm) LED Light Bar	715010065	715008745
Light Power Cable (Needed for the LED Light Bar)	715006034	715009886	

* 10" (25 cm) Double Stacked LED Light Bar (60 W) or SMART 10" (25 cm) LED Light Bar to be installed in the Front Bumper.

** In Base and DPS units will require the installation of a Front Winch.

OR

PACKAGE	DESCRIPTION	TRAXTER G1	TRAXTER G2
Hunting	Deluxe Cab Enclosure	715010938 / 715010939	715010063 / 715010064
	Front Bumper	715005754	715009164
	Rear Bumper	715008109	715009158
	Rock Sliders	715002569 / 715003040	715009421 / 715010031
	Deluxe Headache Rack	715002423	715009171
	Adventure Roof Rack or Cargo Rack	715003870 / 715004391	715009148 / 715009170
	LinQ Gun Case	715009240	715009240
	LinQ Gun Case Mounting Kit	715006443	715006443
	39" (99 cm) Double Stacked LED Light Bar (270 W) or SMART 40" (102 cm) LED Light Bar	715004007	715008747
	Power Cable (Needed for the LED Light Bar)	715005822	715009930

* To complete the package we recommend the installation of an Aluminum Skid Plate Protection Kit.

** 39" (99 cm) Double Stacked LED Light Bar (270 W) or SMART 40" (102 cm) LED Light Bar to be installed in the Adventure Roof Rack or Cargo Rack.

*** In Base and DPS units will require the installation of a Front Winch.

**** Front and Rear Door Trims need to be order separately matching the color of the unit.

TRAXTER HERO UNITS PACKAGES

STEP 2 USAGE

OR

PACKAGE	DESCRIPTION	TRAXTER G1	TRAXTER G2
Snow	Deluxe Cab Enclosure	715010938 / 715010939	715010063 / 715010064
	Defrost, Heat & Ventilation System	715008093*	
	Heated Seats	715006112	715006112
	Harness for Front Heated Seats	710005757** / 710006036	710005757
	Harness for Rear Heated Seats	715006004	715006004
	Apache XC LT Track Kit	715007719	715007719
	Apache XC LT Track Kit Mounting Kit	715006891***	715009252
	Front Bumper	715006143	715009164
	Rear Bumper	715008109	715009158
	Rock Sliders	715002569 / 715003040	715009421 / 715010031
	Can-Am ProMount Steel 72" (183 cm) Blade Plow Kit	715008172	715009135
	Deluxe Headache Rack	715002423	715009171
	LinQ Tool Holder	715007358	715007358
	LinQ Adapter (Needed for the LinQ Tool Holder)	715003058	
	Rear LED Light	715008236	715008236
	Lights Wiring Harness (Needed for the Rear LED Light)	715009886	715009886
	3.5" (9 cm) LED Flood Lights (2 x 14 W)	715010093	715010093
	Light Power Cable (Needed for the LED Lights)	715006034	715006034

* Except XU models already coming with Defrost, Heat & Ventilation System.

** For XU models change to SKU 710006036.

*** For Arched double A-arm Front Suspension models change to SKU 715008612.

**** To complete the package we recommend the installation of an Aluminum Skid Plate Protection Kit.

***** 3.5" (9 cm) LED Flood Lights (2 x 14 W) to be installed in the Front Bumper.

***** In Base and DPS units will require the installation of a Front Winch.

***** Front and Rear Door Trims need to be order separately matching the color of the unit.

OR

PACKAGE	DESCRIPTION	TRAXTER G1	TRAXTER G2
Winter	Deluxe Cab Enclosure	715010938 / 715010939	715010063 / 715010064
	Defrost, Heat & Ventilation System	715008093*	
	Heated Seats	715006112	715006112
	Harness for Front Heated Seats	710005757** / 710006036	710005757
	Harness for Rear Heated Seats	715006004	715006004

* Except XU models already coming with Defrost, Heat & Ventilation System.

** For XU models change to SKU 710006036.

ROOFS

Sport Roof	Traxter G1, Traxter G2	715002430
	Traxter G1 MAX, Traxter G2 MAX	715003038



- Robust injection-molded polypropylene construction.
- Provides added protection for rider and passenger from the elements.

Deluxe Sport Roof	Traxter G1	715002511
	Traxter G1 MAX	715003039
	Traxter G2	715010883 NEW
	Traxter G2 MAX	715010884 NEW



- Complete roof kit provides extra driver and passenger protection and also diminishes noise within the cab.
- Perfect fit and finish thanks to the seal kit and the liners included.
- Rear Roof Liner is not compatible with Soft Rear Panel.

Includes

- Sport Roof
- Sport Roof Seal Kit
- Front Roof Liner
- Rear Roof Liner

Sport Roof Seal Kit <i>(Not illustrated)</i>	Traxter G1, Traxter G2	715003126
	Traxter G1 MAX, Traxter G2 MAX	715003583

- Necessary when installing individual cab components with Sport Roof or when installing the Front and Rear Roof Liners.

Bimini Roof with Sun Visor	Traxter G1 MAX, Traxter G2 MAX	■ 715003030 • Black
-----------------------------------	--------------------------------	----------------------------



- Heavy-duty canvas made of UV-resistant polyester.
- Soft top comes with a hard visor that allows for storage of rolled-up soft top and mounting of Light Rack.
- Quick and easy installation.

NEW Front Roof Liner	Traxter G2, Traxter G2 MAX	715009196
-----------------------------	----------------------------	------------------



- Vehicle enhancement.
- Integrates seamlessly with roof-mounted light switch.
- Required for installation of roof-mounted lights.
- Allows a better integration of Windshield Wiper and Washer Kit.
- Seal Kit necessary when installing with Sport Roof.

Front Roof Liner	Traxter G1, Traxter G1 MAX	715008226
-------------------------	----------------------------	------------------



- Vehicle enhancement.
- Integrates seamlessly with roof-mounted light switch.
- Required for installation of roof-mounted lights and audio systems.
- Allows a better integration of Windshield Wiper and Washer Kit.
- Seal Kit necessary when installing with Sport Roof.

Rear Roof Liner	Traxter G1, Traxter G2 [†]	715006334
	Traxter G1 MAX, Traxter G2 MAX [‡] (Not illustrated)	715006391



- Quick and easy vehicle enhancement.
- Allows better integration of other accessories installed on the roof.
- Seal Kit necessary when installing with Sport Roof.
- Not compatible with: 715002920, 715006680, 715003249, 715002852.

[†]Needs to be installed with Sport Roof (715002430).

[‡]Needs to be installed with Sport Roof (715003038).

CABS

HARD CABS

NEW Clear Rigid Cab

Traxter G1, Traxter G2

715010068

Traxter G1 MAX, Traxter G2 MAX

715010069



Includes:

- Front Clear Rigid Doors (715010067).
- Rear Clear Rigid Doors (MAX models only) (715006262).
- Sport Roof (715002430).
- Sport Roof Max (MAX models only) (715003038).
- Glass Windshield (715010876).
- Rear Polycarbonate Window (715009325).
- Mirror adaptors 715009750 required to re-use mirrors coming with the unit.

Installation of some accessories shown may impact vehicle compliance with some regulations. Consult your local dealer for information.

NEW Deluxe Cab Enclosure

Traxter G2 (except X mr models)

715010063

Traxter G2 MAX (except X mr models)

715010064



- Provides driver and passenger with the best protection from the elements and the cold, and features the most complete top-of-the-line accessories our product lineup has to offer.
- Key locking door latches.

Includes:

- Deluxe Sport Roof Kit (715010883 or 715010884).
- Flip Glass Windshield With SMART Intermittent Wiper & Washer Kit (715009890).
- Front and Rear Deluxe Full Doors with Key Locking Door Latches (715010568 & 715010569).
- Rear Glass Window (715007079).
- Wiper and Powered Windows Cable (715009756).
- Wire Cover Kit and Roof Power Cable (715010489).
- Color Panels are required (sold separately).

Installation of some accessories shown may impact vehicle compliance with some regulations. Consult your local dealer for information.

Deluxe Cab Enclosure

Traxter G1 (except X mr models)

715010938

Traxter G1 MAX (except X mr models)

715010939



- Provides driver and passenger with the best protection from the elements and the cold, and features the most complete top-of-the-line accessories our product lineup has to offer.

Includes:

- Deluxe Sport Roof Kit.
- Flip Glass Windshield with Wiper and Washer Kit.
- Front and Rear Deluxe Full Doors with Key Locking Door Latches.
- Rear Glass Window.
- Wiper and Powered Windows Cable.
- Roof Power Cable.
- Color Panels required (sold separately).

Installation of some accessories shown may impact vehicle compliance with some regulations. Consult your local dealer for information.

HYBRID CABS

NEW Hybrid Cab Enclosure

Traxter G2 (except X mr models)

715011103

Traxter G2 MAX (except X mr models)

715011104



- Offers good protection from the elements for driver and passenger.

Includes:

- Sport Roof.
- Full Windshield - Hardcoated.
- Soft Doors.
- Rear Polycarbonate Window.

Installation of some accessories shown may impact vehicle compliance with some regulations. Consult your local dealer for information.

Hybrid Cab Enclosure	Traxter G1 (all model years) (except X mr models)	715008063
	Traxter G1 MAX 2018 & prior, Traxter G1 MAX 2022 & up (models produced after January 18, 2021) (except X mr models)	715008064



- Included:
- Sport Roof
 - Full Hardcoated Windshield
 - Soft Doors
 - Rear Polycarbonate Window

Installation of some accessories shown may impact vehicle compliance with some regulations. Consult your local dealer for information.

NEW Floor Mats	Traxter G2	715008754
	Traxter G2 MAX	715010588



- These durable floor mats are custom-made using 6.4 mm-thick, pre-molded rubber.
- The kit includes all the pieces to cover the entire vehicle floor.
- They're constructed with a non-slip texture that provides an excellent grip to keep your feet firmly in place.
- They help cut down on noise.
- Easily washable.

WINDSHIELDS & MIRRORS

WINDSHIELDS

Powerflip Windshield	Traxter G1, Traxter G1 MAX	715003885
-----------------------------	----------------------------	------------------



- The PowerFlip Windshield is equipped with electric cylinders that allow the rider to adjust the windshield opening at the touch of a button.
- Windshield is made of hardcoated polycarbonate with a rubber seal contour and a tinted top section.
- Allows you to quickly adapt to changing conditions by adjusting the windshield as you go.
- Can be fully opened for optimal visibility and ventilation, fully closed for maximum protection from the elements, and in between, you have an infinite number of opening possibilities depending on protection, visibility and air flow preferences.
- Compatible with Can-Am roofs and windshield wiper and washer kit.

Installation of some accessories shown may impact vehicle compliance with some regulations. Consult your local dealer for information.

Flip Glass Windshield	Traxter G1, Traxter G1 MAX, Traxter G2, Traxter G2 MAX	715009225 NEW
------------------------------	--	-----------------------------



- Its enhanced handle allows for quick, low-effort opening (715009225 only).
- Curved and laminated glass full windshield in metal frame.
- Provides excellent optical clarity.
- Seals firmly against the cage and protects rider and passenger from the elements while allowing for controlled air flow.
- 3-position flip can be set at fully closed, ¼ open, or fully open.
- Gas-shock-assisted operation and pivots on 2 hinges located at the top of the windshield.
- Ideal for muddy conditions.
- Can be used with Windshield Wiper & Washer Kit (715001638 Traxter G1 or 715009441 Traxter G2).

Installation of some accessories shown may impact vehicle compliance with some regulations. Consult your local dealer for information.

NEW Flip Glass Windshield with SMART Intermittent Wiper & Washer Kit	Traxter G2, Traxter G2 MAX	715009890
---	----------------------------	------------------



- Its enhanced handle allows for quick, low-effort opening.
- Curved and laminated glass full windshield in metal frame.
- Provides excellent optical clarity.
- Seals firmly against the cage and protects rider and passenger from the elements while allowing for controlled airflow.
- 3-position flip can be set at fully closed, ¼ open, or fully open.
- Ideal for muddy conditions.
- Gas-shock-assisted operation and pivots on 2 hinges located at the top of the windshield.
- Includes single-speed wiper, washer fluid dispenser and windshields frame mount.
- Intermittent wiper speed feature available when the kit is installed in combination with ACM and automatic speed variation mode that varies with vehicle speed.
- Requires Wiper and Power Cables when ACM is not installed:
 - If equipped with the Sport Roof, Power Cables (715010489 & 715009756) are required.
 - If equipped with the Audio Roof, Power Cable (715010324) is required.

Installation of some accessories shown may impact vehicle compliance with some regulations. Consult your local dealer for information.

Flip Glass Windshield with Wiper & Washer Kit

Traxter G1, Traxter G1 MAX

715002441

- Curved and laminated glass full windshield in metal frame.
- Provides excellent optical clarity.
- Seals firmly against the cage and protects rider and passenger from the elements while allowing for controlled airflow.
- 3-position flip can be set at fully closed, ¼ open, or fully open.

- Ideal for muddy conditions.
- Gas-shock-assisted operation and pivots on 2 hinges located at the top of the windshield.
- Single-speed wiper with washer fluid dispenser.
- Requires Wiper and Power Cables: If equipped with the Sport Roof, Power Cables 710004462 & 715003094 are required. If equipped with the Audio Roof, Power Cables 715008781 & 715003094 are required.

Installation of some accessories shown may impact vehicle compliance with some regulations. Consult your local dealer for information.

NEW Flip Windshield – Hardcoated

Traxter G1, Traxter G1 MAX, Traxter G2, Traxter G2 MAX

715010010

- Its enhanced handle allows for quick, low-effort opening (715010010 only).
- High-impact-resistant Makrolon¹ hardcoated polycarbonate full windshield in metal frame.
- Provides excellent optical clarity and better abrasion resistance.

- Seals firmly against the cage and protects rider and passenger from the elements while allowing for controlled airflow.
- 3-position flip can be set at fully closed, ¼ open, or fully open.
- Gas-shock-assisted operation.
- Ideal for muddy conditions.

Installation of some accessories shown may impact vehicle compliance with some regulations. Consult your local dealer for information.

NEW Glass Windshield

Traxter G1, Traxter G1 MAX, Traxter G2, Traxter G2 MA

715010876

- Curved and laminated glass full windshield in metal frame.
- Seals firmly against the cage and protects rider and passenger from the elements while providing excellent optical clarity.

- Must be used with Windshield Wiper & Washer Kit (715001638 Traxter G1 or 715009441 Traxter G2) to maintain clear visibility during severe riding conditions.

Installation of some accessories shown may impact vehicle compliance with some regulations. Consult your local dealer for information.

Full Windshield – Hardcoated

Traxter G1, Traxter G1 MAX, Traxter G2, Traxter G2 MAX

715002432

- High-impact-resistant Makrolon¹ hardcoated polycarbonate full windshield.
- Provides excellent optical clarity and better abrasion resistance.
- Protects driver and passenger from the elements.
- Quick and easy tool-less installation or removal.

Installation of some accessories shown may impact vehicle compliance with some regulations. Consult your local dealer for information.

Full Windshield

Traxter G1, Traxter G1 MAX

715002431

- High-impact-resistant durable polycarbonate full windshield.
- Formulated to be non-yellowing, non-crazing, non-cracking with excellent UV resistance and optical clarity.

- Protects driver and passenger from the elements.
- Quick and easy tool-less installation or removal.

Installation of some accessories shown may impact vehicle compliance with some regulations. Consult your local dealer for information.

NEW Half Windshield – Hardcoated

Traxter G1, Traxter G1 MAX, Traxter G2, Traxter G2 MAX

715010075

- High-impact-resistant Makrolon¹ hardcoated polycarbonate half windshield.
- Formulated to be non-yellowing, non-crazing, non-cracking with excellent UV resistance and optical clarity.

- Protects driver and passenger from the elements.
- Features reverse angle lip to deflect air flow.
- Quick and easy tool-less installation or removal.
- Not compatible with Soft Doors.

Installation of some accessories shown may impact vehicle compliance with some regulations. Consult your local dealer for information.

ProVent Windshield

Traxter G1, Traxter G1 MAX, Traxter G2, Traxter G2 MAX

715005276

- High-impact-resistant Quantum hardcoated polycarbonate full windshield.
- Optimal performance with Full Cab Enclosure.
- Controllable vents to manage air flow.
- Channels air into the cabin, defogs windshield, fully closes to eliminate air flow.

- 2 lower vents and one upper vent (pre-filter installed).
- Provides excellent optical clarity and better abrasion resistance.
- Protects driver and passenger from the elements.
- Quick and easy tool-less installation or removal.
- Not compatible with wiper kits.

Installation of some accessories shown may impact vehicle compliance with some regulations. Consult your local dealer for information.

NEW SMART Intermittent Wiper & Washer Kit	Traxter G2, Traxter G2 MAX	715009441
--	----------------------------	------------------



- An ideal way to keep your windshield clear in rain, or while riding through mud and water.
- Includes single-speed wiper, washer fluid dispenser and windshields frame mount.
- Automatic speed variation mode and intermittent wiper speed features available when the kit is installed in combination with ACM and that varies with vehicle speed.
- Must be used with the Glass Windshield (715010876) or Flip Glass Windshield (715009225).
- Requires Wiper and Power Cables when ACM is not installed:
 - If equipped with the Sport Roof, Power Cables (715010489 & 715009756) are required.
 - If equipped with the Audio Roof, Power Cable (715010324) is required.
- Included with Flip Glass Windshield with SMART Intermittent Wiper & Washer Kit (715009890).

Installation of some accessories shown may impact vehicle compliance with some regulations. Consult your local dealer for information.

Windshield Wiper & Washer Kit	Traxter G1, Traxter G1 MAX	715001638
--	----------------------------	------------------



- An ideal way to keep your windshield clear in rain, or while riding through mud and water.
- Includes single-speed wiper, washer fluid dispenser and windshields frame mount.
- Must be used with the Glass Windshield (715010876) or Flip Glass Windshield (715002942) or Powerflip Windshield (715003885).
- Requires Wiper and Power Cables: If equipped with the Sport Roof, Power Cables 710004462 & 715003094 are required. If equipped with the Audio Roof, Power Cables 715008781 & 715003094 are required.

Installation of some accessories shown may impact vehicle compliance with some regulations. Consult your local dealer for information.

NEW Wiper & Power Windows Cable	Traxter G2, Traxter G2 MAX	715009756
--	----------------------------	------------------

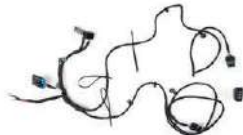

- Required to install Front Deluxe Full Doors (715010568 or 715010570) and/or Intermittent Wiper & Washer Kit (715009441).
- Necessary if you want to build your own cab enclosure from modular components.
- Not compatible with Audio Roof.

NEW Wiper & Power Windows Cable	Traxter G2, Traxter G2 MAX	715010324
--	----------------------------	------------------



- Required to install Front Deluxe Full Doors (715010568 or 715010570) and/or Intermittent Wiper & Washer Kit (715009441) with the Audio Roof.
- Necessary if you want to build your own cab enclosure from modular components.

Wiper & Power Windows Cable <i>(Not illustrated)</i>	Traxter G1, Traxter G1 MAX	715008781
--	----------------------------	------------------

- Required to install the Audio Roof (715005206 or 715006879) with the following accessories: Flip Glass Windshield with Wiper & Washer Kit (715002441), Windshield Wiper & Washer Kit (715001638) and Front Deluxe Full Doors (715009906 or 715009913).

Wiper & Power Windows Cable <i>(Not illustrated)</i>	Traxter G1, Traxter G1 MAX	710004462
--	----------------------------	------------------

- Required to install Front Deluxe Full Doors (715009906 or 715009913) and/or Windshield Wiper & Washer Kit (715001638).
- Necessary if you want to build your own cab enclosure from modular components.

Manual Wiper Kit	Traxter G1, Traxter G1 MAX, Traxter G2, Traxter G2 MAX	715008755
-------------------------	--	------------------



- Single manual wiper that can be used to clear windshield of debris.
- Easy to install system that requires no electrical hookup.
- Large ergonomic handle provides a good grip over the entire sweeping surface.
- Compatible with glass and hardcoated windshields that use top mounted wipers.

Installation of some accessories shown may impact vehicle compliance with some regulations. Consult your local dealer for information.

Side Wind Deflectors	Traxter G1, Traxter G1 MAX, Traxter G2, Traxter G2 MAX	715005081
-----------------------------	--	------------------



- Clear polycarbonate air deflectors mount on each side of the cage.
- Not compatible with Full Doors.
- Sold in pairs.
- Compatible with all windshields.
- Can be adjusted at three different positions for cabin air flow control when a full windshield is installed:
 1. Outside deflection to reduce cabin air flow and turbulence.
 2. Inside deflection to increase air flow in the cabin.
 3. Windshield ventilation to reduce fog.

MIRRORS

Side Mirrors

Traxter G1, Traxter G1 MAX, Traxter G2,
Traxter G2 MAX

■ **715008100** • Black



- Rugged black nylon 6/6 construction with coated cast-aluminum mount.
- Dual adjustment (horizontal and vertical) will suit any rider.
- Convex optics deliver optimal field of view (FOV).
- Spring-loaded pivots let mirrors fold back completely.
- Fit with and without doors and half doors.
- Sold in pairs.
- Not compatible with Soft Doors and Soft Cab Enclosures.

Side Mirror

Traxter G1, Traxter G1 MAX (2022 & up),
Traxter G2, Traxter G2 MAX

715008101*

Traxter G1, Traxter G1 MAX (2021 & prior)

715002459



- Molded heavy-duty aluminum mirror.
- Stays in place on rough trails.
- Ball-joint design for steady multi-angle adjustment and outstanding vision.
- Use with or without any roof, windshield or doors.
- Not for road use.
- Fits either side.
- Sold individually.

**Not compatible with the Half Doors (715006314 & 715006316).*

Installation of some accessories shown may impact vehicle compliance with some regulations. Consult your local dealer for information.

Panoramic Center Mirror

Traxter G1, Traxter G1 MAX, Traxter G2,
Traxter G2 MAX

715003638



- Wide-angle convex mirror.
- Offers enhanced visibility.
- Can be used with or without roof or windshield and with cab enclosures.

Mirrors Adaptor





(Not illustrated)

All Clear Rigid Cabs

715009750

- Needed to re-use mirrors coming with the unit when installing a Clear Rigid Cab.

REAR WIND PROTECTION

Rear Glass Window with Sliding Panel	Traxter G1, Traxter G1 MAX (except X mr models), Traxter G2, Traxter G2 MAX	715007080
	<ul style="list-style-type: none"> Made of high-strength tempered glass. Ideal for preventing backdraft of dust or rain in harsh environments. Sliding panel for enhanced ventilation. Quick and easy installation. Sport Roof (715002430 or 715003038) required for installation. Not compatible with Snorkel Kit. 	
Rear Glass Window	Traxter G1, Traxter G1 MAX (except X mr models), Traxter G2, Traxter G2 MAX	<input checked="" type="checkbox"/> 715009915 • Tinted <input type="checkbox"/> 715007079 • Clear
	<ul style="list-style-type: none"> Made of high-strength tempered glass. Ideal for preventing backdraft of dust or rain in harsh environments. Quick and easy installation. Sport Roof (715002430 or 715003038) required for installation. Not compatible with Snorkel Kit. Tinted glass 14% VLT (visual light transmission). Rear Wind Protection Installation Seal Kit (715006705) required for installation on 2020 Traxter models. 	
Rear Polycarbonate Window	Traxter G1, Traxter G1 MAX (except X mr models), Traxter G2, Traxter G2 MAX	715009325
	<ul style="list-style-type: none"> High-impact-resistant polycarbonate window. Ideal for preventing backdraft of dust or rain in harsh environments. Quick and easy installation. Sport Roof (715002430 or 715003038) required for installation. 	
Rear Wind Screen	Traxter G1, Traxter G1 MAX, Traxter G2, Traxter G2 MAX	715002851
	<ul style="list-style-type: none"> Full rear mesh screen reduces windshield backdraft for added cabin comfort. Installs quickly and easily on roll cage. White Can-Am logo at top, to help maintain clear view. 	
Soft Rear Window	Traxter G1, Traxter G1 MAX, Traxter G2, Traxter G2 MAX	715003249
	<ul style="list-style-type: none"> Clear, flexible window made of see-through vinyl. Resists cold cracking to -4°F (-20°C). Blocks windshield backdraft or dust and rain from entering, for added cabin comfort. Installs quickly and easily on roll cage. White Can-Am logo at top, to help maintain clear view. 	

DOORS

NEW Front Deluxe Full Doors

Traxter G2 (except X mr models),
Traxter G2 MAX (except X mr models)

715010568 • Clear
 715010570 • Tinted



- Premium doors made from robust polyethylene.
- Offer excellent protection from the elements.
- Key locking door latches.
- Tinted glass 14% VLT (visual light transmission).
- Easy to remove on hot and sunny days.
- Convenient integrated storage areas.
- Doors' curved design provides even more room.
- Rear-hinge wide opening for ease of ingress/egress in the cockpit.
- Power window delivers added ventilation.
- Compatible with all BRP windshields.

- Requires for installation:
- Wiper and Doors Wiring Harness (715009756) for Sport Roof or the Wiper and Doors Harness (715010324) for Audio Roof.
- Cable Cover and Roof Power Cable Kit (715010489).
- Front Roof Liner (715009196) and Sport Roof Seal Kit (715003126).
- Color Door Trims are required (sold separately).
- Hardware to install the Door Trims is included.

Installation of some accessories shown may impact vehicle compliance with some regulations. Consult your local dealer for information.

Front Deluxe Full Doors

Traxter G1 (except X mr models),
Traxter G1 MAX (except X mr models)

715009906 • Clear
 715009913 • Tinted



- New key locking door latches.
- Premium doors made from robust polyethylene.
- Offer excellent protection from the elements.
- Tinted glass 55% VLT (visual light transmission).
- Easy to remove on hot and sunny days.
- Convenient integrated storage areas.
- Doors' curved design provides even more room.
- Rear-hinge wide opening for ease of ingress/egress in the cockpit.
- Power window delivers added ventilation.

- Compatible with all BRP windshields.
- Require Wiper & Power Windows Cable (710004462), Roof Power Cable (715003094), Sport Roof Seal Kit (715003126).
- If equipped with the Audio Roof, the Wiper & Power Windows Cable (715008781) is required.
- Color Door Trims are required (sold separately).
- Hardware to install the Door Trim is included.

Installation of some accessories shown may impact vehicle compliance with some regulations. Consult your local dealer for information.

NEW Rear Deluxe Full Doors

Traxter G2 MAX

715010569 • Clear
 715010571 • Tinted



- New key locking door latches.
- Premium doors made from robust polyethylene.
- Offer excellent protection from the elements.
- Tinted glass 14% VLT (visual light transmission)
- Easy to remove on hot and sunny days.
- Convenient integrated storage areas.
- Doors' curved design provides even more room.
- Rear-hinge wide opening for ease of ingress/egress in the cockpit.
- Roll-Down Window delivers added ventilation.

- Require Front Doors (715010568) or Front Deluxe Full Doors – Tinted Glass (715010570), Wiper and Doors Wiring Harness (715009756) for Sport Roof or the Wiper and Doors Harness (715010324) for Audio Roof.
- Cable Cover and Roof Power Cable Kit (715010489).
- Front Roof Liner (715009196) and Sport Roof Seal Kit (715003126).
- Color Door Trims are required (sold separately).
- Hardware to install the Door Trim is included.

Rear Deluxe Full Doors

Traxter G1 MAX 2022 & up (models produced after January 18, 2021) (except X mr models)

715009907 • Clear
 715009914 • Tinted



- New key locking door latches.
- Premium doors made from robust polyethylene.
- Offer excellent protection from the elements.
- Tinted glass 14% VLT (visual light transmission).
- Easy to remove on hot and sunny days.
- Convenient integrated storage areas.
- Doors' curved design provides even more room.
- Rear-hinge wide opening for ease of ingress/egress in the cockpit.

- Roll-Down Window delivers added ventilation.
- Require Front Deluxe Full Doors (715009906 or 715009913), Wiper & Power Windows Cable (710004462), Roof Power Cable (715003094), Sport Roof Seal Kit (715003583 for MAX vehicle).
- Color Door Trims are required (sold separately).
- Hardware to install the Door Trim is included.

Front Deluxe Half Doors

Traxter G2, Traxter G2 MAX
Traxter G1, Traxter G1 MAX (2022 & up)

715010572 **NEW**
715007201



- Premium color matching doors made from robust polyethylene.
- Premium fit and finish.
- Slim with interior pockets.
- Rear hinge wide opening for ease of ingress/egress in the cockpit.

- Interior and exterior handles.
- Color accent panels are required (sold separately).
- Hardware to install the Door Trim is included.

Installation of some accessories shown may impact vehicle compliance with some regulations. Consult your local dealer for information.

Rear Deluxe Half Doors

Traxter G2 MAX

715010573 NEW

Traxter G1, Traxter G1 MAX (2022 & up)

715007202



- Premium color matching doors made from robust polyethylene.
- Premium fit and finish.
- Slim with interior pockets.
- Rear hinge wide opening for ease of ingress/egress in the cockpit.
- Interior and exterior handles.
- Color accent panels are required (sold separately).
- Hardware to install the Door Trims is included.

NEW Front Trims

Traxter G2, Traxter G2 MAX



Customize your Traxter by adding color-matched door panels.

- Front color-matched panel for full and half doors.
- Front Deluxe Full Doors (715010568), Front Deluxe Full Doors – Tinted Glass (715010570) or Front Deluxe Half Doors (715010572) are required.

Front Left Door Trim

Front Right Door Trim

■ **705801224** • Stealth Black **NEW**

■ **705801225** • Stealth Black **NEW**

■ **705801269** • Dark Wildland Camo **NEW**

■ **705801270** • Dark Wildland Camo **NEW**

■ **705801551** • Dusty Navy **NEW**

■ **705801552** • Dusty Navy **NEW**

NEW Rear Trims

Traxter G2 MAX



Customize your Traxter by adding color-matched door panels.

- Rear color-matched panel for full and half doors.
- Rear Deluxe Full Doors (715010569), Rear Deluxe Full Doors – Tinted Glass (715010571) or Rear Deluxe Half Doors (715010573) are required.

Rear Left Door Trim

Rear Right Door Trim

■ **705801234** • Stealth Black **NEW**

■ **705801235** • Stealth Black **NEW**

■ **705801271** • Dark Wildland Camo **NEW**

■ **705801272** • Dark Wildland Camo **NEW**

■ **705801275** • Dusty Navy **NEW**

■ **705801276** • Dusty Navy **NEW**

Front Trims

Traxter G1, Traxter G1 MAX



Customize your Traxter by adding color-matched door panels.

- Front Deluxe Full Doors (715009906), Front Deluxe Full Doors– Tinted Glass (715009913) or Front Deluxe Half Doors (715007201) are required.

Front Left Door Trim

Front Right Door Trim

■ **705801617** • Dark Wildland Camo **NEW**

■ **705801618** • Dark Wildland Camo **NEW**

■ **705801565** • Dusty Navy

■ **705801566** • Dusty Navy

■ **705801303** • Stealth Black

■ **705801305** • Stealth Black

■ **705801330** • Compass Green

■ **705801331** • Compass Green

■ **705801504** • Timeless Black

■ **705801505** • Timeless Black

■ **705801340** • Fiery Red

■ **705801341** • Fiery Red

■ **705801408** • Hyper Silver

■ **705801409** • Hyper Silver

Rear Trims

Traxter G1 MAX



Customize your Traxter by adding color-matched door panels.

- Rear Deluxe Full Doors (715009907), Rear Deluxe Full Doors – Tinted Glass (715009914) or Rear Deluxe Half Doors (715007202) are required.

Rear Left Door Trim

Rear Right Door Trim

■ **705801619** • Dark Wildland Camo **NEW**

■ **705801620** • Dark Wildland Camo **NEW**

■ **705801567** • Dusty Navy

■ **705801568** • Dusty Navy

■ **705801307** • Stealth Black

■ **705801309** • Stealth Black

■ **705801332** • Compass Green

■ **705801333** • Compass Green

■ **705801506** • Timeless Black

■ **705801507** • Timeless Black

■ **705801342** • Fiery Red

■ **705801343** • Fiery Red

■ **705801410** • Hyper Silver

■ **705801411** • Hyper Silver

NEW Front Clear Rigid Doors

Traxter G1, Traxter G1 MAX, Traxter G2, Traxter G2 MAX

715010067



- Sturdy and compact steel frame doors for a robust yet open field of view.
- Lower hardcoated polycarbonate transparent panel maximizes visibility around your unit.
- Upper portion composed of two tempered-glass sliding windows for unmatched air circulation and versatility.
- EC and ROHVA-compliant for optimal safety, allowing you to remove the stock side protection bar for increased cabin space.
- Sealed contour allows for improved rider comfort in all weather.
- Lockable doors for peace of mind.

Installation of some accessories shown may impact vehicle compliance with some regulations. Consult your local dealer for information.

Rear Clear Rigid Doors	Traxter G1 MAX 2022 & up (except X mr models), Traxter G2 MAX	715006262
-------------------------------	--	------------------



- Sturdy and compact steel-frame doors for a robust yet open field of view.
- Lower hardcoated polycarbonate transparent panel maximizes visibility around your unit.
- Upper portion composed of two tempered-glass sliding windows for unmatched air circulation and versatility.
- EC- and ROHVA-compliant for optimal safety, allowing you to remove the stock side protection bar for increased cabin space.
- Sealed contour allows for improved rider comfort in all weather.
- Lockable doors for peace of mind.

Half Doors	Traxter G1, Traxter G2	715010076 - 2 doors NEW
	Traxter G1 MAX, Traxter G2 MAX	715010077 - 4 doors NEW



- Half doors made of plastic.
- Metal frame for a higher level of fit and finish and rigidity.
- Rear hinge wide opening for ease of ingress/egress in the cockpit.
- Interior pockets and liners for more comfort.

Installation of some accessories shown may impact vehicle compliance with some regulations. Consult your local dealer for information.

NEW Soft Doors Can-Am	Traxter G1, Traxter G1 MAX, Traxter G2, Traxter G2 MAX	715009895 - 2 front doors
	Traxter G1 MAX 2018 & prior, 2022 & up (models produced after January 18, 2021), G2 MAX	715009896 - 2 rear doors



- The design has been improved to enhance functionality.
- Weather-resistant soft doors reinforced with steel frame offer good protection from the elements.
- Made of heavy-duty UV-resistant canvas for excellent resistance to tear and abrasion.
- Rear hinge wide opening for ease of ingress/egress.
- Zip-down windows made of laminated polished vinyl material for added ventilation.
- Quick and easy installation, and easily removable on hot sunny days.
- Compatible with BRP roofs and mirrors.

Soft Door Installation Kit (715006238 / 2X for MAX) is required for installation of 2019 and prior doors on 2020 Traxter models.

Installation of some accessories shown may impact vehicle compliance with some regulations. Consult your local dealer for information.

Front Deluxe Door Locks	Traxter G1, Traxter G1 MAX	715009951
--------------------------------	----------------------------	------------------



- Allow you to upgrade your deluxe doors with integrated door locks.
- Include a pair of locks for front doors.
- Included on Deluxe Doors and Deluxe Cab Kits 2025 and over.
- 2 keys included.

Front & Rear Deluxe Door Locks	Traxter G1 MAX	715009952
---	----------------	------------------

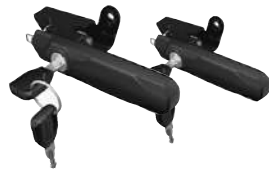

- Allow you to upgrade your deluxe doors with integrated door locks.
- Include 4 locks for front and rear doors.
- Included on Deluxe Doors and Deluxe Cab Kits 2025 and over.
- 2 keys included.

SEAT ACCESSORIES

Central Headrest

Traxter G1, Traxter G1 MAX, Traxter G2,
Traxter G2 MAX

715005163



- Headrest for front-center-seating position on 3-seated models and for rear-center-seating position on MAX models.
- Front Headrests are available separately for front passengers on MAX models.
- Headrests are required for all passengers on some regulated trails.
- Not CE Compliant.

Headrests are required for all passengers on some regulated trails.

Front Headrests

Traxter G1 MAX, Traxter G2 MAX

715005164



- Additional headrest for all three front-seating positions on MAX models.
- Central Headrest is available separately for rear-center-seating positions on MAX models.
- Headrests are required for all passengers on some regulated trails.
- Not CE Compliant.

Headrests are required for all passengers on some regulated trails.

ALUMINUM SKID PLATES

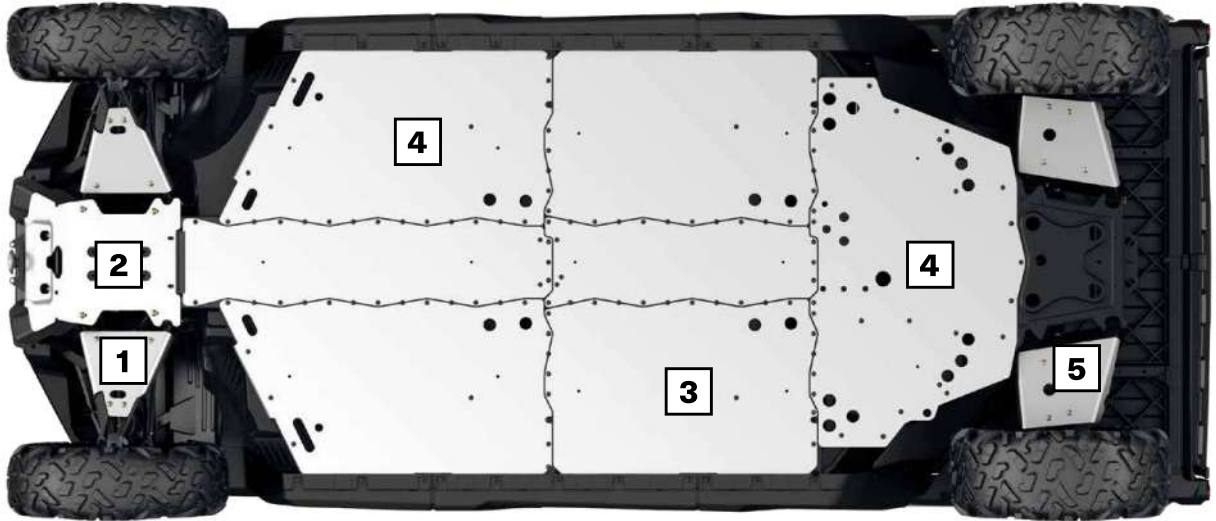

For ultimate durability and strength, all our Aluminum Skid Plates are made with High Strength 5052 H32 Aluminum $\frac{3}{16}$ " (4.5 mm) thick.

- Ultimate durability
- High strength

TRAXTER, TRAXTER MAX

	2019 & prior		2020 & up			2026
	Front suspension type					
	Double A-Arm (Traxter G1)	Arched double A-Arm with Swaybar (Traxter G1)	Double A-Arm (Traxter G1)	Arched double A-Arm (Traxter G1)	Arched double A-Arm with Swaybar (Traxter G1)	Arched double A-Arm with Swaybar (Traxter G2)
Offer your Traxter the full protection kit or get parts individually						
FULL PROTECTION KIT						
Aluminum Skid Plate Protection Kit	715003711 (except MAX)	715006977 (3-up)	715006694 (except MAX)	715006696 (3-up & 6x6)	715006979 (3-up 2020 to 2021 only)	715009141
	715003712 (MAX only)	715006978 (MAX)	715006695 (MAX only)	715006697 (MAX & PRO)	715006980 (MAX 2020 to 2021 only)	
INDIVIDUAL ALUMINUM SKID PLATES						
1 Front A-Arm Protectors	715008274	715006975	715008274	715004387	715004387 (2022 & up)	715009404 (compatible with Apache XC LT Track System)
<ul style="list-style-type: none"> • Extra underside protection for your vehicle's steering mechanism and suspension (A-arm). • Sold in pairs. • Not compatible with Apache Track Systems. 					715006975 (2020 to 2021 only)	
2 Front Skid Plate	715002447	715002447	715002447	715002447	715002447	715009137 (not compatible with plow)
<ul style="list-style-type: none"> • Protects the front underside of your vehicle when riding in rough terrain conditions. • Adds style to the front of your vehicle. 						
3 Central Skid Plate	715003467 (MAX only)	715003467 (MAX only)	715003467 (MAX & PRO only)	715003467 (MAX & PRO only)	715003467 (MAX & PRO only)	N/A *Already coming with a thick and robust skid plate
<ul style="list-style-type: none"> • Central Skid Plate Kit includes central and lateral skid plates. • Ultra-durable protection for the underside of your vehicle. • Makes work easy in more demanding terrain. • Must be used with Underbelly Skid Plate Kit. 					715003467 (MAX & PRO only)	
4 Underbelly Skid Plate Kit	715002446	715002446	715007982	715007982	715007982	N/A *Already coming with a thick and robust skid plate
<ul style="list-style-type: none"> • Ultra-durable protection for the underside of your vehicle. • Makes work easy in more demanding terrain. • Kit includes central, lateral and rear skid plates. 						
5 Rear A-Arm Protectors	715002445	715006976	715002445	715004388	715004388 (2022 & up)	715009405 (compatible with Apache XC LT Track System)
<ul style="list-style-type: none"> • Extra underside protection for your vehicle's suspension (A-arm). • Sold in pairs. • Not compatible with Apache Track Systems. 					715006976 (2020 to 2021 only)	

BUMPERS & GUARDS

BUMPERS

NEW Large Heavy-Duty Front Bumper

Traxter G2, Traxter G2 MAX

715009164



- 1.5" (3.8 cm) diameter steel-tube construction.
- Provides heavy-duty protection.
- Inside and outside anti-corrosion coating with durable powder coat finish.
- Integrated mounting point for SMART 10" (25 cm) LED Light Bar (715008745).
- Standard on all Lone Star and Limited Cab models.

Front Bumper

Traxter G1, Traxter G1 MAX (2019 & prior)

715002418

Traxter G1, Traxter G1 MAX (2020 & up)

715005754



- Heavy-duty 1.5" (3.8 cm) diameter steel-tube construction.
- Provides enhanced protection.
- Inside and outside anti-corrosion coating with durable powder coat finish.
- Integrated mounting points for lights.
- Required to install the Xtreme Front Bumper Plates, Front Rack and the Front Corner Protectors.

Xtreme Front Bumper Plates

Traxter G1, Traxter G1 MAX (2019 & prior)[†]

715003005

Traxter G1, Traxter G1 MAX (2020 & up)[‡]

715005777



- Made of high-strength heavy-gauge steel with rubber pads for increased protection.
- Inside and outside anti-corrosion coating with durable powder coat finish.
- Provide additional front-end protection.

[†]Require Front Bumper (715002418) for installation.

[‡]Require Front Bumper (715005754) for installation.

Installation of some accessories shown may impact vehicle compliance with some regulations. Consult your local dealer for information.

Front Corner Protectors

Traxter G1, Traxter G1 MAX (2019 & prior)[†]

715002833

Traxter G1, Traxter G1 MAX (2020 & up)[‡]

715005774



- Heavy-duty 1.25" (3.2 cm) diameter steel-tube construction.
- Provide enhanced protection for front corners.
- Inside and outside anti-corrosion coating with durable powder coat finish.
- Sold in pairs.

[†]Require Front Bumper (715002418) for installation.

[‡]Require Front Bumper (715005754) for installation.

Rancher Front Bumper

Traxter G1, Traxter G1 MAX

715005410



- The low front-end protection and plates allow you to use your vehicle within cattle herds and guard the safety of both the vehicle and the animals.
- The flat front portion facilitates gently prodding cattle or pushing light objects, e.g., closing a fence.
- The full frontage coverage extends to provide an extra layer of defense to your headlights and radiator.
- Inside and outside anti-corrosion coating with durable powder coat finish.

Traxter, Traxter MAX (2020 & up)

- Improved approach angle.
- Compatible with front rack, snow plows, tire and track kits, winches.

Installation of some accessories shown may impact vehicle compliance with some regulations. Consult your local dealer for information.

XT Front Bumper

Traxter G1, Traxter G1 MAX (2019 & prior)

715004407



- 1.5" (3.8 cm) diameter steel-tube construction.
- Provides light-duty protection.
- Inside and outside anti-corrosion coating with durable powder coat finish.
- Light-kit compatible.
- Standard on XT and XT Cab models 2018 and 2019.
- Not compatible with Xtreme Front Bumper Plates, Front Corner Protectors or LinQ® Front Rack.

X mr Front Bumper

Traxter G1, Traxter G1 MAX

715006143 • Black



- Heavy-duty 1.5" (3.8 cm) diameter steel-tube construction.
- Inside and outside anti-corrosion coating with durable finish.
- Provides additional front body protection.
- Integrated winch support plate for winch relocation at a higher position for easier access in muddy conditions or for auxiliary lights.

- Includes a front tow hook.
- Standard on X mr models.
- Winch sold separately.

Cargo Bed Protectors & Tie Rails

Traxter G1 (6x6 & PRO models only)

715005415

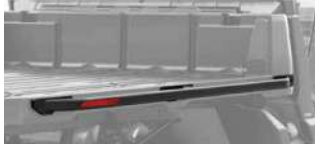

- Heavy-duty 1.5" (3.8 cm) diameter steel-tube construction.
- Reliable cargo box protection and tie-down attachment point to secure large loads.
- Anti-corrosion coating with durable powder coat finish.
- Designed to stay in place when cargo bed side walls are removed.

NEW Rear Bumper

Traxter G2, Traxter G2 MAX

715009158



- Heavy-duty 1.5" (3.8 cm) diameter steel construction and integrated tubular design.
- Integrated lower and upper grip step for easy access to the cargo bed.
- Increased protection of rear cargo box and lower box corner while allowing normal tailgate function.
- Inside and outside anti-corrosion coating with durable powder-coat finish.

Rear Bumper

Traxter G1, Traxter G1 MAX

715008109



- Heavy-duty 1.5" (3.8 cm) diameter steel construction and integrated tubular design.
- Increased protection of rear box and lower box corner while allowing normal tailgate function.
- Inside and outside anti-corrosion coating with durable powder-coat finish.
- Required to install Rear Body Side Protector (715003055).

Rear Bumper Adapter

(Not illustrated)

Traxter G1 (6x6 & PRO models only)

715006060

- Required to install the Rear Bumper on Traxter models with the long box.

Rear Body Side Protectors

Traxter G1, Traxter G1 MAX

715003055



- Heavy-duty 1.5" (3.8 cm) diameter steel-tube construction.
- Reliable cargo box protection.
- Inside and outside anti-corrosion coating with durable powder coat finish.
- Compatible with fender flares.
- Integrated brush and low-lying branch deflector.
- Require Rear Bumper for installation.
- Sold in pairs.

BODY SIDE PROTECTORS

Front Body Side Protectors

Traxter G1, Traxter G1 MAX

715003450



- Heavy-duty 1.25" (3.2 cm) diameter steel-tube construction.
- Front side protection for farm, ranch and forestry applications.
- Offer complete front body protection.
- Inside and outside anti-corrosion coating with durable powder coat finish.
- Sold in pairs.
- Require Front Bumper (715002418 or 715005754) with Front Corner Protectors (715002833 or 715005774) and Rock Slider (715002569 or 715003040 for MAX models) for installation.

Front Rancher Body Side Protectors

Traxter G1, Traxter G1 MAX

715003617



- Heavy-duty 1.25" (3.2 cm) diameter steel-tube construction.
- Front side protection for farm, ranch and forestry applications.
- Offer complete front body protection.
- Inside and outside anti-corrosion coating with durable powder coat finish.
- Sold in pairs.
- Require Rancher Bumper and Rock Sliders for installation.

FENDER FLARES

Fender Flares	Traxter G1 (except 6x6 & PRO), Traxter G1 MAX	715006821
	Traxter G1 6x6	715005409
	Traxter G1 PRO	715006001
	Traxter G2, Traxter G2 MAX	715009177 NEW



- Robust injection-molded polypropylene construction.
- Perfect for keeping mud and debris outside the vehicle.
- Include front and rear extension, and all mounting hardware.
- Ideal for track equipped vehicles.

Sport Fender Flares	Traxter G1 (except 6x6 & PRO), Traxter G1 MAX	715003898
----------------------------	--	------------------



- Sleek fender flares just the right size to reduce mud and debris kick-up from your tires.
- Robust injection-molded polypropylene construction.
- Include front and rear extension, and all mounting hardware.

ROCK SLIDERS

NEW X mr / Lone Star Rock Sliders	Traxter G2	715009421
	Traxter G2 MAX	715010031



- Rock sliders made of painted 2 mm steel with an integrated step for elevated cargo box access.
- Protect vehicle's sides and undercarriage against large obstacles.
- Lodge tight up against vehicle body for better clearance from obstacles.
- Standard on Traxter G2 X mr and Lone Star models.
- Sold in pairs.

Rock Sliders	Traxter G1	■ 715006671 • Black
	Traxter G1 MAX, G1 PRO	■ 715006721 • Black



- Heavy-duty rock sliders made of painted $\frac{3}{16}$ " (5 mm) aluminum with an integrated step for elevated cargo box access.
- Protect vehicle's sides and undercarriage against large obstacles.
- Lodge tight up against vehicle body for better clearance from obstacles.
- Not compatible with other rock sliders.
- Sold in pairs.
- Standard on Traxter X mr, Traxter MAX X mr and Traxter XT-P models.

Rock Sliders	Traxter G1, G1 6x6	715002569
	Traxter G1 MAX, G1 PRO	715003040



- Protect vehicle's sides and undercarriage against large obstacles.
- Made of heavy-duty 1.5" (3.8 cm) diameter steel tubing.
- Inside and outside anti-corrosion coating with durable powder coat finish.
- Integrated step for easy cargo box access.
- Sold in pairs.

MUD FLAPS

Mud Flaps	Traxter G1, Traxter G1 MAX	715003041
------------------	----------------------------	------------------



- Keep mud and debris out of cargo area and protect trailer or vehicles behind you.
- Add aesthetic appeal to your vehicle.
- Made of EPDM rubber.
- Require Rear Bumper for installation.
- Sold in pairs.



LINQ SYSTEM

The LinQ system offers tool-free, near-instant attachment for a wide range of accessories. Quickly adapt your side-by-side for any adventure, knowing your gear stays secure, no matter how rough the trail gets.

OPTIMIZED STORAGE WITH TRAXTER G2

Trail-ready straight from the box, the Traxter G2 Cargo Box includes strategically pre-marked mounting points for easy rig customization, no matter your chosen system.



COUNTLESS OPTIONS

LinQ ORIGINAL SYSTEM

is compatible with all medium- to large-sized accessories, including 16" and 36" base units.

LinQ LITE

is designed for compact, on-the-go storage (max. 4.5 lb (2 kg) per latch). It lets you mount accessories to rails or vertical surfaces.

LINQ: EASY ON, EASY OFF CARGO

TRAXTER LinQ ACCESSORY MOUNTING LOCATIONS AND REQUIREMENTS

<ul style="list-style-type: none"> No tools needed: Quickly install and remove accessories by hand. Equip your Can-Am for specialized tasks in no time. Sturdy mounting system that holds up to the roughest terrain. 	TRAXTER G1				TRAXTER G2		
	Cargo Bed (long box bed LinQ) G1 6x6 & PRO	LinQ Cargo Rack 715006140	Adventure Roof Rack 715003870 / 715004391	Loadout Rack 715005447	Cargo Bed (short box bed LinQ)	Cargo Rack 715009148 / 715009170	
LinQ ACCESSORIES WITH 16" BASE <ul style="list-style-type: none"> LinQ anchors mounted 16 inches apart, center-to-center. Lower loading capacity than the LinQ with 36" base accessories. Can be used on Can-Am ATV and SxS vehicles, Can-Am Spyder and Ryker vehicles, Sea-Doo watercraft and Ski-Doo snowmobiles. 							
NEW LinQ Fuel Caddy 5 Gal (20 L) 715007822	LinQ Base Installation Kit 715008125	LinQ Base Installation Kit 715008125	No compatibility	No compatibility	LinQ Base Installation Kit 715008125	LinQ Base Installation Kit 715008125	
NEW LinQ Fuel Caddy 3.8 Gal (14.5 L) 295100950			LinQ Base Installation Kit 715008125	LinQ Base Installation Kit 715008125			
NEW LinQ Rigid Cooler 4.7 US Gal (18 L) 715010491 • Black		No compatibility	No compatibility	No compatibility		No compatibility	
NEW LinQ Cooler 5.3 Gal (20 L) 295101257 • Gray							
LinQ Cooler 11.4 Gal (43 L) 715007825 • Black 715009276 • Gray		LinQ Base Installation Kit 715008125	LinQ Base Installation Kit 715008125	LinQ Base Installation Kit 715008125		LinQ Base Installation Kit 715008125	LinQ Base Installation Kit 715008125
LinQ Tool Kit 715006829							
LinQ Tool Box 715008111							
LinQ SR Bag 5.5 Gal (21 L) 860202449							
LinQ Sport Bag 4.5 Gal (17 L) 860202447							
LinQ Modular Box 715005494 • (10 L) 715007112 • (20 L) 715006830 • (30 L)							
LinQ Roll-Top Bag 10.5 Gal (40 L) 715008110							
LinQ Explorer Bag 26 Gal (100 L) 295101016							
LinQ Semi-Rigid Cooler 5.3 Gal (20 L) 295101252	No compatibility	No further requirements	LinQ Base Installation Kit 715008125	LinQ Base Installation Kit 715008125			
	LinQ Base Installation Kit 715008125	LinQ Base Installation Kit 715008125					
LinQ ACCESSORIES WITH 36" BASE <ul style="list-style-type: none"> Mount on LinQ racks often used by Can-Am ORV vehicles. Higher loading capacity than the LinQ with 16" base accessories. Usage is limited to Can-Am ORV vehicles. 							
LinQ Cargo Box 12 Gal (45 L) 715003879	No compatibility	No compatibility	No compatibility	No compatibility	No compatibility	No compatibility	
LinQ Trunk Box 23 Gal (86 L) 715004923							
LinQ Audio Cargo Box 11.5 Gal (43 L) 715003018							
LinQ Cargo Box 14 Gal (53 L) 715006997							
LinQ Cooler Box 8 Gal (30 L) 715004778 • Black							
LinQ Cooler Box 9.2 Gal (35 L) 715006998 • Black							
LinQ Premium Storage Bag by OGIO 715002923 • Black							
LinQ Heavy Duty Basket 715001215							
LinQ Low Profile Basket 715004282							
NEW LinQ Cargo Basket 23 Gal (90 L) 715005274							No compatibility
LinQ HOLDERS							
LinQ Gear Grips 715005340	No further requirements	No further requirements	Side wall installation LinQ Adapters 715003058	Side wall installation LinQ Adapters 715003058	No further requirements	No further requirements	
LinQ Tool Holder 715007358							

LinQ ACCESSORIES WITH 16" BASE

NEW LinQ 5 US Gal (20 L) Fuel Caddy

Traxter G1, Traxter G1 MAX, Traxter G2,
Traxter G2 MAX

715007822



- Quick, easy and secure LinQ system installation.
- Spill-free spout for easy use.
- 5 US gal (20 L) capacity.
- Meets new Flame Mitigation Device (FMD) standard.
- Dimensions: 12" L x 19" W x 12" H.
- Check local regulations regarding fuel transportation

NEW LinQ 3.8 US Gal (14.5 L) Fuel Caddy

Traxter G1, Traxter G1 MAX, Traxter G2,
Traxter G2 MAX

295100950



- Quickly and easy, secure installation with the LinQ accessory system.
- No-spill spout designed for easy pouring.
- 3.8 US gal (14.5 L) capacity.
- Dimensions: 13" L x 19" W x 9" H.
- Note: Fuel caddies cannot be stacked.
- Check local regulations regarding fuel transportation

NEW LinQ Rigid Cooler 4.7 US Gal (18 L)

Traxter G1, Traxter G1 MAX, Traxter G2,
Traxter G2 MAX

715010491



- Versatile LinQ 16" configuration fits many vehicles.
- Durable rotomolded rigid construction.
- Molded-in handles for quick installation and removal.
- High quality insulation for optimal ice retention.
- Sealed lid for airtight, weather-tight closure.
- Ergonomic and secure latch system offers excellent sealing.
- 4.7 US gal (18 L) capacity.

NEW LinQ Cooler 5.3 US Gal (20 L)

Traxter G1, Traxter G1 MAX, Traxter G2,
Traxter G2 MAX

295101257



- LinQ-mounted for fast, easy and secure storage.
- Locks in place with just a quarter turn.
- High-quality insulation for optimal ice retention.
- Keeps ice cold for 5 days.
- Rotomolded construction for exceptional rigidity and durability.
- Sealed lid for airtight, weather-tight closure.
- Rigid handles make transportation easy.
- Horizontal locking handles allow for installation of LinQ Lite accessories.

- Holds thirty-four 355 ml cans.
- 5.3 US gal (20 L) capacity.
- Exterior dimensions: 21" L x 15" W x 14" H (52 cm L x 38 cm W x 35 cm H).
- Interior dimensions: 15" L x 10" W x 9" H (39 cm L x 26 cm W x 23 cm H).
- LinQ Base Installation Kit (715008125) is required for installation.

Note: Cannot be mounted on the LinQ Stackable Fuel Caddy.

NEW LinQ Semi-Rigid Cooler 5.3 US Gal (20 L)

Traxter G1, Traxter G1 MAX, Traxter G2,
Traxter G2 MAX

295101252



- 5.3 US gal (20 L) of insulated, water-resistant capacity.
- Quick, easy and secure LinQ system installation.
- Attaches with one set of LinQ fasteners.
- Single day use soft cooler.
- Mesh pocket on top of the lid.

- Zippered pocket under the lid for quick and easy access.
- Removable interior for easy cleaning.
- Carry handles for easy transport.
- Can contain twelve 355 ml cans.
- Dimensions: 19" L x 13" W x 10" H.

LinQ 11.4 US Gal (43 L) Cooler

Traxter G1, Traxter G1 MAX, Traxter G2,
Traxter G2 MAX

■ 715007825 • Black
■ 715009276 • Gray



- Versatile LinQ 16" configuration fits many vehicles.
- High quality injection-molded impact resistant polypropylene outer shell for exceptional durability.
- High quality insulation for optimal ice retention.
- Thicker insulation on bottom to isolate vehicle heat.
- 11.4 US gal (43 L) capacity.
- LinQ-mounted for fast, easy, secure storage.
- Locks in place with only a quarter turn.
- Rigid handles make transportation easy.
- Horizontal locking handles allow installation of LinQ Lite accessories.

- Dry-basket included to protect items.
- Drain plug at the bottom to evacuate water.
- New ergonomic and secure latch system offers excellent sealing.
- Possibility to lock the cooler with a padlock.
- See table for installation location and requirements.

LinQ Modular Box	Traxter G1, Traxter G1 MAX, Traxter G2, Traxter G2 MAX	715005494 • (10 L)
		715007112 • (20 L)
		715006830 • (30 L)



- Allows stacking of other modular boxes to always have the right gear accessible.
- Always have the right box size to fit everything.
- Can be installed on any LinQ base with a 16" width.
- See table for installation location and requirements.

Thermal Insert for LinQ Modular Box (10 L)	Traxter G1, Traxter G1 MAX, Traxter G2, Traxter G2 MAX	219401110
---	---	------------------



- Insulated liner.
- Fits very well in the LinQ Modular Box (10 L).
- Can contain seven 355 ml cans.
- Keeps ice cold for one day.
- Interior dimensions: 9" L x 17" W x 2½" H.

LinQ Tool Box	Traxter G1, Traxter G1 MAX, Traxter G2, Traxter G2 MAX	715008111
----------------------	---	------------------



- High precision injected HDPE construction provides rigidity and durability.
- 5 gal (19 L) maximum capacity.
- Weather-resistant, sealed and lockable cover.
- Easy one-second on/off tool-less system.
- All the benefits of LinQ—simple, fast and secure.
- See table for installation location and requirements.

LinQ Tool Kit	Traxter G1, Traxter G1 MAX, Traxter G2, Traxter G2 MAX	715006829
----------------------	---	------------------



- Includes:
- Cutter pliers
 - Long-nose pliers
 - Locking pliers
 - Ratchet wrench ¾" drive
 - 6" ratchet extension
 - Integrated CVT belt storage location (belt not included)
 - Long-socket 19 mm ¾" drive – 6 pts
 - Socket 18 mm ¾" drive
 - Long-socket 17 mm ¾" drive – 6 pts
 - Socket 15 mm ¾" drive
 - Socket 13 mm ¾" drive
 - Socket 10 mm ¾" drive
 - Socket 8 mm ¾" drive
 - Socket Torx T40 ¾" drive
 - Socket Torx T30 ¾" drive
 - Socket Torx T20 ¾" drive
 - Breaker bar ¾" drive
 - Combination wrench set:
 - Wrench 19 mm
 - Wrench 18 mm
 - Wrench 15 mm
 - Wrench 13 mm
 - Wrench 10 mm
 - Wrench 8 mm
- See table for installation location and requirements.

LinQ SR 5.5 Gal (21 L) Bag	Traxter G1, Traxter G1 MAX, Traxter G2, Traxter G2 MAX	860202449
-----------------------------------	---	------------------



- Semi-rigid expandable bag.
- All the benefits of LinQ—simple, fast and secure.
- Easy one-second on/off tool-less system.
- Requires LinQ Base Installation Kit.
- 5.5 gal (21 L) capacity.
- See table for installation location and requirements.

LinQ 4.5 Gal (17 L) Sport Bag	Traxter G1, Traxter G1 MAX, Traxter G2, Traxter G2 MAX	860202447
--------------------------------------	---	------------------



- All the benefits of LinQ—simple, fast and secure.
- 4.5 US gal (17 L) capacity.
- Thermoformed bag base in HDPE (High Density Polyethylene) providing rigidity and durability.
- Rigid bottom, semi-rigid top.
- Easy one-second on/off tool-less system.
- See table for installation location and requirements.

LinQ Roll-Top Bag	Traxter G1, Traxter G1 MAX, Traxter G2, Traxter G2 MAX	715008110
--------------------------	---	------------------





- Fully waterproof roll-top dry bag will securely store and confine your equipment.
- LinQ mounted using heavy-duty rigid plastic base.
- High capacity storage solution (40 L).
- Bottom foam liner for additional equipment protection.
- Integrated handle for easy transportation on/off the vehicle.
- Dimensions: 14" L x 19" W x adjustable H.
- See table for installation location and requirements.

LinQ Explorer Bag	Traxter G1, Traxter G1 MAX, Traxter G2, Traxter G2 MAX	295101016
	<ul style="list-style-type: none"> • 26 gal (100 L) of watertight storage. • Installs in seconds with tool-less LinQ accessory system. • Dedicated essentials compartment for registration, license, insurance and more. • Exclusive D.E.S.S. key storage. • External quick-access pocket for small items like keys and wallets. 	<ul style="list-style-type: none"> • Turns into a backpack when you get off your machine. • Collapsible if not fully packed with straps on both sides. • Dimensions: 26" L x 18" W x 14" H.

LinQ ACCESSORIES WITH 36" BASE

LinQ Cargo Basket (90 L)	Traxter G2, Traxter G2 MAX	715005274
	<ul style="list-style-type: none"> • Made of polyethylene. • Storage capacity of 23 gal (90 L). • Easy to install and remove with the LinQ system. • 6 handles on the contour to easily install bungee cords. • Ability to install Tool Holders (715008896) to the basket. 	

LinQ 12 Gal (45 L) Cargo Box	Traxter G1, Traxter G1 MAX	715003879
	<ul style="list-style-type: none"> • Holds cargo safely and securely while riding. • LinQ mounted for easy-on, easy-off installation. • See table for installation location and requirements. 	

LinQ 23 Gal (86 L) Trunk Box	Traxter G1, Traxter G1 MAX	715004923
	<ul style="list-style-type: none"> • Lockable and weather-resistant. • Holds cargo safely and securely while riding. • See table for installation location and requirements. 	

LinQ 11.5 Gal (43 L) Audio Cargo Box	Traxter G1, Traxter G1 MAX	715003018
	<ul style="list-style-type: none"> • An affordable and quick solution for adding music and storage to your next ride. • The rear installation does not use up any cab space and allows easy listening at an average speed. • Mounts on/off easily to hold/carry cargo safely and securely. • The Bluetooth enabled receiver and 6.5" (16.5 cm) speakers are smartly concealed and integrated in the cover. • Automatic shut-off function protects your battery by turning the system off after 10 minutes of inactivity. • Backlit control panel perfect for night riding. • Water-resistant speakers. • See table for installation location and requirements. 	

LinQ Cargo Box (53 L)	Traxter G2, Traxter G2 MAX	715006997
	<ul style="list-style-type: none"> • Made of polyethylene. • Storage capacity of 14 gal (53 L). • Easy to install and remove with the LinQ system. • New ergonomic and resistant latch system offers excellent sealing. • Possibility to install LinQ 16" accessories on the cover and increase the cargo capacity. • Ability to install Tool Holders (715008896) on the box. • Lockable with a lock on the front of the box (2 keys included). 	

LinQ 8 Gal (30 L) Cooler Box	Traxter G1, Traxter G1 MAX	715004778 • Black
	<ul style="list-style-type: none"> • Installs without vehicle modification. • Rotomolded construction provides exceptional rigidity and durability. • Premium-quality foam insulation for optimal ice retention. • Integrated, fully removable compartment protects food. • Robust rubber latches keep the cover tightly closed. • Weather-resistant. • Convenient drain plug. • See table for installation location and requirements. 	

LinQ 9.2 Gal (35 L) Cooler

Traxter G2, Traxter G2 MAX

715006998



- LinQ-mounted for efficient and secure storage, locked in place with only a quarter turn.
- Easy to install, easy to remove using the LinQ system.
- Installation in LinQ 36" configuration.
- Made of polyethylene for exceptional rigidity and durability.
- Storage capacity of 9.2 gal (35 L).
- Lock the cooler on the vehicle using the LinQ Lock (860201968).
- Premium-quality foam insulation for optimal ice retention.
- Molded-in handles for quick installation and removal.
- Option to add a 5-slot LinQ Lite Rail on the side and at the rear of the cooler.
- A dry basket is included to protect your food from water.
- Drain plug at the bottom to get rid of excess water.
- The new ergonomic and resistant latch system ensures the top is tightly sealed.
- Innovative way to hold 12 cans (355 ml).
- Cannot be installed on the front rack.

LinQ Premium Storage Bag by OGIO

Traxter G1, Traxter G1 MAX

■ 715002923 • Black



- Tool-less installation and removal thanks to the LinQ system.
- 17.2 gal (65 L) capacity semi-rigid cargo bag ideal for carrying anything you need on your vehicle.
- Buckle and elastic closure with a rubber seal that prevents dust from entering the bag.
- 3-section lid for partial or full access to your bag.
- Inside separators for optimal bag organization.
- See table for installation location and requirements.

LinQ Heavy-Duty Basket

Traxter G1, Traxter G1 MAX

715001215



- Made of high-strength, low-alloy steel.
- See table for installation location and requirements.

LinQ Low Profile Basket

Traxter G1, Traxter G1 MAX

715004282



- Low profile, open basket increases cargo space.
- Perfect for easy access to tools, rope, winch and plow accessories.
- Multiple bungee cord and tie-down anchor points.
- Made of impact-resistant injected polypropylene.
- See table for installation location and requirements.

LinQ CARGO & RACK

NEW LinQ Cargo Bed Box

Traxter G1, Traxter G1 MAX, Traxter G2, Traxter G2 MAX

715009165



- Large 40 gal (150 L) multifunction weather-resistant tool box designed for cargo beds.
- Rotomolded construction provides exceptional rigidity and durability.
- LinQ mounted for easy-on, easy-off installation.
- Features built-in cup holders and integrated groove for pipe or 2x4 cutting.
- Sized to give you the option of installing 2 tool boxes in the cargo bed (the tailgate extension is not compatible with two LinQ Cargo Bed Boxes).
- Double side openings with lockable covers and rubber latches.

LinQ Tailgate Extension

Traxter G1, Traxter G1 MAX (except 6x6 and PRO models)

715002464



- Adds rear cargo capacity when the tailgate is open.
- Steel-tubing-system-style barrier mounts on top of the bed walls using the easy, tool-less LinQ system.
- Can be mounted to serve as cargo divider at different locations along the bed wall while preventing larger items from falling off the back.
- Stores neatly out of the way and offers additional cab area protection since it can be mounted upside down on the front bed wall as a mini headache rack.
- Anti-corrosion coating with durable powder coat finish.
- Not compatible with hard rear windows on Traxter MAX produced before January 2021.

LinQ Tire Holder

Traxter G1, G2 (except 6x6 & PRO models), Traxter G1 MAX, Traxter G2 MAX

715003448



- Cargo box spare-tire holder.
- Heavy-duty steel construction.
- Inside and outside anti-corrosion coating with durable powder coat finish.
- Mounts on top of the bed walls using the easy, tool-less LinQ system.
- Compatible with Bed Wall Extender.
- Uses BRP standard wheel bolt pattern to mount tire (nuts included).
- Accommodates BRP tires up to 28" (wheel not included).
- Quickly allows installation in multiple positions thanks to the LinQ system.
- Not compatible with cargo bed winch.

LinQ Cargo Rack

Traxter G1, Traxter G1 MAX

715006140



- Strong, durable steel rack.
- Easy and tool-less installation thanks to the LinQ system.
- Allows the installation of LinQ accessories.
- 2 racks can be installed at the same time.
- Allows multi-level storage on cargo bed, accommodates 5 gal (19 L) bucket.
- Helps keep cargo securely in place.
- Multiple bungee cord and tie-down anchor points.
- Kit includes LinQ Base.
- Provides more usable space in the cargo box.

LinQ Front Rack

Traxter G1, Traxter G1 MAX

715006064



- Rugged looking front rack mounts on top of vehicle hood and provides additional storage.
- Heavy-duty 1.25" (3.2 cm) diameter steel-tube construction.
- Inside and outside anti-corrosion coating with durable powder coat finish.
- Flip-up configuration provides easy access to service area.
- Allows the installation of LinQ accessories (especially for use with LinQ Low Profile Basket (715004282)).
- Kit includes LinQ Base.
- Multiple bungee cord and tie-down anchor points.
- Requires Rancher Bumper (715005410) or Front Bumper (715002418 or 715005754) for installation.
- A great place to store tools while working in the field.

LinQ HOLDERS

NEW LinQ Lite Device Holder

Traxter G2, Traxter G2 MAX

715009201



- Made with strong magnets that you can trust while riding through rough terrain
- Includes everything needed for installation on your favorite electronic devices: 2 pre-assembled Can-Am plates with 3M multi-surface adhesive.
- 360° adjustment for an improved driving experience and immersion.
- Secure LinQ Lite attachment allows you to install/remove the holder in seconds.
- Robust plastic and aluminum construction allows for the right fit and easy installation.
- Compatible with the Cellphone Holder (715008786).
- Holds most tablets and smartphones measuring between 5.1" (13 cm) and 10" (25.4 cm) (with protective case).

NEW LinQ Lite Action Camera Holder

Traxter G2, Traxter G2 MAX

295101139



- LinQ Lite attachment system for cameras.
- Provides great vantage points to capture photos and videos.
- Offers 360-angle positioning for perfect filming and taking photos.
- Designed to hold devices securely.
- Fast, easy attachment and removal.

LinQ Lite Cup

Traxter G2, Traxter G2 MAX

715007804



- Keep your beverage within reach.
- Flexible fins adjust to various beverage container sizes to hold most securely.
- No permanent installation point means you're free to move it almost anywhere.
- Tool-less placement, easy to move from place to place.

LinQ Tool Holder

Traxter G1, Traxter G1 MAX, Traxter G2, Traxter G2 MAX

715007358



- Ultra-versatile tool holder.
- Convenient swivel-latch allows tools to be stored in any orientation.
- Suitable for installation onto the cargo walls, Deluxe Headache Rack, Bed Wall Extender, Adventure Roof Rack and LinQ Loadout Rack.
- If mounted on the Deluxe Headache Rack or the Bed Wall Extender, LinQ Adapter is required for installation.
- Sold in pairs.

LinQ Gear Grips

Traxter G1, Traxter G1 MAX, Traxter G2, Traxter G2 MAX

715005340



- Durable and flexible grips provide a custom fit for a variety of items from 1" to 4" (2.5 cm to 10 cm) in diameter.
- Heavy-duty design for carrying bows, fishing poles, rakes, farm tools and more.
- Quick-release button opens grip quickly for easy access to gear.
- Heavy-duty base system built for the toughest adventures.
- Make transporting your tools a snap by combining the Gear Grips with the LinQ system.
- 360° orientation.
- Sold in pairs.

LinQ MOUNTING

LinQ Adapter	Traxter G1, Traxter G1 MAX	715003058
---------------------	----------------------------	------------------



- Allows the installation of the LinQ Tool Holder to the Bed Wall Extender, Adventure Roof Rack or the Deluxe Headache Rack.
- Sold in pack of 4.

LinQ Lock	Traxter G1, Traxter G1 MAX, Traxter G2, Traxter G2 MAX	860201968
------------------	--	------------------



- Simple way to securely lock most LinQ accessories.
- Lock cover protects lock from the elements.
- Corrosion resistant.
- Pack of 1, includes 2 keys.
- Not compatible with LinQ 4,2 US gal (16 L) Cooler, LinQ Tool Box, LinQ Tool Holder or LinQ Gear Grips.

LinQ Base Installation Kit	Traxter G1, Traxter G1 MAX, Traxter G2, Traxter G2 MAX	715008125
-----------------------------------	--	------------------



- Unique mounting fastener usable on any LinQ system accessory.
- Included: 2 LinQ Cargo Bases and hardware.

LinQ Replacement Part	Traxter G1, Traxter G1 MAX, Traxter G2, Traxter G2 MAX	715010798
------------------------------	--	------------------



- Unique mounting fastener usable on any LinQ system accessory.
- Tool-less installation and removal.
- Sold in pairs.

CARGO & STORAGE

NEW Cargo Rack Multi-position	Traxter G2	715009148
--------------------------------------	------------	------------------



- Built with heavy-duty stamped steel sheet metal with powder-coated finish.
- Loads of up to 70 lb (32 kg).
- 31" (79 cm) x 53" (135 cm) cargo basket area.
- 2 LinQ anchors on each outer side for LinQ Tool Holder (715007358).
- Many LinQ anchors can be installed at the bottom of the cargo tray to mount various LinQ accessories, 7 different positions available for LinQ 16" and 2 for LinQ 36".
- Integrated mounting points in the front for LED Light Bars (715008745 or 715008747).
- Multiple tie-down points on the sides so you can tie your gear.
- Fits on the roof with no additional requirements other than having a Sport Roof.
- Can also be installed over the cargo bed wall with the Cargo Rack Mounting Kit (715010079) or on the bed wall extenders with the Cargo Rack Mounting Kit (715010078).
- Not compatible with MAX models or Audio Roof.

NEW Cargo Rack MAX	Traxter G2 MAX	715009170
---------------------------	----------------	------------------



- Built with heavy-duty stamped steel sheet metal with powder-coated finish.
- Loads of up to 70 lb (32 kg).
- 61" x 53" cargo basket area.
- 4 LinQ anchors on each outer side for LinQ Tool Holder (715007358).
- Many LinQ anchors can be installed at the bottom of the cargo tray to mount various LinQ accessories, 14 different positions available for LinQ 16" and 4 for LinQ 36".
- Integrated mounting points in the front for LED Light Bars (715008745 or 715008747).
- Multiple tie down points on the sides so you can tie your gear.
- Roof mounted only.
- Installation of the Sport Roof is required.
- Not compatible with Audio Roof.

NEW Cargo Rack Mounting Kit for Bed Wall Extender

Traxter G2, Traxter G2 MAX

715010078



- Allows installation of the Cargo Rack Multi-Position (715009148) on the Low or High Bed Wall (715009590, 715010833 or 715009166).

NEW LinQ Cargo Rack Mounting Kit for Cargo Bed

Traxter G2, Traxter G2 MAX

715010079



- Allows installation of the Cargo Rack Multi-Position (715009148) on the cargo bed.
- Allows a clearance of 15" (40 cm).
- LinQ system for a fast install and removal.

NEW Foldable Tailgate Extension

Traxter G2, Traxter G2 MAX

715009179



- Foldable tailgate extension that stores on the vehicle and is always there when needed.
- Effortless installation using the tailgate striker bolts. Just unfold each side and hook them in.
- Can be quickly and completely removed from the vehicle without any tools.
- Rotomolded plastic construction for rugged durability.
- Adds rear cargo capacity when the tailgate is open.

Loadout Rack

Traxter G1, Traxter G1 MAX

715005447



- LinQ installed versatile rack that creates a second level of storage.
- Adjustable height that goes from mid cab height to roof line.
- Modular basket adapts to different cargo with folding front and rear panels.
- Multiple hooks and holes to hang items both inside and outside the rack.
- Basket accommodates multiple LinQ positions.
- Combine with cargo net to create a hanging storage net below the basket for additional space.
- 2 racks can be installed on Traxter Pro and Traxter 6x6.

Hanging Storage Box Kit

Traxter G1, Traxter G1 MAX

715005449



- Versatile rack designed to hold a standard storage box.
- Fully adjustable, the rack can be tailored to hold the crates in multiple positions: headache rack position, inside the box along the side wall, and outside the box along the side wall.
- Includes Can-Am branded storage box.
- Exterior Cargo Reinforcement Panel is recommended when used outside of bed wall.

Can-Am Storage Box

(Not illustrated)

Traxter G1, Traxter G1 MAX

708303237

- Conventional 13" x 13" plastic storage box with Can-Am branding.
- Perforated bottom allows water and debris to escape.

Exterior Cargo Reinforcement Panel

(Not illustrated)

Traxter G1, Traxter G1 MAX

715006198

- Plate that attaches to the bed side to further support and protect bed wall when in outward position.
- Recommended use of the hanging storage box and/or gun and tool holder when installed outside of the bed wall (except Traxter 6x6 & PRO).

NEW Headache Rack

Traxter G2, Traxter G2 MAX (except X mr models)

715009171



- Protects cab components from cargo load.
- 4 LinQ anchors integrated to the frame.
- Forged steel corner where you can add tie-down to secure your material.
- Complete with wire screen design.
- Compatible with LinQ Gun Case (715009240).
- Increases box capacity when used in tandem with the Bed Wall Extender (715009590 & 715009166).
- Required to install the Bed Wall Extender - High (715009590).
- Not compatible with Snorkel Kit (715009151).

Deluxe Headache Rack	Traxter G1, Traxter G1 MAX	715002423
-----------------------------	----------------------------	------------------



- Protects cab components from cargo load.
- Increases box capacity when used in tandem with the Bed Wall Extender (715002421).
- Required to install the Bed Wall Extender (715002421).
- Compatible with gear rail.

NEW Bed Wall Extender – Low	Traxter G2, Traxter G2 MAX	715009166
------------------------------------	----------------------------	------------------



- Extend your cargo box by 16" (422 mm) with this Bed Wall Extender.
- Allows the installation of the Cargo Rack Multi-position over the bed to create a second level of storage.
- 1.25" (3.2 cm) diameter steel-tube construction.
- Inside and outside anti-corrosion coating with durable powder coat finish.
- Forged steel corner where you can add tie-downs to secure your material.
- Outer panels in robust glass-filled plastic with LinQ Nano anchors.
- 2 LinQ anchors at the ends of each panel for installing LinQ Tool Holders (715007358).
- Each upper end is equipped with a ruler to facilitate measurement.
- Quick and simple installation.
- Not compatible with Cargo Bed Winch (715009419) or Snorkel Kit (715009151).

NEW Bed Wall Extender – High	Traxter G2, Traxter G2 MAX	715010833
-------------------------------------	----------------------------	------------------



- Extend your cargo box by 29" (755 mm) with this Bed Wall Extender.
- Allows the installation of the Cargo Rack Multi-position over the bed to create a second level of storage.
- 1.25" (3.2 cm) diameter steel-tube construction.
- Inside and outside anti-corrosion coating with durable powder coat finish.
- Forged steel corner where you can add tie-downs to secure your material.
- Outer panels in robust glass-filled plastic with LinQ Nano anchors.
- 2 LinQ anchors at the ends of each panel for installing LinQ Tool Holders (715007358).
- Each upper end is equipped with a ruler to facilitate measurement.
- Quick and simple installation.
- Not compatible with Cargo Bed Winch (715009419) or Snorkel Kit (715009151).

NEW Bed Wall Extender – High (for Headache Rack)	Traxter G2, Traxter G2 MAX	715009590
---	----------------------------	------------------



- Extend your cargo box by 29" (755 mm) with this Bed Wall Extender.
- Allows the installation of the Cargo Rack Multi-position over the bed to create a second level of storage.
- 1.25" (3.2 cm) diameter steel-tube construction.
- Inside and outside anti-corrosion coating with durable powder coat finish.
- Forged steel corner where you can add tie-downs to secure your material.
- Outer panels in robust glass-filled plastic with LinQ Nano anchors.
- 2 LinQ anchors at the ends of each panel for installing LinQ Tool Holders (715007358).
- Each upper end is equipped with a ruler to facilitate measurement.
- Quick and simple installation.
- Requires Headache Rack (715009171).
- The Bed Wall Extender (715010833) can be installed without the Headache Rack.
- Not compatible with Cargo Bed Winch (715009419) or Snorkel Kit (715009151).

Bed Wall Extender	Traxter G1, Traxter G1 MAX (except G1 6x6 & G1 PRO)	715002421
	Traxter G1 6x6 & PRO models	715005411



- Increases box capacity.
- Quick and easy tool-less modularity.
- Easily removable rear door can be latched open.
- Variable full or half height settings.
- Foldable top panels come off in seconds.
- Requires Deluxe Headache Rack (715002423).

Tonneau Cover	Traxter G1 2018 & up (except Mossy Oak Break-Up Country Camo models), Traxter G1 MAX (except 6x6 and PRO models)	715008306
----------------------	--	------------------



- Fitted to cover all of the items in your cargo box thoroughly.
- Prevents splash from entering the cargo box.
- Rolls up to the front.
- Easily removable for quick access.
- Not compatible with accessories that exceed the box height.

Removable Storage Bin

Traxter G1, Traxter G1 MAX

715004344

- Handy, removable on-dash tool box will make sure you have your critical equipment where you need it.
- Provides 1.7 gal (6,3 L) of storage and clips on and off in a snap.
- Water-resistant to ensure your contents remain safe and dry.

Removable Storage Bin – Passenger

Traxter G1, Traxter G1 MAX, Traxter G2, Traxter G2 MAX

715003314

- Convenient passenger-side underseat storage.
- Polypropylene-injected 3.7 gal (14 L) storage capacity bin.
- Bin installs and removes in a snap and comes with an integrated handle.
- Water-resistant.

Driver Underseat Storage Bin

Traxter G1, Traxter G1 MAX

715003399

- Polypropylene-injected 4 gal (15 L) capacity bin fits securely under the driver's seat.
- Front opening for quick and easy access.
- Ideal for storing weather-resistant items, such as ropes, tow straps and winch accessories that are needed at a moment's notice.

NEW Center Underseat Storage Bin (7 L)

Traxter G2, Traxter G2 MAX

715009199

- Polypropylene-injected 1.8 US Gal (7 L) capacity storage bin.
- Watertight design keeps ice and drinks cold.
- Easy to remove and wash thanks to its integrated handle.
- Designed to receive a second battery when used with the Auxiliary Battery Installation Kit (715009473).
- Integrated drain plug allows easy draining.
- Accessible by lifting center seat section.

Center Underseat Storage Bin

Traxter G1, Traxter G1 MAX

715003446

- Polypropylene-injected 2 gal (8 L) capacity storage bin.
- Watertight design keeps ice and drinks cold.
- Easy to drain and wash by removing it with integrated handle.
- Accessible by lifting center seat section.

Cargo Bed Rails

Traxter G1 (except 6x6 & PRO), G1 MAX

715003444

- Add integrated tie-down area to your cargo box while enhancing the look.
- Added cargo box protection.
- Inside and outside anti-corrosion coating with durable powder coat finish.
- Heavy-duty 1" (2,5 cm) diameter steel-tube construction.
- Add height to the bed side wall and serve as a tie-down anchor for ropes, straps or bungees.
- Not compatible with Bed Wall Extender.
- Sold in pairs.

Cargo Bed Net

Traxter G1 (except 6x6 & PRO), Traxter G1 MAX, Traxter G2, Traxter G2 MAX

715003445

- Solid net designed to hook to the bottom of the cargo box for secure and compact confinement of your cargo.
- Keeps items tightly against the bed floor.

Dash Storage Compartment Net for Heating System

Traxter G1, Traxter G1 MAX (XU models only)

715003544

- Perfect for securing items in the dash storage area.
- To be installed when Lower Dashboard for Heating System is installed.

Lower Dashboard for Heating System	Traxter G1, G1 MAX (XU models only)	715003441
---	-------------------------------------	------------------



- Replaces the dashboard that comes stock with the vehicle and features a tablet that makes it possible for driver and passenger to conveniently store small items in the dash.
- To be installed when the Defrost, Heat & Ventilation System is installed.
- Use together with the Dash Storage Compartment Net for Heating System (715003544) to prevent the items placed in the dash storage compartment from falling.

Dash Storage Compartment Nets	Traxter G1, Traxter G1 MAX (except Limited models)	715003129
--------------------------------------	--	------------------



- Perfect for securing items in the dash storage area.
- Not compatible with Defrost, Heat & Ventilation System.
- Sold in pairs.

Backrest Rear Storage	Traxter G1 MAX, Traxter G2 MAX	715003019
------------------------------	--------------------------------	------------------



- Netting installs easily.
- Made from polyester that won't discolor.
- Sold in pairs.

Storage 2.6 Gal (10 L) Bag	Traxter G1, Traxter G1 MAX, Traxter G2, Traxter G2 MAX	269502121
-----------------------------------	--	------------------



- Roll-top dry bag for fully protecting your cargo from the elements.

Passenger Storage Seat Bag	Traxter G1, Traxter G1 MAX, Traxter G2, Traxter G2 MAX	715008080
-----------------------------------	--	------------------



- This weather-resistant bag holds your gear safely and securely while you ride.
- Bag settling on the passenger's seat to increase the vehicle's cargo capacity.
- This bag features a 14.5 gal (55 L) storage capacity and is divided into two compartments.
- The top compartment is insulated to keep your beverages cold and includes two cup holders.
- Additional pocket inside for additional storage, such as a cell phone.
- The bottom compartment is accessible from both sides and serves as a large pocket for storing various items.
- The detachable pocket at the front of the bag can be used as a garbage bag.

RACKS & HOLDERS

Rear Accessory Bar	Traxter G1, Traxter G1 MAX	715005450
---------------------------	----------------------------	------------------



- Strong accessory bar allowing installation or hanging items off the back.
- Holes for carabiners, duck decoy hangers or other items.
- LinQ anchors allow installation of many LinQ accessories.

Adventure Roof Rack	Traxter G1 Loads of up to 71 lb (32 kg).	715003870
	Traxter G1 MAX Loads of up to 71 lb (32 kg).	715004391



- Ideal cargo solution for packing everything you need to live your off-road experience fully and completely.
- Built with heavy-duty 1.25" (3.2 cm) diameter steel tubing.
- Modular LinQ support plates allow for installation of most LinQ cargo accessories.
- Integrated mounting points for lights can hold up to 8 pod-type LED lights (6 front and 2 back) or a 39" (99 cm) LED bar (front)—see table for compatibility.
- Features anchor points for spare tire attachment.
- Spare Tire Tie-Downs sold separately.
- Add the Cargo Box Net or the Cargo Box Elastic Net to secure and confine your cargo in the rack.
- Not compatible with Bimini Roof or Audio Roof.

Spare Tire Ratchet Tie-Downs

Traxter G1, Traxter G1 MAX

28000955

- 3-way ratcheting tie-down strap with loop ends.
- Designed to securely hold spare tires on accessories equipped with integrated spare tire attachment points.
- Adjustable to accommodate most common UTV tire sizes.
- Ratchet and junction ring made of durable zinc-plated steel.
- Required for spare tire attachment on Adventure Roof Rack.

LinQ Tool & Gun Holder

Traxter G1, Traxter G1 MAX, Traxter G2, Traxter G2 MAX

715005466

- 2-in-1 holding rack can be used both on the job or on the hunt.
- Includes 5 locations to securely hold tools and guns using rubber grips and retention straps at the top and a rubber mat with gunstock shaped molding at the bottom.
- Easy to remove, install or reposition using our simple and secure LinQ system.
- Can be attached at multiple positions along the cargo bed walls, facing inside or outside the bed.
- Recommended to use with the Exterior Cargo Reinforcement Panel (715006198) when installed outside the bed wall.

LinQ Gun Case

Traxter G1, Traxter G1 MAX, Traxter G2, Traxter G2 MAX

715009240

- Practical design allows you to store shotguns and rifles up to 52" (132 cm) even with most optic configurations.
- Adapts to different weapon shapes and features with foam cushions that can be repositioned.
- LinQ-mounted for efficient and secure storage, locked in place with only a quarter turn.
- LinQ Gun Case Mounting Kit (715006443) is required for installation.

LinQ Gun Case Mounting Kit

Traxter G1, Traxter G1 MAX, Traxter G2, Traxter G2 MAX

715006443

- Required to install the LinQ Gun Case on a Traxter and Traxter MAX.
- Allows you to install up to two LinQ gun cases.
- Includes one pair.

Gun Boot 6.0[†] Impact by Kolpin[†]

Traxter G1, Traxter G1 MAX

715001419

- Extra room for pistol-grip-type weapons and small bipods.
- Easily fits firearms up to 51" (1.3 m) in total length.
- Provides ample room for 2.4" (60 mm) scopes.
- Hatchback design allows easy access.
- Snap-close cover with locking capability.
- Ergonomically designed handle and molded attachment points for sling.
- Designed to accommodate left- and right-hand bolt-action rifles and shotguns.
- Requires Gear Rail and Gun Boot Mount by Kolpin for installation.
- Includes removable, shock-absorbing foam and nylon Impact liner for superior interior protection.
- Compatible for dual mount with additional Gun Boot Mount.

Gun Boot Mount by Kolpin

Traxter G1, Traxter G1 MAX

715001420







- Fits one Kolpin Gun Boot 6.0 Impact.
- Lightweight and extremely durable.
- Easily adjustable without the use of any tools.
- Offers precision gun angle adjustability.
- Requires Gear Rail for installation.

Dual Gun Holder

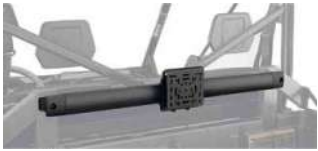
Traxter G1, Traxter G1 MAX

715005265

- Accommodates shotguns, rifles or muzzleloaders.
- Mounts in the cab, on floor board between driver and passenger.
- Rubber pads provide gun protection.
- Can be removed to allow a center passenger.
- Anti-corrosion coating with durable powder coat finish.
- Comes with all hardware for easy installation.
- Keeps your weapons within easy reach and protected within the cab area.
- Refer to your local regulations governing the transportation of firearms before purchase.

Gear Rail	Traxter G1, Traxter G1 MAX (except X mr models)	715003391
	<ul style="list-style-type: none"> • Stationary rail system specially designed for your side-by-side vehicle. • Universal mounting options for many Kolpin accessories like Gear Grips and Universal Saw Press. • Rail is made with heavy-duty 7-gauge extruded anodized black aluminum. • Mounts on roll bar. • Includes one versatile Gear Rail Mount by Kolpin. • Requires Deluxe Headache Rack (715002423) or Gear Rail Adapter (715003392). 	
Gear Rail Adapter	Traxter G1, Traxter G1 MAX (except X mr models)	715003392
	<ul style="list-style-type: none"> • Allows the installation of gear rails directly onto the cargo box without the need for a headache rack. 	
Gear Rail Mount by Kolpin	Traxter G1, Traxter G1 MAX	715001422
	<ul style="list-style-type: none"> • Accessory bracket for mounting additional accessories to the Gear Rail. • Includes C-clamp and metal mounting brackets. 	
Double Gun Bag	Traxter G1 (except XT Cab, X mr models), Traxter G1 MAX (except XT Cab and Limited package)	■ 715003133 • Black
	<ul style="list-style-type: none"> • Shell constructed with heavy-duty, weather-resistant polyester to shelter guns from dust and other outdoor elements, while the thick interior padding protects the guns from shocks. • Fits perfectly on rear cage and guns are readily accessible from both sides of vehicle. • Design features include a removable center pocket that can be mounted on both sides of the bag and extra front storage pockets for hunting gear. • Solid, quick installation. • Not compatible with rear wind protection, headache racks and gear rails. • May interfere with the tilt function of the Traxter 6x6 or Traxter PRO models' beds. 	
Universal Saw Press by Kolpin	Traxter G1, Traxter G1 MAX (except X mr models)	715001423
	<ul style="list-style-type: none"> • Specially crafted for transporting your chainsaw securely and safely aboard your side-by-side vehicle. • Heavy-duty, black powder-coated metal bracket designed to attach any chainsaw model with up to a 20" (51 cm) bar. • Rubber pads provide cushion and tight fit. • Hinged design for quick removal. • Holds saw in vertical position or 45° angle in either direction. • Requires Gear Rail. • Protective sheath included. 	
LinQ Gear Grips	Traxter G1, Traxter G1 MAX, Traxter G2, Traxter G2 MAX	715001421
	<ul style="list-style-type: none"> • Durable, flexible grips cushion and protect while providing a custom fit for a variety of items from 1" to 4" (2.5 cm to 10 cm) in diameter. • Heavy-duty design for carrying bows, fishing poles, rakes, farm tools and more. • Quick-release button opens grip quickly for easy access to gear. • Heavy-duty base system built for the toughest adventures. • Easy installation on tubular racks, extension racks, brackets or bumpers. • Sold in pairs. 	



SMART ACCESSORIES

Powered by the ACM, SMART Accessories respond automatically to speed, steering, and other sensor data, adjusting light output, behavior, and function in real time.

A RESPONSE SYSTEM THAT TAKES TECH TO THE NEXT LEVEL.

ACM

This is the brain of the SMART Ecosystem. It reads multiple sensors on the vehicle and translates the reading into actions for the accessories.

SMART CONTROL CENTER

Allows you to quickly access SMART Accessories (can be used with or without the 10.25" touchscreen display).

SMART ACCESSORIES

Accessories designed to execute multiple functions depending on the input from the ACM.



ACM & SMART ACCESSORIES

NEW Accessory Control Module	Traxter G2, Traxter G2 MAX	715009121
-------------------------------------	----------------------------	------------------



- Bringing the SMART innovation to accessories using live vehicle ECU information to maximize your accessory experience.
- Connect your accessories to the 10.25" Color Touchscreen Display (if equipped).
- Easy accessory installation (plug and play).
- Creates an ecosystem that makes installing accessories quicker and easier.
- Includes ACM Front Harness and Roof Harness to connect front-mounted SMART accessories to the Accessory Control Module (five auxiliary connectors available).
- Accessory Control Center (715010834) required for models without the 10.25" Color Touchscreen Display.

NEW SMART Control Center for ACM	Traxter G2, Traxter G2 MAX	715010834
---	----------------------------	------------------



- Control the accessories with the selection of different modes, the illuminated halo around the button indicates the active mode.
- Icons illuminate when accessories are activated.
- Make accessory control changes without having to take your eyes off the trail by choosing the accessory button required (quick access).
- All Front LED Off button to turn off all front lights with one click. Remembers the last programmed setups when this button is pressed again.
- 6 pre-programmed buttons and 10 programmable buttons to customize according to the accessories installed.

NEW SMART 10" (25 cm) LED Light Bar	Traxter G1, Traxter G1 MAX, Traxter G2, Traxter G2 MAX	715008745
--	--	------------------



- The perfect combination of powerful white and selective yellow LEDs.
- The selective yellow LEDs are ideal for driving in low visibility conditions.
- The light is composed of 16 white LEDs and 8 yellow LEDs.
- Spot and Flood combo beam.
- The side lens design provides highly effective wide-angle illumination.
- The white LEDs produce 8,100 raw lumens and the selective yellow 2,640 raw lumens, delivering stunning lighting performance.
- The lens is made from hard-coated polycarbonate.
- IP67 and IP69k submersible and pressure washer safe.
- Switch options: Off, Low and High. Color change by flicking the switch quickly.
- SMART options: Off, Low, High, color change and SMART Automatic Mode.
- SMART MODE: Intensity increases or decreases and Spot/Flood ratio varies according to the speed of the vehicle with the installation of the Accessory Control Module (ACM).
- Accessory Control Module (715009121) is required for SMART functionality.
- Lights Wiring Harness (715009886) is required for on/off function when ACM is not installed. Sold separately.
- Just a heads-up, you'll need a bumper for this.
- ECE Certified

NEW SMART 40" (102 cm) LED Light Bar	Traxter G2, Traxter G2 MAX	715008747
---	----------------------------	------------------



- The perfect combination of powerful white or selective yellow LEDs.
- The selective yellow LEDs are ideal for driving in low visibility conditions.
- The light is composed of 64 white LEDs and 32 yellow LEDs.
- Spot and Flood combo beam.
- The side lens design provides highly effective wide-angle illumination.
- The white LEDs produce 32,000 raw lumens and the selective yellow 10,560 raw lumens, delivering stunning lighting performance.
- The lens is made from hard-coated polycarbonate.
- IP67 and IP69k submersible and pressure washer safe.
- Switch options: Off, Low and High. Color change by flicking the switch quickly.
- SMART options: Off, Low, High, color change and SMART Automatic Mode.
- SMART MODE: Intensity increases or decreases and Spot/Flood ratio varies according to the speed of the vehicle with the installation of the Accessory Control Module (ACM).
- Accessory Control Module (715009121) is required for SMART functionality.
- Wiring Harness (715009930) is required for on/off function when ACM is not installed. Sold separately.
- Requires LED Light Bar Mounts (715009261) or mounts directly to some Can-Am audio roofs.
- See table for installation location and requirements.
- ECE Certified

NEW SMART LED Hood Light	Traxter G2, Traxter G2 MAX	715009299
---------------------------------	----------------------------	------------------



- Mounted seamlessly on the hood, it doesn't require a bumper or brackets.
- Both ends feature angled LEDs for a wider light spread.
- Integrated signature light enhances your vehicle look and makes it instantly recognizable.
- Good option for X mr models where the bumper mounting plate is used for the winch or any other models with a relocated winch.
- Mounted higher up so less likely to be blocked by another accessory.
- 10,500 raw lumens for exceptional brightness.
- The lens is made from hard-coated polycarbonate.
- IP67 and IP69k submersible and pressure washer safe.
- Switch options: Off, Low and High.
- SMART options: Off, Low, High and SMART Automatic Mode.
- SMART MODE: It's got a unique startup light sequence that adds a touch of style every time you power up your vehicle. Intensity increases or decreases and Spot/Flood ratio varies according to the speed of the vehicle with the installation of the Accessory Control Module (ACM).
- Accessory Control Module (715009121) is required for SMART functionality.
- Lights Wiring Harness (715009886) is required when ACM is not installed. Sold separately.
- ECE Certified

NEW SMART Intermittent Wiper & Washer Kit

Traxter G2, Traxter G2 MAX

715009441



- An ideal way to keep your windshield clear in rain, or while riding through mud and water.
- Includes single-speed wiper, washer fluid dispenser and windshield frame mount.
- Automatic speed variation mode and intermittent wiper speed features available when the kit is installed in combination with ACM and that varies with vehicle speed.
- Must be used with the Glass Windshield (715010876) or Flip Glass Windshield (715009225).
- Requires Wiper and Power Cables when ACM is not installed:
 - If equipped with the Sport Roof, Power Cables (715010489 & 715009756) are required.
 - If equipped with the Audio Roof, Power Cables (715010324) is required.
- Included with Flip Glass Windshield with SMART Intermittent Wiper & Washer Kit (715009890).

Installation of some accessories shown may impact vehicle compliance with some regulations. Consult your local dealer for information.



LIGHTS

CAN-AM LIGHTS — TRAXTER G1

1 CHOOSE YOUR MOUNT POINT	2 FIND YOUR PLATFORM	3 CHOOSE YOUR LIGHTS					
		10" (25 cm) Double Stacked LED Bar 715002933	15" (38 cm) Double Stacked LED Bar 715002934	SMART 10" (25 cm) LED Light Bar 715008745	39" (99 cm) Double Stacked LED Bar 715004007	4" (10 cm) Round LED LIGHTS (sold in pairs) 715002935	3.5" (9 cm) LED Lights (sold in pairs) 715010093 & 715010094
Front Bumper Rancher Bumper XT Front Bumper X mr Front Bumper (w/o winch) X-TP Front Bumper	Traxter Traxter MAX 2019 & prior	715002454 (Light Power Cable)	715002454 (Light Power Cable)	715009886 (Lights Wiring Harness)	No compatibility	715002454 (Light Power Cable) (1 harness can support 2 lights)	
	Traxter Traxter MAX 2020 & up	715006034 (Light Power Cable)	715006034 (Light Power Cable)	715009886 (Lights Wiring Harness)		715006034 (Light Power Cable) (1 harness can support lights)	
Light Rack or Light Bars *Roof Power Cable and Front Roof Liner may not be required if already installed with other accessories	Traxter & Traxter MAX (except XT CAB)	715002456 (Light Rack) + 715003094 (Roof Power Cable) + 715008226 (Front Roof Liner)	715002456 (Light Rack) + 715003094 (Roof Power Cable) + 715008226 (Front Roof Liner)	715002456 (Light Rack) + 715003094 (Roof Power Cable) + 715008226 (Front Roof Liner) + 715009886 (Lights Wiring Harness)	715006226 (Light Bar Support) + 715005822 (Power Cable) + 715008226 (Front Roof Liner)	715009301 (Spotlight Support Bar) (only for 3.5" lights) + 715003094 (Roof Power Cable) + 715008226 (Front Roof Liner)	
	Traxter Traxter MAX XT CAB Limited	No requirements	No requirements	No compatibility	715006226 (Light Bar Support) + 715005822 (Power Cable)	No requirements	
Adventure Roof Rack *Roof Power Cable may not be required if already installed with other accessories.	Traxter & Traxter MAX (except XT CAB Limited)	N/A	Front only: 715003417 (Power Cable) + 715003094 (Roof Power Cable) + 715008226 (Front Roof Liner)	N/A	Front only: 715005822 (Power Cable) + 715003094 (Roof Power Cable) + 715008226 (Front Roof Liner)	Front or Rear: 715002935 (4" Round), or 715010093 (3.5" Flood) or 715010094 (3.5" Spot) + 715003417 (Power Cable) & 715003094 (Roof Power Cable) & 715008226 (Front Roof Liner)	
	Traxter, Traxter MAX XT CAB Limited		Front only: 715003417 (Power Cable)		Front only: 715005822 (Power Cable)	Front or Rear: 715003417 (Power Cable)	

4 ORDER **ORDER ALL PART NUMBERS IN INTERSECTING BOX**
 *Note: When installing more than one light kit, additional light power cable or mounting kit is required.

CAN-AM LIGHTS – TRAXTER G2

CAN-AM LIGHTS WITH ACM

		2 CHOOSE YOUR LIGHTS				
1 CHOOSE YOUR MOUNT POINT		SMART 40" (102 cm) LED Light Bar 715008747	SMART 10" (25 cm) LED Light Bar 715008745	SMART LED Hood Light 715009299	3.5" (9 cm) LED Flood Lights (2 X 14 W) 715010093	3.5" (9 cm) LED Driving Lights (2 X 14 W) 715010094
SMART FUNCTIONALITY	Vehicle Integrated	No compatibility	No compatibility	Accessory Control Module 715009121	No compatibility	No compatibility
	Audio Roof 715009224/ 715009223	Accessory Control Module 715009121		No compatibility		
	LED Light Bar Mounts 715009261	No compatibility	No compatibility			
	Spotlight Support Bar 715009301	No compatibility		Accessory Control Module 715009121	Accessory Control Module 715009121 + Round Lights ACM Wiring Harness 715009855 (1 harness can support 4 lights)	
	Cargo Rack Multi-position 715009148/ 715009170	Accessory Control Module 715009121	Accessory Control Module 715009121			
	Large Heavy-Duty Front Bumper 715009164	No compatibility				

CAN-AM LIGHTS WITHOUT ACM

		2 CHOOSE YOUR LIGHTS				
1 CHOOSE YOUR MOUNT POINT		SMART 40" (102 cm) LED Light Bar 715008747	SMART 10" (25 cm) LED Light Bar 715008745	SMART LED Hood Light 715009299	3.5" (9 cm) LED Flood Lights (2 X 14 W) 715010093	3.5" (9 cm) LED Driving Lights (2 X 14 W) 715010094
ON/OFF FUNCTIONALITY	Vehicle Integrated	No compatibility	No compatibility	Lights Wiring Harness 715009886	No compatibility	No compatibility
	Audio Roof 715009224/ 715009223	SMART 40" (102 cm) LED Light Bar Harness 715009930**	No compatibility	No compatibility		
	LED Light Bar Mounts 715009261				Lights Wiring Harness 715009886	
	Spotlight Support Bar 715009301	No compatibility	Light Kit Power Cable 715006034 (1 harness can support 2 lights)			
	Cargo Rack Multi-position 715009148/ 715009170	SMART 40" (102 cm) LED Light Bar Harness 715009930		Lights Wiring Harness 715009886		
	Large Heavy-Duty Front Bumper 715009164	No compatibility				

3 ORDER **ORDER ALL PART NUMBERS IN INTERSECTING BOX**
 *Note: When installing more than one light kit, additional light power cable or mounting kit is required.

**Requires Front Roof Liner (715009196) for installation.

NEW Cable Cover and Roof Power Cable Kit

Traxter G2, Traxter G2 MAX (models without Cab)

715010489



- Designed to organize cables and provide a safe environment by covering exposed cables.
- Required for installation of some electrical accessories.
- Brings power from the battery.
- Cable cover is made from injected plastic.
- Roof power cable included.
- Combined with the Front Roof Liner (715009196) for optimum integration.

Roof Power Cable
(Not illustrated)

Traxter G1, Traxter G1 MAX

715003094

- Required for installation of some electrical accessories.
- Brings power from the battery.

Light Kit Power Cable
(Not illustrated)

Traxter G1, Traxter G1 MAX (2019 & prior)
Traxter G1, Traxter G1 MAX (2020 & up),
Traxter G2, Traxter G2 MAX

715002454
715006034

- Power cable for installation of compatible Can-Am light kits at front bumper location.

NEW Rear LED Light

Traxter G1, Traxter G1 MAX, Traxter G2,
Traxter G2 MAX

715008236



- This high performance LED light provides full illumination for your cargo box and the surrounding area.
- Convenient front liner switch with 2 modes, High & Low.
- High beam mode illuminates up to 50 ft. (15 m) at the rear of the vehicle. Perfect for those moments when you're reversing.
- Low beam mode illuminates your cargo area to ensure easy loading without the harsh glare.
- Sport Roof, Deluxe Sport Roof, Sport Roof for MAX or Audio Roof is required for installation.
- ECE Certified
- Requires Lights Wiring Harness (715009886) and Roof Power Cable and Cable Cover Kit (715010489) & Front Roof Liner (715009196) for vehicles not already equipped.

10" (25 cm) Double Stacked LED Light Bar (60 W)

Traxter G1, Traxter G1 MAX, Traxter G2,
Traxter G2 MAX

715010065



5,400 lumens

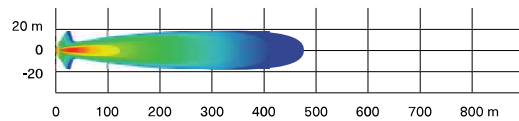

- Equipped with twelve 5 W Cree LEDs.
- 5,400 lumens.
- Packs a big punch for its size.
- Rugged and waterproof.
- Can be installed on front bumpers, Sport Roof and Bimini Roof with sun visor.
- Requires light power cable for installation.
- Lights up to more than 1,500 ft (460 m) in front of the vehicle and around 65 ft (20 m) wide on each side.
- ECE Certified
- See table for installation location and requirements.

15" (38 cm) Double Stacked LED Light Bar (90 W)

Traxter G1, Traxter G1 MAX, Traxter G2,
Traxter G2 MAX

715010066



8,400 lumens

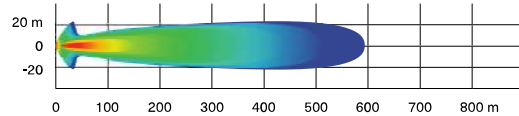

- Equipped with 18 5 W Cree LEDs.
- 8,400 lumens.
- Complements the Light Racks and most bumpers.
- Rugged and waterproof.
- Lights up to more than 1,900 ft (580 m) in front of the vehicle and around 65 ft (20 m) wide on each side.
- ECE Certified
- See table for installation location and requirements.

39" (99 cm) Double Stacked LED Light Bar (270 W)

Traxter G1, Traxter G1 MAX

715004007



24,300 lumens

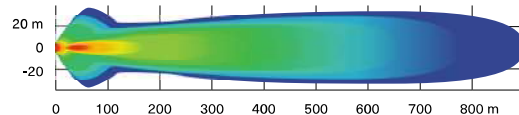

- Equipped with 54 5 W Cree LEDs.
- 24,300 lumens.
- Lights up to more than 2,900 ft (900 m) in front of the vehicle and around 115 ft (35 m) wide on each side.
- Compatible with the Adventure Roof Rack.
- Compatible with Flip Windshields and Full Windshields.
- See table for installation location and requirements.
- Not ECE Certified

4" (10 cm) Round LED Lights (2 x 25 W)

Traxter G1, Traxter G1 MAX

715002935



1,800 lumens

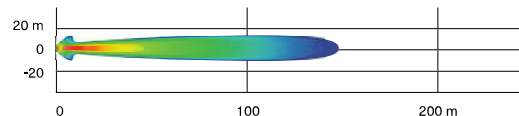

- 25 W LED spotlights.
- 1,800 lumens.
- Rugged and waterproof.
- Includes basic wiring and switch.
- Can-Am branded grill.
- Requires light power cable.
- Sold in pairs.
- Not ECE Certified
- See table for installation location and requirements.

3.5" (9 cm) LED Driving Lights (2 x 14 W)

Traxter G1, Traxter G1 MAX, Traxter G2, Traxter G2 MAX

715010094

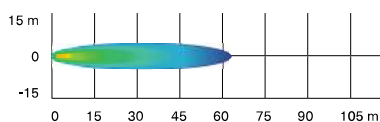

- 14 W LED lights producing 1,260 lumens each.
- Spot lens for a narrow and long light beam spread, ideal when driving at higher speeds.
- Equipped with six high-power LEDs in a heavy-duty die-cast aluminum housing.

- Features two attachment points. If one attachment point fails due to a collision, rotate to the next channel point and remount the light.
- Sold in pairs.
- ECE Certified
- See table for installation location and requirements.

3.5" (9 cm) LED Flood Lights (2 x 14 W)

Traxter G1, Traxter G1 MAX, Traxter G2, Traxter G2 MAX

715010093

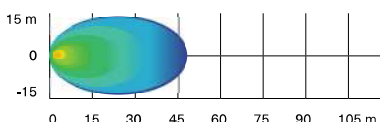

- 14 W LED lights producing 1,260 lumens each.
- Flood lens for a wide light beam spread, ideal for working applications like plowing or cornering. Suitable for dusty or foggy riding conditions.
- Equipped with six high-power LEDs in a heavy-duty die-cast aluminum housing.

- Features two attachment points. If one attachment point fails due to a collision, rotate to the next channel point and remount the light.
- Sold in pairs.
- ECE Certified
- See table for installation location and requirements.

NEW LED Light Bar Mounts

Traxter G2, Traxter G2 MAX

715009261



- Black cast-aluminum construction.
- Optimized Led Light Bar positioning to work with Can-Am flip windshields.
- Can be installed with or without roof.
- Required for SMART LED Light Bar 40" (715008747) or SMART LED Light Bar 10" (715008745).

NEW Spotlight Support Bar

Traxter G1, Traxter G1 MAX, Traxter G2, Traxter G2 MAX

715009301



- Black cast-aluminum construction and aluminum extrusion providing a mounting point for lights.
- Can be installed with or without roof.
- Required to install the 3.5" Round Lights on the roof.

Light Bar Support

Traxter G1, Traxter G1 MAX

715006226



- Mounting bracket that allows the installation of the Can-Am 39" Lightbar (715004007).
- Low and forward mounting position for a sleek look.
- Compatible with all windshields, roofs and doors.
- This accessory is not compatible with the Can-Am Audio Roof (715005206) or Can-Am Max Audio Roof (715006879).

Light Rack

Traxter G1, Traxter G1 MAX

715002456



- Rugged steel construction serves as both mount and protection for accessory light systems.
- Lights not included.
- Front Roof Liner is required for installation on the roof (except Cab models or with Deluxe Sport Roof).
- Power Cable, Sport Roof, Deluxe Sport Roof or Sport Roof for MAX required for installation.
- Integrates elegantly and seamlessly into our roof products.

Rear Cargo Light

Traxter G1, Traxter G1 MAX

715007077



- Powerful 55 W H3 illumination for rear cargo area.
- Convenient in-dash switch.
- Wiring included.
- Sport Roof (715002430) or Sport Roof for MAX (715003038) is required for installation.
- Not ECE Certified
- Not compatible with headache rack on Traxter Pro and Traxter 6x6.

RAM⁺ LED Spotlight	Traxter G1, Traxter G1 MAX	710005423
--------------------------------------	----------------------------	------------------



- 540 lumen (9 watt) heavy-duty LED spotlight standard-equipped with 1" (2.5 cm) diameter rubber-coated double ball and socket system.
 - Not ECE Certified
- Installation of some accessories shown may impact vehicle compliance with some regulations. Consult your local dealer for information.*

NEW Dome Light	Traxter G1, Traxter G1 MAX, Traxter G2, Traxter G2 MAX	715009228
-----------------------	--	------------------



- Offers an optimal visibility in the cab and integrates perfectly with the vehicle.
- 160 lumens of soft white light ensure clear visibility of the surroundings.
- Built in on/off button on the light.
- Wiring included.
- Can be installed on cage or Sport Roof.
- Not compatible with the Traxter Audio Roofs.

LED Signature Lights	Traxter G1, Traxter G1 MAX	715006896
-----------------------------	----------------------------	------------------



- The stylish LED set puts the finishing touch to your Traxter, accentuating its aggressive stance.
 - Included on Limited and Lone Star models.
- Installation of some accessories shown may impact vehicle compliance with some regulations. Consult your local dealer for information.*

NEW Round Lights ACM Wiring Harness	Traxter G2, Traxter G2 MAX	715009855
--	----------------------------	------------------



- Required to connect the 3.5" (9 cm) LED Flood and LED Driving Lights (715010093 & 715010094) to the ACM Harness.

NEW Lights Wiring Harness	Traxter G1, Traxter G1 MAX, Traxter G2, Traxter G2 MAX	715009886
----------------------------------	--	------------------



- Power cable for installation of compatible SMART LED Hood Light (715009299), SMART 10" (25 cm) LED Light Bar (715008745) or Rear LED Light (715008236).

NEW SMART 40" (102 cm) LED Light Bar Harness	Traxter G2, Traxter G2 MAX	715009930
---	----------------------------	------------------



- Required to install the SMART 40" (102 cm) LED Light Bar (715008747) if the ACM is not installed.



Treat yourself to exceptional sound on the move. Expertly tuned and DSP-calibrated, Can-Am's JL Audio-powered systems deliver precise equalization, time alignment, crossover filtering, bass boost, and more—fine-tuning every note for high-impact sound, no matter how remote the ride.

LEVEL UP YOUR SOUND

Choose the audio setup that matches your style.



LEVEL 1

Wet Sounds Stealth XT 6
Can-Am Edition
Sound Bar Level



LEVEL 2

This option* includes two 6.5" (165 mm) speakers and Frontliner PLUS, the Can-Am JL Audio Amplifier



LEVEL 3

This option includes four 6.5" (165 mm) speakers (two dash and two surround speakers) PLUS the Can-Am JL Audio Amplifier



LEVEL 4

This option includes a full roof with four or six 8" speakers, one 400 RMS, and an 800 peak watt amplifier supplied by Rockford Fosgate audio.

CRANK IT UP WITH UPGRADES

Traxter rigs equipped with levels 2–4 can be upgraded with an amplifier, rear speakers, or a subwoofer, so you can build the ultimate setup for every ride.

*Two different options depending on whether there is a 10.25" touchscreen display or not.

AUDIO & COMMUNICATION SYSTEMS

NEW Can-Am JL Audio System – Level 2	Traxter G2, Traxter G2 MAX	715009192
	<ul style="list-style-type: none"> Made using premium JL Audio components, including two 6.5" (165 mm) speakers and Front Liner. Control your music with Bluetooth connectivity. Can-Am JL Audio Amplifier included (715009229) with 280 watts. Compatible with the pre-wired Can-Am JL Audio Subwoofer & Amplifier Kit (715008094) for quick, easy installation. 	<ul style="list-style-type: none"> Rear Speaker Kvit (715009193) and Audio Roof can be added to deliver superior performance. Requires the Can-Am JL Audio Source Unit (715010002) for vehicles without 10.25" Color Touchscreen Display, installed in the center dashboard for a car-like experience. Requires the Cable Cover and Roof Power Cable Kit (715010489) for installation.

NEW Can-Am JL Audio System – Level 2 (with Source Unit) <i>(Not illustrated)</i>	Traxter G2, Traxter G2 MAX	715009194
	<ul style="list-style-type: none"> Made using premium JL Audio components, including two 6.5" (165 mm) speakers. Included weatherproof marine source unit with full color LCD display and integrated 100 watt amplifier. Add the 280 W Amplifier (715009229) for superior sound levels and to allow the installation of the Subwoofer & Amplifier Kit (715008094). 	<ul style="list-style-type: none"> Rear Speaker Kit (715009193) added to deliver superior performance. Not compatible with Wetsound Stealth XT 6 Can-Am Edition Sound Bar (715008282). Requires the Cable Cover and Roof Power Cable Kit (715010489) for installation.

NEW Can-Am JL Audio Rear Speaker Kit	Traxter G2, Traxter G2 MAX	715009193
	<ul style="list-style-type: none"> Made using premium JL Audio components, including two 6.5" (165 mm) speakers. Including the black speaker boxes and wiring harnesses. Add these to Can-Am JL Audio System – Level 2 (715009192 or 715009194) to enhance performance. 	

NEW Can-Am JL Audio System – Level 3	Traxter G2, Traxter G2 MAX	715009197
	<ul style="list-style-type: none"> Made using premium JL Audio components, including four 6.5" (165 mm) speakers (two dash and two surround speakers). Control your music with Bluetooth connectivity. Can-Am JL Audio Amplifier included (715009229) with 280 watts. Compatible with the pre-wired Can-Am JL Audio Subwoofer & Amplifier Kit (715008094) for quick, easy installation. 	<ul style="list-style-type: none"> Add the Can-Am JL Audio Roof (715009224 or 715009223) to enhance performance. Requires the Can-Am JL Audio Source Unit (715010002) for vehicles without 10.25" Color Touchscreen Display, installed in the center dashboard for a car-like experience. Requires the Cable Cover and Roof Power Cable Kit (715010489) for installation.

NEW Can-Am JL Audio Roof – Level 4	Traxter G2 Traxter G2 MAX	715009224 715009223
	<ul style="list-style-type: none"> Full roof with premium JL Audio System. Weatherproof components include four (or six for MAX) 7.7" coaxial speakers and a 500-watt amplifier (MX500/4). Speakers include an adjustable RGB LED cone illumination, controlled via an app on your smartphone. Controlled by the 10.25" Color Touchscreen Display. Easy to install and connect. Included a Dome light. If you have an ACM installed, smart mode enables automatic on/off functions of the light. Compatible with the pre-wired Can-Am JL Audio Subwoofer & Amplifier Kit (715008094) for quick, easy installation. 	<ul style="list-style-type: none"> When combined with the Can-Am Audio System – Level 3 (715009197), it provides the ultimate sound experience. Requires the Can-Am JL Audio Source Unit (715010002) for vehicles without 10.25" Color Touchscreen Display, installed in the center dashboard for a car-like experience. Requires the Cable Cover and Roof Power Cable Kit (715010489) for installation. Not compatible with the Cargo Rack Multi-position (715009148) or Cargo Rack MAX (715009170).

NEW Can-Am JL Audio Subwoofer & Amplifier Kit	Traxter G2, Traxter G2 MAX	715008094
	<ul style="list-style-type: none"> Orchestrated for outstanding sound quality and calibrated to enhance your audio experience. Makes installation a breeze by running on vehicle-specific plug-and-play wiring. Includes the MX300/1 amplifier fixed on the subwoofer to ease the installation. Designed to be tough in the most demanding riding conditions with an IP166. This 10" (254 mm) 300 watt under-seat subwoofer enhances both the driver's and the passenger's experience. 	<ul style="list-style-type: none"> Can be installed only under the passenger's seat. Combines with JL Audio sound system Level 2 to 4 to create the ultimate sound experience. Traxter MAX only: A second subwoofer can be added by using the Dual Subwoofer Harness (715010858). Not compatible with Can-Am JL Audio System – Level 2 (with Source Unit) (715009194).

NEW Can-Am JL Audio Amplifier

Traxter G2, Traxter G2 MAX

715009229

- This is a premium JL Audio MX280/4 amplifier that is used to upgrade your Can-Am JL Audio System – Level 2 (with Source Unit) (715009194) to a 280 W system.
- Designed to be Can-Am tough in the most demanding riding conditions.
- To add a subwoofer to the Can-Am JL Audio System – Level 2 (with Source Unit) (715009194), this item is required.
- Easy to install, mounting support included.
- We've got the perfect vehicle fit for seamless integration.

NEW Can-Am JL Audio Source Unit

Traxter G2, Traxter G2 MAX (without touchscreen display)

715010002

- Weatherproof Source Unit with Full-Color LCD Display.
- Includes a Digital AM/FM Tuner, Bluetooth® connectivity.
- The tough case (which is rated IP67) houses a 2.8-inch full-color LCD display.
- Day/Night mode to help visibility, even when it is bright outside.
- The audio output options include a strong amplifier that is built into the device. This amplifier can power your speakers with 100 watts.
- Required most Can-Am Audio JL levels installed on vehicles without 10.25" Color Touchscreen Display.

NEW Dual Subwoofer Harness*(Not illustrated)*

Traxter G2 MAX

715010858

- Required when installing a second subwoofer (715008094) for Traxter MAX.

Can-Am JL Audio Roof – Level 4

Traxter G1

715005206

- Full roof with sleek built-in audio.
- Fully sealed and waterproof.
- Easy to install: one wire connects the roof to the vehicle's electronics.
- Four 7.7" speakers, one 280 watt amplifier, and one weatherproof source unit supplied by JL Audio®.
- Speakers include LED lighting integrated into the grille, designed to uniformly illuminate with an RGB glow.
- A 3" full-color LCD display, with separate day/night lighting themes for visibility, even in bright sunshine.
- AM/FM tuner.
- To install the Audio Roof with the following accessories, the Power Harnesses 715003094 and 715008781 are required: Flip Glass Windshield with Wiper and Washer Kit (715002441), Windshield Wiper and Washer Kit (715001638), Front Deluxe Full Doors (715009906), Rear Deluxe Full Doors (715009907).
- Not compatible with Adventure Roof Rack or Headache Rack.
- Not compatible with 39 in. (99 cm) Double Stacked LED Light Bar (270 W) (715004007) and Light Bar Support (715006226).

Can-Am JL Audio Roof – Level 4 (MAX)

Traxter G1 MAX

715006879

- Full roof with premium JL Audio system for Traxter MAX.
- Fully sealed and waterproofed components and construction.
- Simple to install: one connector connects the roof to the vehicle's electrical system.
- Weatherproof components: six 7.7" coaxial speakers, 280 watt amplifier and 70 watt Mediamaster® source unit.
- AM/FM tuner.
- Expertly tuned for exceptional sound on the move in your Traxter MAX.
- Speakers include adjustable RGB LED cone illumination, controlled via an app on your smartphone.
- Mediamaster® source unit equipped with 3" full-color LCD display, with day/night lighting modes.
- Designed to not drain the battery.
- Specific to the type of riding.
- To install the Audio Roof with the following accessories, the Power Harnesses 715003094 & 715008781 are required: Flip Glass Windshield with Wiper & Washer Kit (715002441), Windshield Wiper & Washer Kit (715001638), Front Deluxe Full Doors (715009906), Rear Deluxe Full Doors (715009907).
- Not compatible with Adventure Roof Rack.
- Not compatible with 39 in. (99 cm) Double Stacked LED Light Bar (270 W) (715004007) & Light Bar Support (715006226).

Overhead Audio System

- Rugged waterproof Jensen¹ Bluetooth Stereo Audio System offers multi-source input: AM/FM/WB and USB (iPod® and iPhone® ready).
- Convenient white LED-backlit LCD display and buttons.
- Stream from any Bluetooth-enabled device (smartphone, MP3 player).
- Powerful 4 x 40 W amplifier with remote turn-on.
- Voice-control of AVRCP-active device.
- 30 programmable AM/FM stations with auto-store/pre-set scan.
- Separate RCA audio output and input.
- UV-resistant finish/corrosion-resistant components.
- Requires Sport Roof (715002430) or Front Roof Liner (715008226) and Power Cable (715003094).

Complete Overhead Audio System

Traxter G1, Traxter G1 MAX

715009764

- Complete with 4 ultra-sturdy outdoor speakers (2 front and 2 rear) and 4 black speaker boxes.

Overhead Front Audio System

Traxter G1, Traxter G1 MAX

715009765

- Complete with 2 ultra-sturdy front outdoor speakers and black speaker box.

Wetsound Stealth XT 6 Can-Am Edition Sound Bar	Traxter G1, Traxter G1 MAX, Traxter G2, Traxter G2 MAX	715008282
	<ul style="list-style-type: none"> Built-in Bluetooth connectivity with source control. Built-in Broadcast mode. Backlit control panel with Integrated LED RGB cabin lights. Integrated LED Dome. IP67 rated RF wireless remote control. 3.5 aux input/output. Built-in 300 W Class D amplifier. 	<ul style="list-style-type: none"> 4 marine-rated 3" full range drivers. 2 marine-rated 1" tweeters. Operating voltage: 12 V. IP rated: IP67. Length: 21.31" Width: 4.04" Height: 3.85" Sound Bar Mounting Kit required for installation.

Can-Am JL Audio Subwoofer & Amplifier Kit	Traxter G1, Traxter G1 MAX	715010050 715010342 - Sub only
	<ul style="list-style-type: none"> Orchestrated for outstanding sound quality and calibrated to enhance your audio experience. Designed to be tough in the most demanding riding conditions. Easy to install, this 10" (254 mm) under-seat 250 W subwoofer enhances both the driver's and the passenger's experience. Includes the MX 500/1 amplifier with 715010050. When combined with the Can-Am Audio Roof (715005206) or with the Can-Am Audio Roof MAX (715006879), this premium JL Audio component creates the ultimate sound experience (only compatible with JL Audio Roofs). 	

Can-Am Audio Roof Flip Kit	Traxter G1, Traxter G1 MAX, Traxter G2, Traxter G2 MAX	715007133
	<ul style="list-style-type: none"> Combines with Can-Am Audio Roofs (715005206 & 715006879) for Flip option. Not compatible with the Roof Rack. 	

Sound Bar Mounting Kit	Traxter G1, Traxter G1 MAX, Traxter G2, Traxter G2 MAX	715007840
	<ul style="list-style-type: none"> Required to install the Wetsound Stealth XT 6 Can-Am Edition Sound Bar on a Traxter and Traxter MAX. 	

ELECTRONIC ACCESSORIES

NEW Front View Camera	Traxter G2, Traxter G2 MAX	715009408
	<ul style="list-style-type: none"> Allowing clear visibility of the conditions near the front wheels. Helpful for avoiding obstacles before descending steep hills, when plowing or maneuvering in tight spaces. 	<ul style="list-style-type: none"> Offers a 170-degree viewing angle. Relays an image to the Touchscreen Display. Requires the Rear View Camera & Monitor (715009407) with models without Touchscreen Display.

NEW Rear View Camera & Monitor	Traxter G2, Traxter G2 MAX (without touchscreen display)	715009407
	<ul style="list-style-type: none"> Fully waterproof rearview mirror and monitor kit. See exactly what you need to see with the multiple camera feeds from the rear view camera. This unit is designed as a direct replacement for vehicles that come with a stock rearview mirror (the screen is integrated in the unit's replacement rearview mirror). 	<ul style="list-style-type: none"> The camera uses infrared light for night vision capabilities. Provides a 170-degree viewing angle. Designed only for models without Touchscreen Display. Possibility of adding the Front View Camera (715009408) for optimal vision around the vehicle.

Rear View Mirror & Camera Monitor	Traxter G1, Traxter G1 MAX	715009410
	<ul style="list-style-type: none"> Fully waterproof rearview mirror and monitor kit. See exactly what you need to see with the multiple camera feeds from the rear view camera. This unit replaces the stock rearview mirror (the screen is integrated into the unit's replacement rearview mirror). The camera uses infrared light for night vision capabilities. 	

NEW Power Tilt Bed

Traxter G2, Traxter G2 MAX

715009452



- Powerful cargo box tilter with dash-integrated switch.
- Load capacity of 1,000 lb.
- Electrical actuated hydraulics for a strong and quick tilting system.

Power Tilt Bed

Traxter G1 (except 6x6), Traxter G1 MAX (2020 & up), Traxter G1 PRO
Traxter G1 6x6

715007096

715007204



- Powerful cargo box tilter with dash-integrated switch.
- Electrical actuated hydraulics for a strong and quick tilting system.

Cellphone Holder

Traxter G1, Traxter G1 MAX, Traxter G2, Traxter G2 MAX

715008786



- Water resistant door allows for perfect phone positioning.
- Features capacitive and resistive touch screen technology.
- Spring system in back plate automatically adjusts for thickness.
- Fits all cellphones within 7.2" (185 mm) x 3.3" (85 mm) x 0.6" (15 mm) dimensions.
- Works with almost all charger wires.
- Does not include cellphone or charging wires.
- Requires the RAM GPS Mount (715003325) bolted directly on the dashboard for the Cellphone Holder to be supported. Can be installed with the LinQ Lite Device Holder (715009201).

RAM GPS Mount

Traxter G1, Traxter G1 MAX, Traxter G2, Traxter G2 MAX

715003325



- Allows for GPS integration onto vehicle.
- Standard AMPS hole pattern for Garmin Cradle.

Digitally Encoded Security System (D.E.S.S.™) Keys

Traxter G1, Traxter G1 MAX (2023 & prior)
Traxter G1, Traxter G1 MAX (2024 & up with HD9 & HD10 engines except for the PRO XU HD10)

715002458



- Top-security anti-theft protection for your vehicle.
- Encrypted chip technology restricts access to your vehicle's electronic ignition system.
- One vehicle/one code.
- A vibration/shock-resistant ball-and-socket design that ensures a reliable connection.
- 3 programmable modes:
 - Work mode: configurable vehicle speed limit between 20 km/h (13 mph) and 100 km/h (60 mph) that does not limit engine torque (G1 HD7, HD8). Limits vehicle speed to 40 km/h (25 mph) but does not limit engine torque (G1 HD9, HD10).
 - Normal mode: configurable, limits vehicle speed to 70 km/h (44 mph) and may have torque reduction.
 - Performance mode: No restrictions.

Digitally Encoded Security System (D.E.S.S.) Keys

Traxter G1 (2024 & up with HD7 engine)

715009300



- Top-security anti-theft protection for Can-Am vehicles.
 - The encrypted chip technology restricts access to the unit's electronic ignition system.
 - One code per vehicle.
 - Features a vibration/shock-resistant ball-and-socket design that ensures a reliable connection.
- Comes with three programmable keys, including:
 - Work key: configurable vehicle speed limit between 20 km/h (13 mph) and 100 km/h (60 mph) that does not limit engine torque.
 - Normal key: configurable, limits vehicle speed to 70 km/h (44 mph) and may have torque reduction.
 - Performance key: no restrictions.

Digitally Encoded Security System (D.E.S.S.) Green Key

Traxter G2, Traxter G2 MAX

710005232



- Top-security anti-theft protection for your vehicle.
 - Encrypted chip technology restricts access to your vehicle's electronic ignition system.
 - One vehicle/one code.
 - A vibration/shock-resistant ball-and-socket design that ensures a reliable connection.
- 3 programmable modes:
 - Work mode: configurable vehicle speed limit between 20 km/h (13 mph) and 100 km/h (60 mph) that does not limit engine torque.
 - Normal mode: configurable, limits vehicle speed to 70 km/h (44 mph) and may have torque reduction.
 - Performance mode: no restrictions.

NEW Auxiliary Battery Installation Kit

Traxter G2, Traxter G2 MAX

715009473



- Allows you to add a second 32 Ah battery for a dual battery setup that will give you the extra juice you need to power auxiliary electrical components like a sound system or winch.
- Kit includes all necessary wiring and the battery holder.
- Additional battery sold separately (710008836).
- Requires Center Underseat Storage Bin (715009199).

C-TEK charger

860200997



- CTEK, the manufacturer of the smartest battery chargers in the world, has produced a BRP specific charger for all BRP products.
- Charger is built to meet the demanding arctic conditions.
- Ask your dealer for more information.

Auxiliary Battery Installation Kit

Traxter G1, Traxter G1 MAX (2020 & up)

715006035



- Allows you to add a second 30 Ah battery for a dual battery setup that will give you the extra juice you need to power auxiliary electrical components like a sound system or winch.
 - Additional battery sold separately (515176151).
- Equipped with an integrated smart battery isolator that will prevent your auxiliary electrical components from draining your starting battery.
 - Kit includes an additional battery junction block, all necessary wiring and the battery holder.

USB Power Outlet Kit

Traxter G1, Traxter G1 MAX (2020 & up)

219400510



- Recharges your electronic devices while riding* (smartphone, MP3, heating gear, etc.).
- Dual port USB connectors.

**The power outlet is not capable of recharging all device types while riding.*

NEW Defrost, Heat & Ventilation System

Traxter G2, Traxter G2 MAX

Coming Soon



- Ventilation system design and vehicle integration have been rethought to significantly improve installation time.
 - Best integrated in-dash system on the market with 3 fan speeds and adjustable temperature.
 - Mode dial lets you choose between 5 airflow selections.
 - Adjustable/directional vents can be closed to concentrate heat toward specific areas.
 - A total of 10 vents specially positioned for windshield, window defrost and occupant heating.
- Easy-to-service air filter.
 - Includes the replacement lower dashboard compatible with the heating system.
 - For MAX models, you can add the Rear Passenger Heater Vents for rear passengers' comfort.
 - If the vehicle is not already equipped with a cab, Cable Cover and Roof Power Cable Kit (715010489) is required for window defrost.

NEW Rear Passenger Heater Vents

Traxter G2 MAX

Coming Soon



- Situated on the floor to allow the heated air to circulate effectively to the rear seats.
- Adjustable/directional vents can be closed to concentrate heat toward specific areas.
- There are two vents that are designed to help keep rear passengers cozy.
- Requires the Defrost, Heat & Ventilation System.

Defrost, Heat & Ventilation System	Traxter G1, Traxter G1 MAX 2019 & prior (not compatible with HD5 Motorization)	715004917
---	---	------------------



- Best integrated system on the market with 3-ventilation speeds and in-dash adjustable temperature.
- Adjustable/directional vents.
- 10 vents specially positioned for better windshield and side window defrosting/deicing, foot and hand heat.
- Easy-service air filter.
- Once installed, you might want to add storage space with the Lower Dashboard for Heating System and Dash Storage Compartment Net for Heating System.

Traxter G1, Traxter G1 MAX 2020 (except G1 PRO & HD5 models)

715005904

Traxter G1, Traxter G1 MAX (2021 & up)

715008093

- Best integrated in-dash system on the market with 3 fan speeds and adjustable temperature.
- Adjustable/directional vents can be closed to concentrate heat at specific areas.
- A total of 8 vents specially positioned for windshield and occupant heating.
- Easy-to-service air filter.
- Includes the replacement lower dashboard compartment for the heating system.
- Dash Storage Compartment Net for Heating System is recommended.

Heated Seat	Traxter G1, Traxter G1 MAX, Traxter G2, Traxter G2 MAX	715006112
--------------------	---	------------------



- 25 W seat heater delivers chill-free riding comfort.
- High/low temperature settings allow you to control the desired degree of warmth.
- This kit includes one carbon fiber seat heater, foam sheet and in-dash switch.
- Installs directly in the original seat cushion.
- Heated Accessories Wiring Harness (710005757 or 710006036) is required for installation on front seat.
- Heated Accessories Wiring Harness (715006004) is required for installation on rear seats on MAX models.

Heated Seat Harness for Front Seat <i>(Not illustrated)</i>	Traxter G1, Traxter G1 MAX (models with Defrost, Heat & Ventilation System), All Traxter PRO models	710006036
	Traxter G1, Traxter G1 MAX (models without Defrost, Heat & Ventilation System), Traxter G2, Traxter G2 MAX	710005757

- Electric harness required to hook up and operate heated accessories.
- Powers up to 4 accessories: 2 hand accessories (grab bar/steering wheel) and 2 seat covers.

Heated Seat Harness for Rear Seat <i>(Not illustrated)</i>	Traxter G1 MAX, Traxter G2 MAX	715006004
--	--------------------------------	------------------

- Electric harness required to hook up and operate rear heated seats.

Heated Visor Outlet	Traxter G1, Traxter G1 MAX	715001246
----------------------------	----------------------------	------------------



- Strategically positioned on vehicle to maintain your agility.
- Optional visor outlet that delivers fog-free riding.
- Quick and easy installation.
- Sold individually.
- Heated Visor not included.

WINCHES & HITCHES

CAN-AM HD WINCHES

Can-Am HD 4500 Winch

Traxter G1, Traxter G1 MAX, Traxter G2,
Traxter G2 MAX

715006416



- Ergonomic clutch handle.
- Rugged all-steel gears and bushings for more torque and durability.
- Automatic 100% load-holding brake.
- Sealed solenoid for all-weather protection.
- Weather sealed corded remote and dash mounted switch.
- EC compliant.
- CE & UKCA Compliant
- Pulling strength capability of 4,500 lb (2,041 kg).
- 43' of 1/4" (13.1 m of 6.3 mm) steel wire cable.
- Heavy-duty 4-way roller fairlead.
- Winch Electrical Harness (715007078) is required for installation on a Traxter 2021 and prior. Winch Electrical Harness (715008152) is required for installation on a Traxter Base and DPS™ 2022 and up.

Can-Am HD 4500-S Winch

Traxter G1, Traxter G1 MAX, Traxter G2,
Traxter G2 MAX

715006417



- Ergonomic clutch handle.
- Rugged all-steel gears and bushings for more torque and durability.
- Automatic 100% load-holding brake.
- Sealed solenoid for all-weather protection.
- Weather sealed corded remote and dash mounted switch.
- Pulling strength capability of 4,500 lb (2,041 kg).
- 50' of 1/4" (15.2 m of 6.35 mm) synthetic rope.
- Corrosion-proof aluminum Hawse fairlead.
- Winch Electrical Harness (715007078) is required for installation on a Traxter 2021 and prior. Winch Electrical Harness (715008152) is required for installation on a Traxter Base, DPS, DPS Cab 2022 and up.
- CE & UKCA Compliant

Cargo Bed Winch

Traxter G2, Traxter G2 MAX
Traxter G1, Traxter G1 MAX

715009419 NEW

715006355



- Allows you to pull heavy loads into the cargo box easily.
- Perfect for hunting applications when it comes to loading game.
- Includes support base made of heavy-duty 2" (5 cm) steel tubing, winch and weather-sealed corded remote.
- 750 lb (340 kg) maximum pulling capacity.
- Electronic security module to prevent vehicle damage that could occur if loaded vehicle exceeds manufacturer's gross weight rating.
- Adapter Kit (715004709) is required for installation with Gear Rail Adapter (715003392).
- Traxter 6x6 and PRO: Requires Power Tilt Bed (715009338).
- Not CE Certified
- Not available in Europe

NEW Winch Cable Stopper

All Can-Am HD Winches

715009921



- Made of EPDM, a highly durable synthetic rubber.
- The Winch Cable Stopper isn't just for looks. It helps extend the life of the winch, rope, hook, and fairlead.
- In addition, the split design makes it easy to install.

Synthetic Winch Cable*

Can-Am HD Winch
WARN Winch

715006430

715007783



- 50' of 1/4" (15.2 m of 6.35 mm) synthetic cable for WARN winch.
- WARN Hawse Fairlead is required when upgrading to a synthetic cable to avoid damage and premature wear of the cable.

**Ask your dealer or visit canamoffroad.com for price details.*

Replacement Wire Rope*

Can-Am HD Winch
WARN Winch

705014978

715006699



- 43' of 1/4" (13.1 m of 6.3 mm) wire rope.
- 4,500 lb (2,041 kg) pulling strength.

**Ask your dealer or visit canamoffroad.com for price details.*

Synthetic Cable Extension

715001120



- Lightweight 1/4" (6.35 mm) diameter, easy to handle and won't rattle in cargo box.
- Easily attaches to winch cable to provide additional 50' (15.2 m) of distance.
- 4,500 lb (2,041 kg) single line capacity.

WARN Hawse Fairlead*

With WARN winch

715007785

- Double-powder-coated construction.
- Required to use the Synthetic Winch Cable (715007783) on WARN winches.
- To be used with synthetic winch cables only.

Can-Am HD Hawse Fairlead

With Can-Am HD winch

715006426

- A must when upgrading your winch with a synthetic cable, this corrosion-proof aluminum Hawse fairlead will prevent the cable from snapping in a corner of a roller fairlead and from wearing prematurely due to the rough surface of the worn roller guide.
- Must be used with synthetic cables only.

Roller Fairlead

With Can-Am HD winch

710007082

- Suggested when changing the wire rope.
- Heavy-duty replacement fairlead for winches.

NEW Wireless Winch Remote

With Can-Am HD Winch

715008286

- On/Off and Winch In / Winch Out buttons with LED indicator light.
- Large Winch In / Winch Out buttons for easy activation with gloves.
- Ergonomic remote handle shape with a trigger-like holding protrusion.
- Quick and easy to install, thanks to a wiring harness with an integrated antenna and all necessary mounting hardware.
- Allows you to operate your winch from anywhere within a 50' (15.2 m) radius, increasing your recovery options.
- All components are IP67 sealing rated.
- The remote also floats in case it's dropped during a deep water recovery.
- Dash and handlebar mounting options.
- Compatible with all Can-Am HD winches.

Wired Remote Control

With Can-Am HD winch

715006504

- This kit allows winch owners to add the hand-held remote to vehicles with a stock winch.
- Works in conjunction with the mini-rocker switch.
- Remote control and connection socket are included with Can-Am HD winch.

NEW Trailer Hitch Ball Mount

Traxter G1, Traxter G1 MAX, Traxter G2, Traxter G2 MAX

**715010023 (US)
715010617 (EU)**

- Designed to fit trailer hitches with a 2" x 2" (5 cm x 5 cm) receiver tube opening.
- It offers 3,500 lb (1,590 kg) of towing capacity.
- Solid forged steel construction.
- Equipped with a hole to accept a 3/4" (1.9 cm) ball shank.
- 1" (2.5 cm) raised or 2" (5 cm) lowered for precise trailer leveling.
- Hitch ball not included.

Lower Front Receiver Hitch

Traxter G1, Traxter G1 MAX

715002519

- Heavy-duty 1,500 lb (680 kg) towing capacity, 2" (5 cm) receiver hitch.
- Expand and enhance functionality by pairing it with Higher Front Receiver Hitch and Removable Winch Mounting Kit (need to relocate winch from its standard mounting position).

Higher Front Receiver Hitch

Traxter G1, Traxter G1 MAX (except Limited models)

715003109

- Heavy-duty 1,500 lb (680 kg) towing capacity, 2" (5 cm) receiver hitch.
- No need to relocate winch from its standard mounting position.

Winch Electrical Harness

(Not illustrated)

Traxter G1, Traxter G1 MAX (2019 & prior)	715003093
Traxter G1, Traxter G1 MAX (2020 & 2021)	715007078
Traxter G1, Traxter G1 MAX 2022	715008152

- Required to install a winch on a Traxter without a factory-installed winch.

Rubber Receiver Plug

705204503



- Rubber cap for 2" (5 cm) Receiver Hitch.

PERFORMANCE

Performance Half Shaft

Traxter G1, Traxter G1 MAX (2019 & prior – except X mr, XT-P and XT CAB 2018-2019)	705402353
Traxter G1, Traxter G1 MAX XT Cab 2018-2019, Lone Star Edition 2019 & prior	705402575



- High-performance design ideal for off-road use, with superior wheel power and acceleration for racing, dunes and desert riding.
- Includes CVs, shaft and boots with the best suited geometry for your Can-Am vehicle.

Brake Holding Mechanism

Traxter G1, Traxter G1 MAX	715004733
----------------------------	------------------



- Maintains constant pressure on the brake pedal to keep the vehicle from moving on sloped terrain, without having to put the transmission in P (park).
- Standard equipment on T-category models

Heavy-Duty Spring Kit

Traxter G1, Traxter G1 MAX 62" with Double A-Arm Front Suspension	715005084
---	------------------



- This set of heavy-duty springs will stiffen your suspension.
- Perfect for reducing overall vehicle sag when shocks are under heavy demand: heavy loading and hauling or for snow clearing.
- Complete kit of 4 springs.
- Not compatible with Traxter HD5, HD10, XT CAB, Mossy Oak Edition & X mr models and Traxter MAX.

NEW Magneto Stator Kit (1,700 Watt)

Traxter G2, Traxter G2 MAX (with HD11 engine only)	715009450
--	------------------



- Increases the magneto output to 1,700 W.
- Includes rotor, stator and regulator.
- Improves charging when several accessories are installed.
- Standard on HVAC models.

850 W Magneto Kit

Traxter G1, Traxter G1 MAX (2020 & up except HD5 & HD7)	715007122
---	------------------



- Increases the magneto output to 850 W.
- Includes rotor, stator and regulator.

Emergency Kit

715006102



- Complete emergency kit provides all essential equipment and supplies to get out of most unfavorable situations powersport enthusiasts can find themselves in.
- Includes: jumper cables, air compressor, tire repair kit, first aid kit, ratchet tie-down, duct tape, 3,300 lb (1,500 kg) tow strap, zip ties, cloth rags.

AIR INTAKES

NEW Snorkel Kit

(Not illustrated)

Traxter G2, Traxter G2 MAX

715009151

- Raises point of engine and CVT air intakes so vehicle can be semi-submersed in water/mud without taking in water to the engine.
- Not compatible with Rear Glass Window (715007079), Rear Glass Window with Sliding Panel (715007080), Headache Rack (715009171), Bed Wall Extender (715009166, 715009590 & 715010833).
- Standard on Traxter X mr models.
- Not compatible with cab models.

Snorkel Kit

Traxter G1, Traxter G1 MAX 2018 & up (except HD5, HD7, Limited and PRO)

715003727



- Raises point of engine and CVT air intakes so vehicle can be semi-submersed in water/mud without taking in water to the engine.
 - Not compatible with Headache Racks, Gear Rail equipment, DragonFire Cargo Bed Roll Bar and Windshield Wiper & Washer Kit.
 - Snorkel Extension Kit is available for roof level air intake and CVT exhaust.
 - Standard on Traxter X mr models.
- Installation of some accessories shown may impact vehicle compliance with some regulations. Consult your local dealer for information.*

Sealed Air Box

(Not illustrated)

Traxter G1, Traxter G1 MAX (2017 & prior)

707801033

- Required when installing the Snorkel Kit (715003727) on Traxter and Traxter MAX 2017 and prior models.
- Standard on Traxter 2018 and up models.

Snorkel Pre-Filter

Traxter G1, Traxter G1 MAX (except PRO models)

715005597



- Pre-filter specifically for snorkels.
- Adds extra protection to your engine in harsh riding conditions.
- Helps keep air filter cleaner.
- Filter blocks particles larger than 0.005" (0.13 mm).
- Necessary to maintain vehicle warranty when tracks are installed for winter use.
- For Traxter HD10 models 2020 & up: Replace CVT intake of snorkel kit with CVT relocation kit 715008651 or 703501211.

Air Intake Pre-Filter

Traxter G1 (except X mr models), G1 MAX

715003483



- Adds extra protection to your engine in harsh riding conditions.
- Helps keep air filter cleaner.
- Filter blocks particles larger than 0.007" (0.19 mm).
- Easy, tool-less installation.
- Necessary to maintain vehicle warranty when tracks are installed.
- Required to install the Apache and Backcountry Track Systems.
- Not compatible with Snorkel Kit.

Foam Air Filter by Twin AIR†

Traxter G1, Traxter G1 MAX

715003630



- The best choice for the harshest conditions.
- Multiple staged oiled filtering foam for superior dust retaining capacity with high air flow.
- Washable and reusable.

CVT Auxiliary Intake & Pre-Filter Kit

Traxter G1, Traxter G1 MAX (without Snorkel Kit)

703501210

Traxter G1, Traxter G1 MAX (X mr models or models with Snorkel Kit)

703501211**



- The CVT Auxiliary Intake & Pre-Filter Kit is MANDATORY for track-equipped 2020 to 2022 and some 2023 Traxter HD10 models used in snow conditions and highly recommended for other models.
- This kit is sold separately.

**Comes from the factory on some MY23; inspect the vehicle to confirm.*

Mandatory on all MY20 and up Traxter HD10 models equipped with a snorkel.

***When installed on X mr models or models with Snorkel Kit, it temporarily relocates CVT air intake to the standard factory location.*

No traction? No problem. Apache XC Tracks are built for serious terrain. With improved flotation and stability, they tackle deep snow, mud, and everything in between. Engineered for optimized attack angles, reduced noise, and unmatched durability, this system means all-season dominance.

DESIGNED FOR PEAK PERFORMANCE

Aggressive lugs deliver max traction without sacrificing handling. A reinforced steel frame boosts strength, while the center slide improves alignment and reduces de-tracking. Reduced NVH levels and the wheel placement ensure smooth, quiet power delivery. Plus, wheel longevity is increased with replaceable wheel bearings.



APACHE TRACK SYSTEMS

APACHE XC LT LIMITED WARRANTY*

Apache XC LT Track System	Traxter G1, Traxter G1 MAX, Traxter G2, Traxter G2 MAX (except 6x6)	715007719
 <ul style="list-style-type: none"> • Long Track version. • Brand-new track design to optimize driving off-road and in deep snow conditions. • Reduction in steering effort thanks to the 4-wheel tandem. • Improved steering precision from optimized wheel and track rolling band alignment. • 1.25" (3.175 cm) lugs in the front and in the back for better traction and lateral stability. • Track width: front 12.5" and rear 15". • Adds 3" (7.62 cm) of ground clearance versus 27" tires. • Additional shaft dampers, tandem dampers, track design and wheel layout significantly reduce NVH (noise vibration harshness). <p><i>Installation of some accessories shown may impact vehicle compliance with some regulations. Consult your local dealer for information.</i></p>	<ul style="list-style-type: none"> • Central guide for optimized track alignment and reduced occurrences of detracking. • Optimized track layout with increased angle of attack for better obstacle crossing and snow performance. • Stamped and welded steel frame for improved strength and durability. • Easy maintenance with replaceable hub and wheel bearings. • Main hub has oil bath and 3 bearings for consistent lubrication and improved durability. • Mounting kit sold separately. • See table for fit, compatibility and requirements. 	

Apache XC LT Mounting Kit  <ul style="list-style-type: none"> • Required for installation of the Apache XC LT Track System. • DPS module and Engine Pre-Filter not included. • The CVT Auxiliary Intake & Pre-Filter Kit is MANDATORY for track-equipped 2020 and up Traxter HD10 models used in snow conditions and highly recommended for other models.* • This kit is sold separately. • See table for fit, compatibility and requirements. <p><i>*Comes from the factory on some 2023 and up models, inspect the vehicle to confirm. Mandatory on all 2020 and up Traxter HD10 models equipped with a snorkel.</i></p> <p><i>Installation of some accessories shown may impact vehicle compliance with some regulations. Consult your local dealer for information.</i></p>		715006891 715008612 715009252 NEW
--	--	--

*The limited warranty is subject to the exclusions, limitations of liabilities and all other terms and conditions of BRP's standard limited warranty.

APACHE BACKCOUNTRY

LIMITED WARRANTY*

Apache Backcountry LT Track Kit

Traxter G1, Traxter G1 MAX (except 6x6)

715005891

Traxter G2, Traxter G2 MAX (except 6x6)

715004734



- Tracks designed to deliver the best snow performance on the market with unmatched flotation level and traction on snow surface.
- Large contact patch, 37% bigger than the Apache 360 LT.
- Impressive added ground clearance of 7" (18 cm) helps keep the vehicle over the snow.
- Lightweight snowmobile-inspired rail design.
- Aggressive track design with 2" (5 cm) lug height for maximum traction on snow.
- Apache Backcountry LT Mounting Kit, Track DPS Module and Engine Pre-Filter are required and sold separately.

- The CVT Auxiliary Intake & Pre-Filter Kit is MANDATORY for track-equipped 2020 to 2022 and some 2023' Traxter HD10 models and highly recommended for other models. This kit is sold separately.
- For winter use only.
- Track installation will affect vehicle width and length.
- Fine-tune your track system using extra Idler Wheels, Sliders with Vespel Inserts and Rail Ice Scratcher.

**Comes from the factory on some MY23, inspect the vehicle to confirm.*

Mandatory on all MY20 and up Traxter HD10 models equipped with a snorkel.

Installation of some accessories shown may impact vehicle compliance with some regulations. Consult your local dealer for information.

APACHE 360

LIMITED WARRANTY*

Apache Backcountry LT Mount Kit

(Not illustrated)

See table for fit, compatibility and requirements.

715009932 **NEW**

715005888

715005493

715006196

- Required for installation of the Apache Backcountry Track LT System.
- DPS Module and Engine Pre-Filter are required and sold separately.
- The CVT Auxiliary Intake & Pre-Filter Kit is MANDATORY for track-equipped 2020 to 2022 and some 2023' Traxter HD10 models and highly recommended for other models. This kit is sold separately.

**Comes from the factory on some MY23, inspect the vehicle to confirm.*

Mandatory on all MY20 and up Traxter HD10 models equipped with a snorkel.

Installation of some accessories shown may impact vehicle compliance with some regulations. Consult your local dealer for information.

Apache 360 LT Track System

Traxter G1, Traxter G1 MAX (except 6x6)

715005103



- Multifunctional tracks designed to support heavy loads and to fit on most Can-Am off-road vehicles.
- Extra contact patch adjustment for better performance over rough terrain.
- Contact patch is 7 to 9% bigger than the Apache 360's.
- Average ground clearance of 16" (41 cm). 1" (2.5 cm) lugs in the front and 1.25" (3.2 cm) in the back.
- EC compliant.
- Apache 360 LT Mounting Kit, Track DPS Module and Engine Pre-Filter Kit are required and sold separately.

- The CVT Auxiliary Intake & Pre-Filter Kit is MANDATORY for track-equipped 2020 to 2022 and some 2023' Traxter HD10 models used in snow conditions and highly recommended for other models. This kit is sold separately.

**Comes from the factory on some MY23, inspect the vehicle to confirm.*

Mandatory on all MY20 and up Traxter HD10 models equipped with a snorkel.

Installation of some accessories shown may impact vehicle compliance with some regulations. Consult your local dealer for information.

Apache 360 LT Mounting Kit

(Not illustrated)

See table for fit, compatibility and requirements.

715004832

- Required for installation of the Apache 360 LT Track System.
- DPS module and Engine Pre-Filter not included.
- The CVT Auxiliary Intake & Pre-Filter Kit is MANDATORY for track-equipped 2020 to 2022 and some 2023' Traxter HD10 models used in snow conditions and highly recommended for other models.

- This kit is sold separately.

**Comes from the factory on some MY23, inspect the vehicle to confirm.*

Mandatory on all MY20 and up Traxter HD10 models equipped with a snorkel.

Installation of some accessories shown may impact vehicle compliance with some regulations. Consult your local dealer for information.

APACHE ACCESSORIES

Track DPS Module

(Not illustrated)

See table for fit, compatibility and requirements.

715006266

715007338

- An innovative DPS module that ensures speedometer accuracy and optimized steering assist, which make for perfect track control and riding ease.
- Required to install the Apache and Backcountry Track Systems.

Installation of some accessories shown may impact vehicle compliance with some regulations. Consult your local dealer for information.

Rail Ice Scratchers

Apache Backcountry and Backcountry LT Track Systems

860201728



- Provide additional lubrication in hard and icy conditions and extend slider life.
- Rail mounted, small, light.
- Design expands on coil concept to allow reversing without damage.
- Easily stored when not in use.



- Additional wheel kit for Backcountry LT rear tracks.
- Reduces drag and rolling resistance in hard snow conditions or when transporting heavier loads.
- Extends slider life in hard snow conditions.
- Includes two wheels, cross shaft and mounting hardware per kit to service one track corner.
- Up to two kits per rear track can be installed.

APACHE TRACK SYSTEMS FITTING GUIDE

APACHE XC LT

Model Year	Generation	Front Suspension Type	Track	Track Mount	Track DPS Module	CVT Pre-Filter	Engine Pre-Filter
2024 & Prior	Traxter G1	Double A-Arm	715007719	715006891	715007338	703501210 (w/o Snorkel Kit) 703501211 (w/ Snorkel Kit)	715003483 (w/o Snorkel Kit) 715005597 (w/ Snorkel Kit)
2020 to 2022	Traxter G1	Arched Double A-Arm without Swaybar		715008612			
2023 & Up	Traxter G1	Arched Double A-Arm with and without Swaybar		715006891			
2024 & Up	Traxter G1	Double A-Arm		715006266			
2026	Traxter G2	Arched Double A-Arm with Swaybar		715009252	Not Required	Not Required	

APACHE BACKCOUNTRY LT

Model Year	Generation	Front Suspension Type	Track	Track Mount	Track DPS Module	CVT Pre-Filter	Engine Pre-Filter
2024 & Prior	Traxter G1	Double A-Arm	715005891	715005888	715007338	703501210 (w/o Snorkel Kit) 703501211 (w/ Snorkel Kit)	715003483 (w/o Snorkel Kit) 715005597 (w/ Snorkel Kit)
2025 & Prior	Traxter G1	Arched Double A-Arm with Swaybar		715006196			
2020 & Up	Traxter G1	Arched Double A-Arm without Swaybar		715005493			
2024 & Up	Traxter G1	Double A-Arm		715005888			
2026	Traxter G2	Arched Double A-Arm with Swaybar		715004734	715009932	715006266	Not required

APACHE 360 LT

Model Year	Generation	Front Suspension Type	Track	Track Mount	Track DPS Module	CVT Pre-Filter	Engine Pre-Filter
2018 to 2022	Traxter G1	Arched Double A-Arm with Swaybar	715005103	715004832	715007338	703501210 (w/o Snorkel Kit) 703501211 (w/ Snorkel Kit)	715003483 (w/o Snorkel Kit) 715005597 (w/ Snorkel Kit)

TRAXTERS FRONT SUSPENSIONS REFERENCE GUIDE

MY	Front Suspension Type	
MY25	Traxter 6x6 DPS HD10	Arched double A-arm / 11 in. (27.9 cm) suspension travel
	Traxter MAX XU HD10 T ABS	
	Traxter PRO XU HD10 T ABS	
	Traxter XU HD10 T ABS	
	Traxter XU HD9 T ABS	
MY26	Traxter 6x6 DPS HD10	Arched double A-arm / 11 in. (27.9 cm) suspension travel
	Traxter PRO XU HD10 T ABS	
	Traxter XU HD9 T ABS	
MY25	Traxter DPS HD9	Double A-arm / 10 in. (25.4 cm) suspension travel
	Traxter HD7 T	
	Traxter HD9 T	
	Traxter MAX DPS HD9	
	Traxter XU HD7 T	
MY26	Traxter DPS HD9	Double A-arm / 10 in. (25.4 cm) suspension travel
	Traxter HD7 T	
	Traxter HD9 T	
	Traxter MAX DPS HD9	
MY26	Traxter XU HD7 T	Double A-arm / 10 in. (25.4 cm) suspension travel
	Traxter XU HD11 T ABS	
MY26	Traxter MAX XU HD11 T ABS	Arched Double A-Arm with sway bar / 12 in. (30.5 cm) suspension travel
	Traxter XU HD11 T ABS	

*The limited warranty is subject to the exclusions, limitations of liabilities and all other terms and conditions of BRP's standard limited warranty.

Traxter G2 models now come plow-ready, no mounting plate required. The push frame mounts directly to the chassis for quick setup and maximum pushing power. From the season's first snowfall to the last cleanup, they're designed to deliver powerful, precise performance every time.

TRAXTER G2: READY TO PLOW AND PUSH HARD

Start with a blade and push frame, then dial it in with accessories like edge markers, a plow angling system, and drift cutters. Easy to install, engineered to last, and tough enough for winter jobs—this lineup covers every plowing need.



PROMOUNT PLOWS

CAN-AM ProMount FLEX2 PLOW KIT

Can-Am ProMount Flex2 72" (183 cm) Blade Plow Kit	Traxter G1, Traxter G1 MAX	715008170
	Traxter G2, Traxter G2 MAX	715009134 NEW



- These kits include:
 - Can-Am ProMount Flex2 Blade.
 - Push Frame with Quick-Attach System.
 - Mounting Plate (Traxter G1 models only).

CAN-AM ProMount FLEX2 BLADES

Can-Am ProMount Flex2 66" (168 cm) Blade	Fits ProMount Push Frame	715009883
---	--------------------------	------------------



- Plow blade made of UHMWPE, flexible and impact absorbing material prevents damaging your plow when accidental impact occurs.
- Replaceable wear blade.
- Large pin designed for easy blade rotation to eliminate snow buildup at pivot point.
- Blade design provides best snow roll-off at any angle.
- Clears 60" (152 cm) when plow is fully angled.
- Blade height of 17" (43 cm).
- Compatible with Can-Am ProMount Blade accessories to further enhance plow versatility.

Can-Am ProMount Flex2 72" (183 cm) Blade	Fits ProMount Push Frame	715009868
---	--------------------------	------------------



- Plow blade made of UHMWPE, flexible and impact absorbing material prevents damaging your plow when accidental impact occurs.
- Replaceable wear blade.
- Large pin designed for easy blade rotation to eliminate snow buildup at pivot point.
- Blade design provides best snow roll-off at any angle.
- Clears 66" (168 cm) when plow is fully angled.
- Blade height of 17" (43 cm).
- Compatible with Can-Am ProMount Blade accessories to further enhance plow versatility.

CAN-AM ProMount STEEL PLOW KIT

Can-Am ProMount Steel 72" (183 cm) Blade Plow Kit	Traxter G1, Traxter G1 MAX	■ 715008172
	Traxter G2, Traxter G2 MAX	■ 715009135 NEW



- These kits include:
 - Can-Am ProMount Steel Blade
 - Push Frame with Quick-Attach System
 - Mounting Plate (Traxter G1 models only).

CAN-AM ProMount STEEL BLADES

Can-Am ProMount Steel 66" (168 cm) Blade	Fits ProMount Push Frame	■ 715009881 • Black
--	--------------------------	---------------------



- Plow blade made from 12-gauge steel.
- Replaceable wear blade.
- Large pin designed for easy blade rotation to eliminate snow buildup at pivot point.
- Blade design provides best snow roll-off at any angle.
- Clears 60" (152 cm) when plow is fully angled.
- Blade height of 17" (43 cm).
- Compatible with Can-Am ProMount Blade accessories to further enhance plow versatility.
- Not compatible with S3 High Clearance Front A-Arm.

Can-Am ProMount Steel 72" (183 cm) Blade	Fits ProMount Push Frame	■ 715009877 • Black
--	--------------------------	---------------------



- Plow blade made from 12-gauge steel.
- Replaceable wear blade.
- Large pin designed for easy blade rotation to eliminate snow buildup at pivot point.
- Blade design provides best snow roll-off at any angle.
- Clears 66" (168 cm) when plow is fully angled.
- Blade height of 17" (43 cm).
- Compatible with Can-Am ProMount Blade accessories to further enhance plow versatility.
- Not compatible with S3 High Clearance Front A-Arm.

ProMount PLOW KITS – REFERENCE CHARTS

	TRAXTER G1				TRAXTER G2	
	66" Black Steel	66" Flex2	72" Black Steel	72" Flex2	72" Flex2	72" Black Steel
Plow Kit	-	-	715008172	715008170	715009134	715009135
Blade	715009881	715009883	715009877	715009868	715009868	715009877
Push Frame	715008116	715008116	715008116	715008116	715008888	715008888
Mounting Plate	715007745	715007745	715007745	715007745	-	-

CAN-AM ProMount ANGLE PLOWS

Can-Am ProMount 66" (168 cm) Steel Oneway State Blade	Fits ProMount Push Frame	715007263
---	--------------------------	-----------



- Make the job easier with the right tools, clear long alleys and make the task easier by sending the snow further out of the way.
- Wing end of plow measures 26" (67 cm) high and tapers down to 16" (41 cm).
- One-way "winged" state plow designed to throw snow higher.
- Rubber Flap (715007299) designed to keep snow away from the driver is offered as accessory (sold separately).
- Can-Am branded.

Can-Am ProMount 72" (183 cm) Steel Oneway State Blade	Fits ProMount Push Frame	715009879
---	--------------------------	-----------



- Make the job easier with the right tools, clear long alleys and make the task easier by sending the snow further out of the way.
- Wing end of plow measures 26" (67 cm) high and tapers down to 16" (41 cm).
- One-way "winged" state plow designed to throw snow higher.
- Rubber flap (715007299) designed to keep snow away from the driver is offered as accessory (sold separately).
- Can-Am branded.

CAN-AM ProMount PLOW ACCESSORIES

NEW Can-Am ProMount Push Frame with Quick-Attach System

Traxter G2, Traxter G2 MAX

715008888



- New platform offering a plow ready vehicle frame with an integrated lead-in designed to receive the plow push frame hooks—no mounting plate needed!
- Adjustable roller and gas strut to support the front hooks at the appropriate height for your vehicle—no need to lift the plow push frame to hook it.
- Precise location of the rear hooks allows to clip with confidence each time.
- Attaches directly to the vehicle for quick installation—no mounting plate needed!
- Heavy-duty steel tubes designed to withstand the roughest use.
- Mount location provides ultimate push strength and traction.
- Designed for maximum plow lift height.
- Features a self-aligning quick-attach system, an easy foot-release pedal and an ergonomic handle for plow angle adjustment.
- Allows blade to swivel left or right, five positions.
- Compatible with all Can-Am ProMount blades.
- Plow Limit Switch recommended to extend winch cable lifespan.
- Plow Roller Fairlead included.
- Requires winch.

Can-Am ProMount Edge Markers

Fits ProMount Plow Blades

715004206



- Help locate the edges of your plow.
- Height: 24" (60 cm).
- Sold in pairs.
- Compatible with Can-Am ProMount Steel and Flex2 blades with or without Blade Extensions (except for the Can-Am ProMount Steel 54" (137 cm) Blades).

Can-Am ProMount 66" (168 cm) Plastic Wear Blade

Fits ProMount Plow Blades

715004482

Can-Am ProMount 72" (183 cm) Plastic Wear Blade

Fits ProMount Plow Blades

715004483



- To help prevent scratches on smooth driveways and markable surfaces.

Can-Am ProMount Drift Cutters

Fits ProMount Plow Blades

715006258



- Help keep snow in the plow.
- Dimensions: 17" x 13" (43.2 cm x 33 cm).
- Sold in pairs.
- Compatible with Can-Am ProMount Steel and Flex2 blades with or without Blade Extensions (except for the Can-Am ProMount Steel 54" (137 cm) Blades).

Back Drag Blade

(Not illustrated)

Fits ProMount Plows (60" and more)

715007794

- ¼ thick steel swivel scraper.
- Lifts up when the vehicle is moving forward so as not to affect the scraping.
- Increased capacity to pull snow.
- More aggressive scraping in reverse mode.
- Lifts the scraper off the ground so that it scrapes evenly.
- Adjustable in length for compatibility with 60", 66" and 72" blades.
- Compatible with ProMount blades (Flex and Steel).

Can-Am ProMount Push Frame with Quick-Attach System

Traxter G1, Traxter G1 MAX

715008116



- Heavy-duty steel tubes designed to withstand the roughest use.
- Mid-mount carriage provides ultimate push strength and traction.
- Designed for maximum plow lift height.
- Features a self aligning quick-attach system, an easy foot release pedal and an ergonomic handle for plow angle adjustment.
- Plow Limit Switch recommended to extend winch cable lifespan.
- Can-Am ProMount Mounting Plate required for installation.
- Blade swivels left or right, 5 positions.
- Large pin designed for easy blade rotation to eliminate dirt and snow buildup at pivot point.

NEW Can-Am ProMount Push Frame Extension

Traxter G2, Traxter G2 MAX

715009461



- Improved angle for a better ground contact.
- 13.5" (35 cm) push frame extension required when plow is installed with Apache Track systems.
- Compatible with the Can-Am ProMount Push Frame with Quick-Attach System (715008888).

Can-Am ProMount Push Frame Extension	Traxter G1, Traxter G1 MAX	715006257
---	----------------------------	------------------



- 12" (30 cm) push frame extension required when plow is installed with Apache Track Systems.
- Compatible with the Can-Am ProMount Push Frame with Quick-Attach System (715008116).

Can-Am ProMount Mounting Plate	Traxter G1, Traxter G1 MAX (2021 & prior)	715007743
---------------------------------------	---	------------------



- Required to install the Can-Am ProMount Push Frame with Quick-Attach System.
- Mounting plate precision-designed to stay on year round without compromising ground clearance.
- Not compatible with S3 Front High Clearance A-Arm (715003784).

Can-Am ProMount Mounting Plate	Traxter G1, Traxter G1 MAX (2022 & up)	715007745
---------------------------------------	--	------------------



- Required to install the Can-Am ProMount Push Frame with Quick-Attach System.
- Mounting plate precision-designed to stay on year round without compromising ground clearance.
- Comes with the Plow Roller Fairlead.
- Not compatible with S3 Front High Clearance A-Arm (715003784).

NEW Can-Am ProMount Plow Angling System	Traxter G2, Traxter G2 MAX	715009133
--	----------------------------	------------------



- Improved operation speed for quicker plow angle adjustments.
- Converts your plow system into an easy-to-control accessory from the driver's seat.
- Allows you to have full up/down and left/right plow control at your fingertips with the supplied joystick.
- Using one hand to control all plow motions allows you to easily concentrate and manage your plowing tasks with ease.
- Compatible with the SSV ProMount Push Frame (715008888 or 715008116) and Blades.
- Not compatible with Apache Backcountry LT Track System.
- Winch and plow system sold separately.

Can-Am ProMount Plow Angling System	Traxter G1, Traxter G1 MAX	715009241
--	----------------------------	------------------



- Converts your plow system into an easy-to-control unit from the driver's seat.
- Allows you to have full up/down and left/right plow control at your fingertips with the supplied joystick.
- Using one hand to control all plow motions allows you to easily concentrate and manage your plowing tasks.
- Compatible with the SxS ProMount Push Frame and Blade.
- Not compatible with Apache Backcountry LT Track System.
- Push Frame Extension (715006257) is required for installation with the Front Rancher Bumper.
- Winch and plow sold separately.

NEW Plow Quick Adjust Blade Shoes	ProMount Steel & Flex2 Blades 60" (all years), 66" & 72" (2025 & prior)	715009751
--	---	------------------



- Zinc-plated steel construction for corrosion resistance.
- Easy and quick tool-free adjustment.
- Pre-set adjustment for different heights.
- Larger shoe diameter for greater ground contact.
- Improved shoe design for better flotation.

ProMount Plow Limit Switch <i>(Not illustrated)</i>	Traxter G1, Traxter G1 MAX	715006259
---	----------------------------	------------------



- For controlling the cable tension when over-raising your plow system.
- Prevents winch, plow push frame and vehicle damage.
- Sensor relocated for optimal lift height.

Plow Roller Fairlead	Traxter G1, Traxter G1 MAX, Traxter G2, Traxter G2 MAX	715001223
-----------------------------	--	------------------



- Cylindrical roller fairlead.
- Larger diameter lower roller reduces wear on wire rope for plow application.
- Can be used with all ProMount plows.

SUPER-DUTY PLOW SYSTEM

Super-Duty 72" (183 cm) Blade Plow Kits	Traxter G1, Traxter G1 MAX	715003416
	<ul style="list-style-type: none"> • A comprehensive plow system with manual lift and angling. • Ultra-durable 72" (183 cm) blade made of 12-gauge steel with integrated reinforcement and heavy-duty push tubes to tackle the most demanding jobs. • Requires a winch for raising and lowering. • Convenient disconnect system for quick and easy installation or removal. • Front mount provides minimum 11" (28 cm) lift distance. • Not compatible with Apache XC LT Tracks. <p>This kit includes:</p> <ul style="list-style-type: none"> - 72" (183 cm) Super-Duty Plow. - Super-Duty Plow Push Frame. - Super-Duty Plow Mounting Kit. 	
Super-Duty Plow Hydraulic Angling Kit	Traxter G1, Traxter G1 MAX (2019 & prior) Traxter G1, Traxter G1 MAX (2020 & up)	715002840 715006038
	<ul style="list-style-type: none"> • Allows you to have full up/down and left/right plow control at your fingertips. • Pre-assembled, it comes with everything you need to turn your Super-Duty Plow into a quick, easy-to-control unit from the driver's seat. • Using one hand to control all plow motions with the supplied joystick will allow you to easily concentrate and manage your plowing tasks. • With this commercial grade kit, you will reliably send snow exactly where you want all winter long. • Winch and plow sold separately. 	
Super-Duty Plow Push Frame Extension <i>(Not illustrated)</i>	Super-Duty Plow	715001221
<ul style="list-style-type: none"> • Extension to use the Super-Duty Plow with the Apache 360 LT Track System. • Comes with Plow Magnetic Switch and Plow Pulley. • Requires Front Bumper or Front Accessory Bar for installation. • Not compatible with Apache XC LT Tracks. 		
Plow Blade Extensions	Super-Duty Plow	715001217
	<ul style="list-style-type: none"> • Side extensions for widening your plow blade by 6" (15 cm) on each side. • Include rubber flaps for extension parts. • Sold in pairs. 	
Plow Edge Markers <i>(Not illustrated)</i>	Super-Duty Plow	715001216
<ul style="list-style-type: none"> • For a more accurate view of the width of your plow. • Allows you to work closely around objects. 		
Plow Drift Cutter <i>(Not illustrated)</i>	Super-Duty Plow	715001218
<ul style="list-style-type: none"> • Keeps snow securely in the plow. • Allows you to cut a cleaner pass. • Sold individually. 		
Plow Limit Switch	Traxter G1, Traxter G1 MAX Traxter G2, Traxter G2 MAX	715006259 715009894 NEW
	<ul style="list-style-type: none"> • For controlling the cable tension when over-raising your plow system. • Prevents winch, plow push frame and vehicle damage. 	
Plow Rubber Flap <i>(Not illustrated)</i>	Super-Duty Plow	715001219
<ul style="list-style-type: none"> • Keeps snow away from the driver and helps snow to roll in front of the plow. 		
Plow Pulley <i>(Not illustrated)</i>	Super-Duty Plow	715002042
<ul style="list-style-type: none"> • For use with the Super-Duty Plow. • Helps winching efficiency. • Requires Front XT Bumper. 		

Plow Magnetic Switch
(Not illustrated)

Super-Duty Plow

715001995

- Magnetic switch that stops the winch to prevent cable, winch and frame damage.
- For use with Super-Duty Plow.

COVERS & ADD-ONS

Trailing Cover

Traxter G1

715004453

Traxter G1 MAX

715004454



- Heavy-duty canvas made of UV-resistant solution-dyed polyester.
- Inner soft liner protects windshield and colored panels from abrasion.
- All high-abrasion areas are reinforced with a double canvas layer.
- Weather-resistant trailing cover protects your vehicle during storage and transportation.
- Opening for fuel cap.
- Quick and easy installation.
- Designed to perfectly fit your vehicle with or without Can-Am accessories.
- Does not fit with Adventure Roof Rack (715003870).

Bolt-On¹ Retractable Ratcheting Tie-Downs

295101072



- Perfect for transporting your powersport vehicle or securing loads.
- Mount easily: Bolt on any flat surface (e.g., truck bed or frame).
- 1" x 6' (2.5 cm x 1.8 m) tie-down strap with heavy-duty stitching that delivers a 500 lb (226 kg) working load strength and 1,500 lb (680 kg) break strength.
- Convenient retractable push button automatically slackens, spools and stores away strap, while the ratchet mechanism tightens the strap snugly to secure your vehicle or load into place.
- Rubber ratcheting handle provides firm grip, and the hook is vinyl coated to protect whatever surface it hooks into.
- Sold in pairs.

Ratchet Tie-Downs

■ **715008309** • Black/Gray



- 400 lb (181 kg) safe working load.
- 1" x 10' (2.5 cm x 3 m) strap with Sea-Doo, Ski-Doo and Can-Am logos.
- Deluxe ratchet with rubber handle.
- Coated S hooks.
- Pack of 2.

Heavy-Duty Ratchet Tie-Down

715008308



- 1,000 lb (454 kg) safe working load.
- 1.5" x 6' (38 mm x 1.8 m) strap with BRP brands.
- Deluxe ratchet with rubber handle.
- Black-coated clip hooks.
- 12" (300 mm) webbing included.
- Pack of two.

CAN-AM MAVERICK R



CAN-AM MAVERICK R

COMPARATIVE CHART 74

ACCESSORIES 76

Roofs	77
Windshields & Wind Protection	77
Mirrors	79
Doors	79
HMWPE Skid Plates	80
Bumpers & Protection	81
LinQ: Easy On, Easy Off Cargo	83
Racks & Storage	88
ACM & SMART Accessories	91
Lights	98
Audio Systems	99
Electrical & Electronic Accessories	100
Winches	101
Performance	102







MAVERICK R X RC 999T DCT SAS

MAVERICK R X RS 999T DCT

COLOR OPTIONS

LOFT GREEN SATIN

TRIPLE BLACK

		LOFT GREEN SATIN	TRIPLE BLACK
ENGINES	Type	999T DCT	999T DCT
	Fuel Delivery System	240 hp, Rotax 999T engine, 999 cc Turbocharged Triple-cylinder engine, liquid cooled with integrated intercooler and high-performance air filter	240 hp, Rotax 999T engine, 999 cc Turbocharged Triple-cylinder engine, liquid cooled with integrated intercooler and high-performance air filter
	Transmission	Intelligent Throttle Control (ITC™) with Electronic Fuel Injection (EFI)	Intelligent Throttle Control (ITC™) with Electronic Fuel Injection (EFI)
	Drive Train	Rotax DCT, 7 Speed with High & Extra Low range	Rotax DCT, 7 Speed with High & Low range
	Power Steering	Lockable front differential with exclusive Smart-Lok® True 2WD / 4WD with front diff. lock / 4WD TRAIL ACTIV / 4WD TRAIL / 4WD ROCK	Lockable front differential with exclusive Smart-Lok® True 2WD / 4WD with front diff. lock / 4WD TRAIL ACTIV / 4WD TRAIL
	Power Steering	Gen 2 Tri-mode DPS High torque	Gen 2 Tri-mode DPS High torque
SUSPENSIONS	Front Suspension	Forged Aluminum heavy duty Tall Knuckle Double A-arm with sway bar / 25 in. (63.5 cm) suspension travel	Forged Aluminum heavy duty Tall Knuckle - Double A-arm with sway bar / 25 in. (63.5 cm) suspension travel
	Front Shocks	FOX† 2.5 PODIUM† Piggyback with bypass and Smart-Shox technology featuring Live Valve Gen 3 (Dual Valve compression & rebound)	FOX† 2.5 PODIUM RC2† Piggyback with bypass, dual speed compression and rebound adjustments
	Rear Suspension	4 Link Trailing arm with Forged Aluminum heavy duty Tall Knuckle / 26 in. (66 cm) suspension travel	4 Link Trailing arm with Forged Aluminum heavy duty Tall Knuckle / 25.5 in. (64.8 cm) suspension travel
	Rear Shocks	FOX† 3.0 PODIUM† Piggyback with bypass and Smart-Shox technology featuring Live Valve Gen 3 (Dual Valve compression & rebound)	FOX† 3.0 PODIUM RC2† Piggyback with bypass, dual speed compression and rebound adjustments
TIRES / WHEELS	Front / Rear Tires	XPS Hammer King 35 x 10 x 16 in.	ITP XNR Tenacity 32 x 10 x 16 in.
	Wheels	16 in. Aluminum flow formed beadlock	16 in. Aluminum FlowFormed Beadlock
BRAKES	Front	32 mm hydraulic triple piston caliper with a 265 mm disc	32 mm hydraulic triple piston caliper with a 265 mm disc
	Rear	32 mm hydraulic twin piston caliper with a 255 mm disc	30 mm hydraulic twin piston caliper with a 255 mm disc
DIMENSIONS / CAPACITIES	Cage	High strength (Dual phase) steel tubing and stampings	High strength (Dual phase) steel tubing and stampings
	Estimated Dry Weight*	2,460 lb (1,118 kg)	2,240 lb (1,016kg)
	L x W x H	147.4 x 78.1 x 72.6 in. (374.3 x 198.4 x 184.5 cm)	140 x 78.1 x 71.5 in. (355.6 x 198.5 x 181.5 cm)
	Wheelbase	110 in. (279.1 cm)	108 in. (274.3 cm)
	Ground Clearance	18 in. (45.7 cm)	17 in. (43.2 cm)
	Cargo Box Capacity	200 lb (90 kg)	200 lb (90 kg)
	Fuel Capacity	Total: 2.1 gal (8.1 L) 13.2 Gal (50 L)	Total: 2.1 gal (8.1 L) 13.2 Gal (50 L)
FEATURES	Gauge	4.5 in. wide digital display with keypad & 10.25 in. touchscreen display	4.5 in. wide digital display with keypad & 10.25 in. touchscreen display
	Magneto	1700-W	1700-W
	Instrumentation	USB A (charging port & communication port) DC outlet (10-A)	USB A (2 charging port & 1 communication port) DC outlet (10-A)
	Lighting	Premium high-performance LED headlights Can-Am LED signature with start-up animation	Premium high-performance LED headlights Can-Am LED signature
	Winch	4,500 lb (2,041 kg) winch with synthetic rope and roller fairlead	Winch-ready bumper (4,500 lb / 2,041 kg winch not installed)
	Anti-theft System	RF Digitally Encoded Security System (D.E.S.S.™) with Start/Stop button	RF Digitally Encoded Security System (D.E.S.S.™) with Start/Stop button
Protection	Full hard roof Premium half doors Front lower deflector Front / Rear anchor Full HD HMW plastic skid plate Front bumper Front intrusion bar Rock slider (UHMWPE) Rock guard	Full hard roof Premium half doors Front lower deflector Front / Rear anchor Full plastic skid plate	



MAVERICK R X RS 999T DCT SAS

MAVERICK R MAX X RS 999T DCT SAS

COLOR OPTIONS		DUSTY NAVY	DUSTY NAVY
ENGINES	Type	999T DCT	999T DCT
	Fuel Delivery System	240 hp, Rotax 999T DCT engine, 999cc Turbocharged Triple-cylinder engine, liquid cooled with integrated intercooler and high-performance air filter	240 hp, Rotax 999T DCT engine, 999cc Turbocharged Triple-cylinder engine, liquid cooled with integrated intercooler and high-performance air filter
	Transmission	Intelligent Throttle Control (ITC™) with Electronic Fuel Injection (EFI)	Intelligent Throttle Control (ITC™) with Electronic Fuel Injection (EFI)
	Drive Train	Rotax DCT, 7 Speed with High & Low range	Rotax DCT, 7 Speed with High & Extra Low range
	Power Steering	Lockable front differential with exclusive Smart-Lok® True 2WD / 4WD with front diff. lock / 4WD TRAIL ACTIV / 4WD TRAIL	Lockable front differential with exclusive Smart-Lok® True 2WD / 4WD with front diff. lock / 4WD TRAIL ACTIV / 4WD TRAIL
	Power Steering	Gen 2 Tri-mode DPS High torque	Gen 2 Tri-mode DPS High torque
SUSPENSIONS	Front Suspension	Forged Aluminum heavy duty Tall Knuckle - Double A-arm with sway bar / 25 in. (63.5 cm) suspension travel	Forged Aluminum heavy duty Tall Knuckle Double A-arm with sway bar / 24 in. (61 cm) suspension travel
	Front Shocks	FOX† 2.5 PODIUM† Piggyback with bypass and Smart-Shox technology featuring Live Valve Gen 3 (Dual Valve compression & rebound)	FOX† 2.5 PODIUM† RC2† Piggyback with bypass and Smart-Shox technology featuring Live Valve Gen 3 (Dual Valve compression & rebound)
	Rear Suspension	4 Link Trailing arm with Forged Aluminum heavy duty Tall Knuckle / 26 in. (66 cm) suspension travel with Smart-Shox	4 Link Trailing arm with Forged Aluminum heavy duty Tall Knuckle / 24 in. (61 cm) suspension travel
	Rear Shocks	FOX† 3.0 PODIUM† Piggyback with bypass and Smart-Shox technology featuring Live Valve Gen 3 (Dual Valve compression & rebound)	FOX† 3.0 PODIUM† Piggyback with bypass and Smart-Shox technology featuring Live Valve Gen 3 (Dual Valve compression & rebound)
TIRES / WHEELS	Front / Rear Tires	ITP XNR Tenacity 32 x 10 x 16 in.	XPS Trac Force 32 x 10 x 16 in.
	Wheels	16 in. Aluminum FlowFormed Beadlock	16 in. Aluminum Flow Formed Beadlock
BRAKES	Front	32 mm hydraulic triple piston caliper with a 265 mm disc	32 mm hydraulic triple piston caliper with a 265 mm disc
	Rear	30 mm hydraulic twin piston caliper with a 255 mm disc	32 mm hydraulic twin piston caliper with a 255 mm disc
DIMENSIONS / CAPACITIES	Cage	High strength (Dual phase) steel tubing and stampings	High strength steel (Dual phase) steel tubing and stampings
	Estimated Dry Weight*	2,250 lb (1,020kg)	2,660 lb (1210 kg)
	L x W x H	140 x 78.1 x 71.5 in. (355.6 x 198.5 x 181.5 cm)	175 x 78.1 x 69.2 in. (444.7 x 198.4 x 175.7 cm.)
	Wheelbase	108 in. (274.3 cm)	142.5 in. (365 cm)
	Ground Clearance	17 in. (43.2 cm)	17 in. (43.2 cm)
	Cargo Box Capacity	200 lb (90 kg)	200 lb (90 kg)
	Storage Capacity	Total: 2.1 gal (8.1 L)	Total: 2.1 gal (8.1 L)
	Fuel Capacity	13.2 Gal (50 L)	13.2 Gal (50 L)
FEATURES	Gauge	4.5 in. wide digital display with keypad & 10.25 in. touchscreen display	4.5 in. wide digital display with keypad & 10.25 in. touchscreen display
	Magneto	1700-W	1700-W
	Instrumentation	USB A (2 charging port & 1 communication port) DC outlet (10-A)	USB A (2 charging port & 1 communication port) DC outlet (10-A)
	Lighting	Premium high-performance LED headlights Can-Am LED signature	Premium high-performance LED headlights Can-Am LED signature
	Winch	Winch-ready bumper (4,500 lb / 2,041 kg winch not installed)	Winch-ready bumper (4,500 lb / 2,041 kg winch not installed)
	Anti-theft System	RF Digitally Encoded Security System (D.E.S.S.™) with Start/Stop button	RF Digitally Encoded Security System (D.E.S.S.™) with Start/Stop button
	Protection	Full hard roof Premium half doors Front lower deflector Front / Rear anchor Full plastic skid plate	Full hard roof Premium half doors Front lower deflector Front / Rear anchor Full HD HMW plastic skid plate Rock guard

MAVERICK R HERO UNITS PACKAGES

ESSENTIALS

PACKAGE	DESCRIPTION	MAVERICK R
Starter	Electronic Device Holder	715007176
	Color Touchscreen Display Protector	860202680
	Can-Am JL Audio Roof – Level 4	715007309 / 715007967
	Glass Windshield	715010203
	Cold Air Roof Scoop	715008280 / 715008301
	Soft Upper Door Panels	715007432 / 715007894
	Aluminum Side Mirrors	715007363
	Emergency Kit	715006102

* To complete the package we recommend the installation of a Can-Am HD Winch if not coming with the unit.

+

Protection	Desert Rear Bumpers	715007172
	Rock Sliders	715007170 / 715007922
	HMWPE Skid Plate Protection Kit	715007373

* To complete the package we recommend the installation of a Front Bumper if not coming with the unit.

+

Cargo	Upper Door Storage Bags	715008065
	Shoulder Storage Bag	715007371
	LinQ Side Cargo Boxes (13.5 L)	715007372
	LinQ Trunk Box (96 L)	715007182

+

Smart	Accessory Control Module	715010097*
	Rear ACM Harness	715009268
	SMART Control Center for ACM	715010834
	SMART Integrated LED Side Mirror Lights	715007185
	SMART Integrated LED Hood Light	715007378
	SMART Integrated LED Roof Light	715007322
	SMART Intermittent Wiper & Washer Kit	715007173

* Except X RC models.

** In X RC models will require the X RC Roof Harness to install the SMART Integrated LED Roof Light.

ROOFS

Sport Roof	Maverick R	715007364
	Maverick R MAX	715008074



- Impact-resistant injected polypropylene.
- Provides excellent protection from the elements and downhill visibility.
- Designed to work with the Cold Air Roof Scoop.
- Windshield compatible.

Cold Air Roof Scoop	Maverick R	715008280
	Maverick R MAX	715008301



- Feeds fresh air to the engine compartment.
- Sleek design for a sleek racing look.
- Increases cold air to the intake to prevent power loss.
- Required when using a full windshield.
- Requires a Sport Roof or Can-Am JL Audio Roof – Level 4.
- Not compatible with the Audio Roof Flip Kit.

WINDSHIELDS & WIND PROTECTION

WINDSHIELDS

Powerflip Windshield	Maverick R, Maverick R MAX	715009900
-----------------------------	----------------------------	------------------



- The PowerFlip Windshield is equipped with electric cylinders that allow the rider to adjust the windshield opening at the touch of a button.
- High-impact-resistant Quantum[®] hardcoated polycarbonate full windshield with a rubber seal contour and a tinted top section.
- Allows you to quickly adapt to changing conditions by adjusting the windshield as you go.
- Can be fully opened for optimal visibility and ventilation, fully closed for maximum protection from the elements, or somewhere in between.
- You have an infinite number of opening possibilities depending on your protection, visibility and airflow preferences.
- Requires a Cold Air Roof Scoop (715008280 or 715008301).
- Needs Accessory Control Module (ACM) (715010097) or Powerflip Windshield Harness (715008854) for installation.
- Not compatible with SMART Integrated LED Roof Light (715007322) and Audio Roof Flip Kit (715008164).

Glass Windshield	Maverick R, Maverick R MAX	715010203
-------------------------	----------------------------	------------------



- Curved and laminated glass full windshield.
- Seals firmly against the cage and protects both the rider and the passenger from the elements.
- Provides maximum optical clarity and abrasion resistance.
- Must be used with the Wiper & Washer Kit for clear visibility during severe riding conditions, including mud riding.
- Use with rear wind protection to maximize passenger comfort.
- Must be used with the Cold Air Roof Scoop (715008280 or 715008301).
- Compatible with the SMART Integrated Roof LED Light.
- Not compatible with the Audio Roof Flip Kit (715008164).

Full Windshield – Hardcoated	Maverick R, Maverick R MAX	715007321
-------------------------------------	----------------------------	------------------



- Highly impact-resistant Quantum[®] hardcoated polycarbonate full windshield.
- Formed polycarbonate construction for enhanced rigidity.
- Provides excellent optical clarity and better abrasion resistance.
- Protects the driver and the passenger from the elements.
- Quick and easy tool-less removal.
- Use with rear wind protection to maximize comfort for the passenger.
- Can be used with the Windshield Wiper & Washer Kit (715007173) (light-duty usage only).
- Compatible with SMART Integrated Roof LED Light.
- Must be used with the Cold Air Roof Scoop (715008280 or 715008301).
- Not compatible with the Audio Roof Flip Kit (715008164).

SMART PowerFlip Intermittent Windshield Wiper & Washer Kit

Maverick R, Maverick R MAX

715008555



- Washer fluid dispenser is perfectly concealed on the vehicle.
- Must be installed with the PowerFlip Windshield (715009900) (sold separately).
- SMART and fixed intermittence wiper speed feature available when the kit is installed in combination with ACM.
- Electric harness required (715008855) to hook up and operate the SMART PowerFlip Intermittent Windshield Wiper & Washer Kit in ON/OFF functionality when the ACM is not installed (sold separately).

Powerflip Windshield Harness

Maverick R, Maverick R MAX

715008854



- Electric harness required to hook up and operate the Powerflip Windshield (715009900) for on/off function when ACM is not installed.

SMART Intermittent Wiper & Washer Kit

Maverick R, Maverick R MAX

715007173



- An ideal way to keep your windshield clear in the rain, or while riding through mud and water.
- The wiper mechanism and washer fluid dispenser are perfectly concealed on the vehicle.
- The wiper and washer fluid dispenser installs at the bottom of the windscreen for maximum visibility.
- For use on glass or hardcoated windshields.
- SMART and fixed intermittence wiper speed feature available when the kit is installed in combination with ACM.
- Electric harness required (715008855) to hook up and operate the SMART Intermittent Windshield Wiper & Washer Kit in ON/OFF functionality when the ACM is not installed (sold separately).

Wiper & Washer Kit Wiring Harness

Maverick R, Maverick R MAX

715008855



- Electric harness required to hook up and operate in ON/OFF functionality the SMART PowerFlip Intermittent Windshield Wiper & Washer Kit and the SMART Intermittent Windshield Wiper & Washer Kit.

Manual Wiper Kit

Maverick R, Maverick R MAX

715009424



- Single manual wiper that can be used to clear windshield of debris.
- Easy to install system that requires no electrical hookup.
- Large ergonomic handle provides a good grip over the entire sweeping surface.
- Compatible with glass and hardcoated windshields that use top mounted wipers.

REAR WIND PROTECTION

Rear Polycarbonate Window

Maverick R, Maverick R MAX

715007315



- High impact-resistant polycarbonate window.
- Reduces windshield backdraft and stops dust and rain from entering the cabin for added comfort.
- Quick and easy installation.
- Designed to work with Can-Am's JL Audio Level – 3 and 5 rear speakers, and all roofs.

Rear Wind Screen for Speakers

Maverick R, Maverick R MAX

715009175



- Full rear mesh screen reduces windshield backdraft for added cabin comfort.
- Installs quickly and easily on roll cage.
- Holes allowing the clearance of audio surround speakers.

Rear Wind Screen

Maverick R, Maverick R MAX

715007317

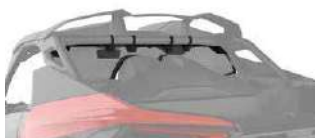

- Full rear mesh screen reduces windshield backdraft for added cabin comfort.
- Installs quickly and easily on roll cage.
- Not compatible with Can-Am JL Audio System – Level 3 (715007954) and Level 5 (715007957).

MIRRORS

Aluminum Side Mirrors

Maverick R, Maverick R MAX

715007363



- Sleek design.
- High-quality black molded aluminum for extreme durability.
- The convex surface provides a wider field of view and better visibility around the unit.
- Can be installed at any height on the cage A-pillar for optimized rider vision.
- Possibility to install the Integrated LED Side Mirror Lights (715007185).
- Adjustable ball-joint mirrors.
- Possibility to fold down the mirrors (fold-away mechanism).
- Compatible with windshields and upper door net.
- Sold in pairs.

Side Mirrors

Maverick R, Maverick R MAX

715007188



- Sleek design.
- High-impact resistant plastic mirrors.
- The convex surface provides a wider field of view and better visibility around the unit. Can be installed at any height on the cage A-pillar for optimized rider vision.
- Adjustable ball-joint mirrors.
- Possibility to fold down the mirrors (fold-away mechanism).
- Compatible with windshields and upper door net.
- Sold in pairs.

Rear View Mirror and Camera Monitor

Maverick R, Maverick R MAX

715009410



- Fully waterproof rearview mirror and monitor kit.
- See exactly what you need to see with the multiple camera feeds from the rear view camera.
- This unit replaces the stock rearview mirror (the screen is integrated in the unit's replacement rearview mirror).
- The camera uses infrared light for night vision capabilities.

DOORS

NEW Soft Upper Door Panels

Maverick R

715007432 • 2 doors

Maverick R MAX

715007894 • 4 doors



- Weather-resistant panels reinforced with aluminum frame offer good protection from the elements.
- This extension is an excellent addition to the half-door, providing full coverage.
- Made of heavy-duty UV-resistant solution-dyed polyester canvas for excellent resistance to tear and abrasion.
- Zip-down windows made of clear vinyl for added ventilation with heavy duty zippers.
- Ensures high sealing edge performance.
- Easy to use, it follows the door's movements, facilitating ingress and egress.

Upper Wind Nets

Maverick R

715007376

Maverick R MAX

715007962 **NEW**



- Complete mesh screen net with a steel frame attaches to the doors of the vehicle for added protection from the wind and mud.
- Easy to use, it follows the door's movements, facilitating ingress and egress.
- Net zips up and down for added ventilation when required.
- The window can be rolled down and attached with a strap to hold it in position.

HMWPE SKID PLATES

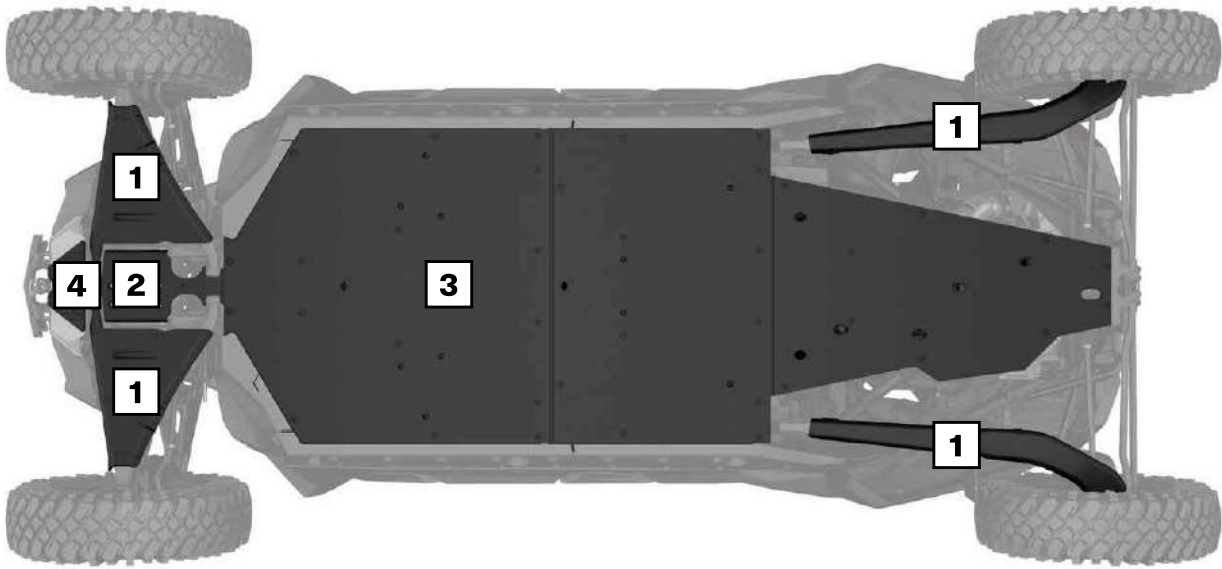

Our plastic plates glide smoothly and silently over obstacles, offering great protection in rough terrain. Made of abrasion-resistant thermoformed $\frac{3}{8}$ " (10 mm) thick High Molecular Weight Polyethylene (HMWPE).

- Lighter than aluminum.
- Superior stress crack resistance.
- High-impact strength.

MAVERICK R

**MAVERICK R
MAX**

HMWPE SKID PLATE PROTECTION KIT

715007373

-

INDIVIDUAL HMWPE SKID PLATES

1	HMWPE Front A-Arm and Trailing Arm Protectors	715007183	715007183
2	HMWPE Front Skid Plate	715007313	715007313
3	HMWPE Underbelly Plate	715007314	-
4	HMWPE Front (Nose) Skid Plate	715010009	715010009

BUMPERS & PROTECTION

BUMPERS

NEW Front Bumper X rc

Maverick R, Maverick R MAX

■ **715010008** • Black



- Sleek and rugged design.
- Provides added protection without sacrificing the agility and performance of the vehicle.
- Made of heavy-duty steel tubing to protect the front of the unit.
- Inside and outside anti-corrosion coating with durable powder coat finish.
- Combine with the Rock Sliders and Rear Bumper for ultimate protection.
- Requires Front Bumper X rc Light Support (715010532) installation of lights.
- Winch compatible.

Trail Front Bumpers

Maverick R, Maverick R MAX

■ **715010071** • Black
 ■ **715010072** • Yellow
 ■ **715009925** • Legion Red



- Can-Am's largest front bumper protects the headlights and radiator area of the unit.
- Added heavy-duty protection in extreme driving conditions.
- Made of 1.5" (3.8 cm) diameter steel tubing.
- Anti-corrosion coating with durable powder coat finish.
- Combine with the Rock Sliders and Rear Bumper for ultimate protection.
- Features integrated mounting points for lights.
- Winch compatible.

Desert Front Bumpers

Maverick R, Maverick R MAX

■ **715007311** • Black
 ■ **715007691** • Yellow
 ■ **715009926** • Legion Red



- Sleek and rugged design.
- Provides added protection without sacrificing the agility and performance of the vehicle.
- Made of heavy-duty steel profiled tubing to protect the front of the unit.
- Inside and outside anti-corrosion coating with durable powder coat finish.
- Combine with the Rock Sliders and Rear Bumper for ultimate protection.
- Features integrated mounting points for lights.
- Winch compatible.

Dune Front Bumpers

Maverick R, Maverick R MAX

■ **715007169** • Black
 ■ **715007305** • Raw Metal



- Highly integrated bumper that creates a more pronounced attack angle and provides added protection to the vehicle.
- Allows for better ground clearance.
- The sleek design gives the unit a sportier look.
- Made of heavy-duty steel with a 1/8" (3 mm) aluminum plate.
- Inside and outside anti-corrosion coating with durable powder coat finish.
- Features an integrated Tow Hook.
- Not winch compatible.

Desert Rear Bumpers

Maverick R, Maverick R MAX

■ **715007172** • Black
 ■ **715007694** • Yellow
 ■ **715009924** • Legion Red



- Rugged design.
- Provides added protection to the rear of the unit without sacrificing the agility and performance of the vehicle.
- Gives riders extra grip on the bumper and improves accessibility to rear cargo.
- Made of heavy-duty steel profiled tubing.
- Inside and outside anti-corrosion coating with durable powder coat finish.
- Combine with the Rock Sliders and Front Bumper for ultimate protection.

ROCK SLIDERS

	Maverick R	<ul style="list-style-type: none"> ■ 715007170 • Black ■ 715007693 • Yellow ■ 715009923 • Legion Red
Rock Sliders	Maverick R MAX	<ul style="list-style-type: none"> ■ 715007922 • Black ■ 715007923 • Yellow ■ 715009922 • Legion Red

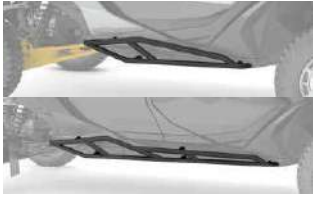

- Protect the vehicle's sides against obstacles.
- With added grip on top to improve accessibility of the roof cargo.
- Made of unique heavy-duty steel profiled tubing.
- Inside and outside anti-corrosion coating with durable powder coat finish.
- Combine with the Front and Rear Bumpers for ultimate protection.
- Sold in pairs.

HMW-HDPE Rock Sliders

Maverick R

715008142



- The sleek design gives the vehicle a sportier look.
- Tight integration with the unit's body to provide maximum obstacle clearance and outstanding protection.
- Made of combination of HMWPE and HDPE for extra durability.
- Add the Dune Front Bumper for ultimate protection and integrated lights for optimal visibility.
- Sold in pairs.

INTRUSION BAR

Front Intrusion Bar

Maverick R, Maverick R MAX

■ **715007312** • Black



- The steel intrusion bar matches the vehicle's styling and enhances its visual impact.
- The tube's design doesn't obstruct the rider's line of sight and reduces blind spots for increased visibility.
- Inside and outside anti-corrosion coating with durable powder coat finish.
- Compatible with the 40" (102 cm) Baja Designs OnX6 Arc LED Light Bar (710006818) and SMART Integrated LED Roof Light (715007322).
- Compatible with all windshields.

LINQ: EASY ON, EASY OFF CARGO



MAVERICK R'S LINQ ACCESSORIES

MOUNTING LOCATION AND REQUIREMENTS

<ul style="list-style-type: none"> No tools needed: Quickly install and remove accessories by hand Equip your Can-Am for specialized tasks in no time Sturdy mounting system that holds up to the roughest terrain 	Standard Cargo Bed	LinQ® Pivoting Rack 715009465	Adventure Roof Rack 715007186
LinQ ACCESSORIES WITH 16" BASE <ul style="list-style-type: none"> LinQ anchors mounted 16 inches apart, center-to-center. Lower loading capacity than the LinQ with 36" base accessories. Can be used on Can-Am ATV and SxS vehicles, Can-Am Spyder and Ryker vehicles, Sea-Doo watercraft and Ski-Doo snowmobiles. 			
NEW LinQ Rigid Cooler 4.7 US Gal (18 L) 715010491	Central position: No further requirements Other positions: LinQ Base Installation Kit 715008125 (1 set needed/accessory)	LinQ Base Installation Kit 715008125 (1 set needed/accessory)	LinQ Base Installation Kit 715008125 (1 set needed/accessory)
NEW LinQ Cooler 5.3 US Gal (20 L) 295101257 • Gray	Central position: No further requirements	No compatibility	No compatibility
LinQ 11.4 US Gal (43 L) Cooler 715007825 • Black 715009276 • Gray	Central position: No further requirements	No compatibility	No compatibility
LinQ 4.2 Gal Cooler 295100698 • White 219400964 • Black	Central position: No further requirements (fit on stock mounted LinQ anchors) Other positions: LinQ Base Installation Kit 715008125 (1 set needed/accessory)	LinQ Base Installation Kit 715008125 (1 set needed/accessory)	LinQ Base Installation Kit 715008125 (1 set needed/accessory)
LinQ Tool Kit 715006829			
LinQ Tool Box 715008111			
LinQ SR 5.5 Gal (21 L) Bag 860202449			
LinQ 4.5 Gal (17 L) Sport Bag 860202447			
LinQ Modular Box 715005494 • (10 L) 715007112 • (20 L) 715006830 • (30 L)			
LinQ Roll-Top Bag 715008110			
LinQ 26 US Gal (100 L) Explorer Bag 295101016			
LinQ 5.3 US Gal (20 L) Semi-Rigid Cooler 295101252			
LinQ ACCESSORIES WITH 36" BASE <ul style="list-style-type: none"> Mount on LinQ racks often used by Can-Am ORV vehicles. Higher loading capacity than the LinQ with 16" base accessories. Usage is limited to Can-Am ORV vehicles. 			
LinQ Trunk Box (87 L) – G3L 715009312	No further requirements (fit on stock mounted LinQ anchors)	LinQ Base Installation Kit 715008125 (2 sets needed/accessory)	LinQ Base Installation Kit 715008125 (2 sets needed/accessory)
LinQ Cargo Box (53 L) 715006997			
LinQ Low Profile Box (63 L) 715007827			
LinQ Cargo Basket (90 L) 715005274			
LinQ 9.2 Gal (35 L) Cooler 715006998			
LinQ CARGO ACCESSORIES			
LinQ Trunk Box (96 L) 715007182	No further requirements (fit on stock mounted LinQ anchors)	No compatibility	No compatibility
LinQ Side Cargo Boxes (13.5 L) 715007372			
LinQ HOLDERS			
LinQ Gear Grips 715005340	No further requirements	LinQ Base Installation Kit 715008125 (1 set needed)	Side wall installation LinQ Adapters 715003058
LinQ Tool Holder 715007358			

The LinQ system is BRP's game-changing, tool-free cargo solution. Snap gear on or off in seconds. No fuss, no rattle, just rock-solid mounting on any terrain.

LINQ SYSTEM ADVANTAGE

ORIGINAL LinQ SYSTEM

Handles medium- to large-sized gear with two anchor setups: the 16" base for standard accessories and the 36" base for racks and serious payloads.

LinQ LITE

Made for smaller items, lightweight gear you can hang from rails or vertical mounts.



LinQ ACCESSORIES WITH 16" BASE

NEW LinQ Rigid Cooler 4.7 US Gal (18 L)

Maverick R, Maverick R MAX

■ 715010491 • Black



- Versatile LinQ 16" configuration fits many vehicles.
- Durable rotomolded rigid construction.
- Molded-in handles for quick installation and removal.
- High quality insulation for optimal ice retention.
- Sealed lid for airtight, weather-tight closure.
- Ergonomic and secure latch system offers excellent sealing.
- 4.7 US gal (18 L) capacity.
- See table for installation location and requirements.

NEW LinQ Cooler 5.3 US Gal (20 L)

Maverick R, Maverick R MAX

■ 295101257 • Gray



- LinQ-mounted for fast, easy and secure storage.
- Locks in place with just a quarter turn.
- High-quality insulation for optimal ice retention.
- Keeps ice cold for 5 days.
- Rotomolded construction for exceptional rigidity and durability.
- Sealed lid for airtight, weather-tight closure.
- Rigid handles make transportation easy.
- Horizontal locking handles allow for installation of LinQ Lite accessories.
- Holds thirty-four 355 ml cans.
- 5.3 US gal (20 L) capacity.
- Exterior dimensions: 21" L x 15" W x 14" H (52 cm L x 38 cm W x 35 cm H).
- Interior dimensions: 15" L x 10" W x 9" H (39 cm L x 26 cm W x 23 cm H).
- LinQ Base Installation Kit (715008125) is required for installation.
- See table for installation location and requirements.

NEW LinQ 5.3 US Gal (20 L) Semi-Rigid Cooler

Maverick R, Maverick R MAX

■ 295101252



- 5.3 US gal (20 L) of insulated, water-resistant capacity.
- Quick, easy and secure LinQ system installation.
- Attaches with one set of LinQ fasteners.
- Single-day-use soft cooler.
- Mesh pocket on top of the lid.
- Zippered pocket under the lid for quick and easy access.
- Removable interior for easy cleaning.
- Carry handles for easy transport.
- Can contain twelve 355 ml cans.
- Dimensions: 19" L x 13" W x 10" H.
- See table for installation location and requirements.

LinQ 11.4 US Gal (43 L) Cooler	Maverick R, Maverick R MAX	<ul style="list-style-type: none"> ■ 715007825 - Black ■ 715009276 - Gray
	<ul style="list-style-type: none"> • Versatile LinQ 16" configuration fits many vehicles. • High quality injection-molded impact resistant polypropylene outer shell for exceptional durability. • High quality insulation for optimal ice retention. • Thicker insulation on bottom to isolate vehicle heat. • 11.4 US gal (43 L) capacity. • LinQ-mounted for fast, easy, secure storage. • Locks in place with only a quarter turn. • Rigid handles make transportation easy. • Horizontal locking handles allow installation of LinQ Lite accessories. • Dry-basket included to protect items. • Drain plug at the bottom to evacuate water. • New ergonomic and secure latch system offers excellent sealing. • Possibility to lock the cooler with a padlock. • See table for installation location and requirements. 	
LinQ Modular Box	Maverick R, Maverick R MAX	<ul style="list-style-type: none"> 715005494 - (10 L) 715007112 - (20 L) 715006830 - (30 L)
	<ul style="list-style-type: none"> • Allows stacking of other modular boxes to always have the right gear accessible. • Always have the right box size to fit everything. • Can be installed on any LinQ base with a 16" width. • See table for installation location and requirements. 	
Thermal Insert for LinQ Modular Box (10 L)	Maverick R, Maverick R MAX	219401110
	<ul style="list-style-type: none"> • Insulated liner. • Fits very well in the LinQ Modular Box (10 L). • Can contain seven 355 ml cans. • Keeps ice cold for one day. • Interior dimensions: 9" L x 17" W x 2½" H. 	
LinQ Tool Box	Maverick R, Maverick R MAX	715008111
	<ul style="list-style-type: none"> • High precision injected HDPE construction provides rigidity and durability. • 5 gal (19 L) maximum capacity. • Weather-resistant, sealed and lockable cover. • Easy one-second on/off tool-less system. • All the benefits of LinQ—simple, fast and secure. • See table for installation location and requirements. 	
LinQ Tool Kit	Maverick R, Maverick R MAX	715006829
	<ul style="list-style-type: none"> • Includes: <ul style="list-style-type: none"> - Cutter pliers - Long-nose pliers - Locking pliers - Ratchet wrench ¾" drive - 6" ratchet extension - Integrated CVT belt storage location (belt not included) - Long-socket 19 mm ¾" drive – 6 pts - Socket 18 mm ¾" drive - Long-socket 17 mm ¾" drive – 6 pts - Socket 15 mm ¾" drive - Socket 13 mm ¾" drive - Socket 10 mm ¾" drive - Socket 8 mm ¾" drive - Socket Torx T40 ¾" drive - Socket Torx T30 ¾" drive - Socket Torx T20 ¾" drive - Breaker bar ¾" drive • Combination Wrench set: <ul style="list-style-type: none"> - Wrench 13 mm - Wrench 10 mm - Wrench 8 mm - Wrench 19 mm - Wrench 18 mm - Wrench 15 mm • See table for installation location and requirements. 	
LinQ 4.5 Gal (17 L) Sport Bag	Maverick R, Maverick R MAX	860202447
	<ul style="list-style-type: none"> • All the benefits of LinQ—simple, fast and secure. • 17 liter (4.5 US gallon) capacity. • Thermoformed bag base in HDPE (High Density Polyethylene) providing rigidity and durability. • Rigid bottom, semi-rigid top. • Easy one-second on/off tool-less system. • See table for installation location and requirements. 	
SR 5.5 Gal (21 L) LinQ Bag	Maverick R, Maverick R MAX	860202449
	<ul style="list-style-type: none"> • All the benefits of LinQ—simple, fast and secure. • Semi-rigid expandable bag. • 5.5 gal (21 L) capacity. • Utilizes LinQ mounting system (Patent US 8777531 and US 8875830). • Easy one-second on/off tool-less system. • See table for installation location and requirements. 	

LinQ Roll-Top Bag	Maverick R, Maverick R MAX	715008110
--------------------------	----------------------------	------------------



- Fully waterproof roll-top dry bag will securely store and confine your equipment.
- LinQ mounted using heavy-duty rigid plastic base.
- High capacity storage solution (40 L).
- Bottom foam liner for additional equipment protection.
- Integrated handle for easy transportation on/off the vehicle.
- Dimensions: 14" L x 19" W x adjustable H.
- See table for installation location and requirements.

LinQ Explorer Bag	Maverick R, Maverick R MAX	295101016
--------------------------	----------------------------	------------------



- 26 gal (100 L) of watertight storage.
- Installs in seconds with tool-less LinQ accessory system.
- Dedicated essentials compartment for registration, license, insurance and more.
- Exclusive D.E.S.S.™ key storage.
- External quick-access pocket for small items like keys and wallets.
- Turns into a backpack when you get off your machine.
- Collapsible if not fully packed with straps on both sides.
- Dimensions: 26" L x 18" W x 14" H.

LinQ ACCESSORIES WITH 36" BASE

LinQ Trunk Box (87 L) – G3L	Maverick R, Maverick R MAX	715009312
------------------------------------	----------------------------	------------------



- Weatherproof polyethylene rear cargo box compatible on the rear rack.
- Storage capacity of 23 gal (87 L).
- Optimized shape of the cargo box base to fit the G3L rear rack perfectly.
- Lockable with a lock on the front of the box (2 keys included).
- Easy to install, easy to remove using the LinQ system.
- Installation in LinQ 36" configuration.
- Requires the installation of the Stopper Kit 715008895 included with the accessory.
- See table for installation location and requirements.

LinQ 9.2 Gal (35 L) Cooler	Maverick R, Maverick R MAX	715006998
-----------------------------------	----------------------------	------------------



- LinQ-mounted for efficient and secure storage, locked in place with only a quarter turn.
- Easy to install, easy to remove using the LinQ system.
- Installation in LinQ 36" configuration.
- Made of polyethylene for exceptional rigidity and durability.
- Storage capacity of 35 L.
- Lock the cooler on the vehicle using the LinQ Lock (860201968).
- Premium-quality foam insulation for optimal ice retention.
- Option to add a 5-slot LinQ Lite Rail on the side and at the rear of the cooler.
- A dry basket is included to protect your food from water.
- Drain plug at the bottom to get rid of excess water.
- The new ergonomic and resistant latch system ensures the top is tightly sealed.
- Innovative way to hold 12 cans (355 ml).
- Molded-in handles for quick installation and removal.
- See table for installation location and requirements.

LinQ Cargo Box (53 L)	Maverick R, Maverick R MAX	715006997
------------------------------	----------------------------	------------------



- Made of polyethylene.
- Storage capacity of 14 gal (53 L).
- Easy to install and remove with the LinQ system.
- New ergonomic and resistant latch system offers excellent sealing.
- Possibility to install LinQ 16" accessories on the cover and increase the cargo capacity.
- Ability to install Tool Holders (715008896) on the box.
- Lockable with a lock on the front of the box (2 keys included).
- See table for installation location and requirements.

LinQ Low Profile Box (63 L)	Maverick R, Maverick R MAX	715007827
------------------------------------	----------------------------	------------------



- Made of impact-resistant injected polypropylene and weatherproof, this box has a storage capacity of 63 L.
- LinQ-mounted for efficient and secure storage, it is locked in place with only a quarter turn. Easy to install, easy to remove using the LinQ system.
- Can be installed in several 16" configurations, or in a 36" configuration.
- LinQ 16" accessories can be installed on the cover to increase cargo capacity.
- Easily carried with the rigid handle. The anti-vibration system prevents the handle from moving while riding.
- Support feet at hinge level so the box can stand on its own.
- The compact design allows for maximum rear field of vision.
- Features a lock on the front of the box (two keys included).
- See table for installation location and requirements.

LinQ Cargo Basket (90 L)	Maverick R, Maverick R MAX	715005274
---------------------------------	----------------------------	------------------



- Made of polyethylene.
- Storage capacity of 23 gal (90 L).
- Easy to install and remove with the LinQ system.
- Can already be installed on your vehicle thanks to the stock mounted LinQ anchor.
- 6 handles on the contour to easily install bungee cords.
- Ability to install Tool Holders (715008896) on the basket.
- See table for installation location and requirements.

LinQ CARGO ACCESSORIES

LinQ Trunk Box (96 L)

Maverick R, Maverick R MAX

715007182



- Weatherproof box made of impact-resistant injected polypropylene reinforced with glass fiber.
- Features a maximum storage capacity of 96 L and 15 kg.
- Easy to install, easy to remove with the LinQ system.
- Can already be installed on your vehicle thanks to the stock mounted LinQ anchor.
- Ability to install in conjunction with the LinQ Side Cargo Boxes (13.5 L) for a complete cargo solution.
- Not compatible with LinQ Pivoting Rack (715009465) and Adventure Roof Rack (715007186).
- See table for installation location and requirements.

LinQ Side Cargo Boxes (13.5 L)

Maverick R, Maverick R MAX

715007372



- Weatherproof box made of impact-resistant injected polypropylene reinforced with glass fiber.
- Features a maximum storage capacity of 13.5 L each and 5 kg.
- Easy to install, easy to remove thanks to the LinQ system.
- Possibility of installing up to two LinQ 16" accessories between the LinQ Side Cargo Boxes (13.5 L).
- Ability to install in conjunction with the LinQ Trunk Box (96 L) for a complete cargo solution.
- Not compatible with LinQ Pivoting Rack (715009465) and Adventure Roof Rack (715007186).
- See table for installation location and requirements.

LinQ HOLDERS

NEW LinQ Lite Action Camera Holder

Maverick R, Maverick R MAX

295101139



- LinQ Lite attachment system for cameras.
- Provides great vantage points to capture photos and videos.
- Offers 360-angle positioning for perfect filming and taking photos.
- Designed to hold devices securely.
- Fast, easy attachment and removal.

NEW LinQ Lite Device Holder

Maverick R, Maverick R MAX

715009201



- Made with strong magnets that you can trust while riding through rough terrain.
- Includes everything needed for installation on your favorite electronic devices: 2 pre-assembled Can-Am plates with 3M multi-surface adhesive.
- 360° adjustment for an improved driving experience and immersion.
- Secure LinQ Lite attachment allows you to install/remove the holder in seconds.
- Robust plastic and aluminum construction allows for the right fit and easy installation.
- Compatible with the Cellphone Holder (715008786).
- To keep a good vision while driving, we recommend using this device for smartphones only.

LinQ Tool Holder

Maverick R, Maverick R MAX

715007358



- Ultra-versatile tool holder.
- Convenient swivel-latch allows tools to be stored in any orientation.
- Sold in pairs.

LinQ Gear Grips

Maverick R, Maverick R MAX

715005340



- Durable and flexible grips provide a custom fit for a variety of items from 1" to 4" (2.5 cm to 10 cm) in diameter.
- Heavy-duty design for carrying bows, fishing poles, rakes, farm tools and more.
- Quick-release button opens grip quickly for easy access to gear.
- Heavy-duty base system built for the toughest adventures.
- Make transporting your tools a snap by combining the LinQ Gear Grips with the LinQ system.
- 360° orientation.
- Sold in pairs.

LinQ MOUNTING

LinQ Adapter

Maverick R, Maverick R MAX

715003058



- Sold in pack of 4.
- Allows the installation of the LinQ Tool Holder on the Adventure Roof Rack.

LinQ Base Installation Kit	Maverick R, Maverick R MAX	715008125
-----------------------------------	----------------------------	------------------

- Unique mounting fastener usable on any LinQ system accessory.
- Included: 2 cargo LinQ bases and hardware.



LinQ Lock	Maverick R, Maverick R MAX	860201968
------------------	----------------------------	------------------

- Simple way to securely lock most LinQ accessories.
- Lock cover protects lock from the elements.
- Corrosion resistant.
- Pack of 1, includes 2 keys.
- Not compatible with LinQ 4.2 US Gal (16 L) Cooler, LinQ Tool Box, LinQ Tool Holder or LinQ Gear Grips.



Spare Tire Ratchet Tie-Downs	Maverick R, Maverick R MAX	280000955
-------------------------------------	----------------------------	------------------

- 3-way ratcheting tie-down strap with loop ends.
- Designed to securely hold spare tires on accessories equipped with integrated spare tire attachment points.
- Adjustable to accommodate most common UTV tire sizes.
- Ratchet and junction ring made of durable zinc-plated steel.
- Required for spare tire attachment on Adventure Roof Rack.



RACKS & STORAGE

RACKS

LinQ Pivoting Rack	Maverick R, Maverick R MAX	715009465
---------------------------	----------------------------	------------------

- Strong and durable, the LinQ Pivoting Rack helps keep cargo securely in place.
- Anti-corrosion coating with durable powder coat finish.
- Gas cylinder pivot action, locks in the open position.
- Possibility of installing up to three LinQ 16" accessories on top of the rack.
- Compatible with LinQ accessories for installation under the rack.
- Features anchor points for the spare-tire attachment.
- Spare Tire Tie-Downs sold separately.



Adventure Roof Rack	Maverick R	715007186
	Maverick R MAX	715008073

- The ideal cargo solution. Pack all the gear you need to take on any off-road experience.
- Built using lightweight 1.25" (3,2 cm) diameter steel tubing.
- Supports loads of up to 75 lb (34 kg).
- This roof rack features a height adjustment setting to precisely accommodate a stock roof or a roof with Cold Air Roof Scoop.
- Integrated mounting points for lights.
- Features anchor points for a spare tire attachment.
- Can be completed with LinQ Adapter (715003058) on the side.
- The Spare Tire Tie-Downs sold separately.
- Sport Roof (715008074) is required for installation on Maverick R MAX.



STORAGE

Center Console Bag	Maverick R MAX	715007895
---------------------------	----------------	------------------

- These weather-resistant bags hold your gear safely and securely while you ride.
- Extra storage solution for front and rear passenger.
- Accessible from front and rear seating position.
- Attach the bag between the seats to maximize unused space and increase the vehicle's cargo capacity.
- Volume 23 L.
- Dedicated pocket for goggles.
- Detachable side pouches for additional storage/garbage.
- Clear side pockets for cellphones.



Shoulder Storage Bag

Maverick R, Maverick R MAX

715007371



- This weather-resistant bag holds your gear safely and securely while you ride.
- Attach the bag between the seats to maximize unused space and increase the vehicle's cargo capacity.
- This bag has a 1,5 gal (6 L) capacity and is equipped with outer netting compartments and a flexible inner net to hold items in place.
- The thermoformed base creates a semi-rigid structure to ease installation.
- Its soft construction makes the bag flexible enough to fit odd-shaped loads.

Overhead Storage Bag

Maverick R, Maverick R MAX

715007379



- This weather-resistant bag holds your gear safely and securely while you ride.
- Makes smart use of the overhead space and increases the vehicle's cargo capacity by 2,3 gal (9 L).
- The thermoformed base attaches to the roof for easy bag installation and the soft construction makes the bag flexible enough to fit oddly shaped loads.
- Features a hanging function for easier access to the items in the bag and an integrated net for even more storage space.
- Contains two sections: a fixed bag and a detachable bag that can be carried.
- Easily access your smartphone using the touchscreen-compatible clear front pocket.

Rear Upper Door Storage Bags

Maverick R MAX

715007893



- Weather-resistant bags hold your gear safely and securely while you ride.
- Door bags fit in the upper door opening to increase your vehicle's cargo space.
- Each bag is designed as a 1,3 gal (5 L) capacity pocket and is equipped with inner netting compartments.
- Thermoformed base attaches to the doors, allowing the bags to be installed.
- Its soft construction makes the bag flexible enough to fit odd-shaped loads.
- Added elbow cushions for extra comfort.
- Sold in pairs.

Upper Door Storage Bags

Maverick R, Maverick R MAX

715008065



- These weather-resistant bags hold your gear safely and securely while you ride.
- The door bags fit in the upper door opening to increase your vehicle's cargo space.
- Each bag is designed as a 1,3 gal (5 L) capacity pocket and is equipped with inner netting compartments.
- The thermoformed base attaches to the doors, allowing the bags to be installed.
- Its soft construction makes the bag flexible enough to fit odd-shaped loads.
- Added elbow cushions for extra comfort.
- Sold in pairs.

Lower Door Storage Bags

Maverick R, Maverick R MAX

715007324



- These weather-resistant bags hold your gear safely and securely while you ride.
- The door bags fit in the lower door opening to increase the vehicle's cargo space.
- Each bag is designed as a 1,3 gal (5 L) capacity pocket and equipped with inner netting compartments.
- The thermoformed base attaches to the doors, allowing the bags to be installed.
- Its soft construction makes the bag flexible enough to fit odd-shaped loads.
- Added cushions for extra comfort.
- Sold in pairs.
- Not compatible with Door Speakers (Level 5 Audio System).

Passenger Storage Seat Bag

Maverick R, Maverick R MAX

715008080



- This weather-resistant bag holds your gear safely and securely while you ride.
- Bag settling on the passenger's seat to increase the vehicle's cargo capacity.
- This bag features a 14,5 gal (55 L) storage capacity and is divided into two compartments.
- The top compartment is insulated to keep your beverages cold and includes two cup holders.
- Additional pocket inside for additional storage, such as a cell phone.
- The bottom compartment is accessible from both sides and serves as a large pocket for storing various items.
- The detachable pocket at the front of the bag can be used as a garbage bag.

Back Panel Storage Net

Maverick R, Maverick R MAX

715008312



- Storage net behind the passenger's seat for more storage.

Bed Side Doors

Maverick R, Maverick R MAX

715009154



- Creates a storage solution out of the rear bed cavities of the unit.
- Perfect for housing trail and safety items that remain on the vehicle.
- Includes two Bed Side Doors, one for each side.



SMART ACCESSORIES

Powered by the ACM, SMART Accessories respond automatically to speed, steering, and other sensor data, adjusting light output, behavior, and function in real time.

A RESPONSE SYSTEM THAT TAKES TECH TO THE NEXT LEVEL.

ACM

This is the brain of the SMART Ecosystem. It reads multiple sensors on the vehicle and translates the reading into actions for the accessories.



10.25" TOUCHSCREEN DISPLAY

When your vehicle is equipped with the 10.25" touchscreen display, it allows you to control up to 19 accessories at the same time.



SMART CONTROL CENTER

Allows you to quickly access SMART Accessories (can be used with or without the 10.25" touchscreen display).



SMART ACCESSORIES

Accessories designed to execute multiple functions depending on the input from the ACM.



ACM & SMART ACCESSORIES

ACCESSORY CONTROL MODULE (ACM)

Accessory Control Module

Maverick R, Maverick R MAX
(except X rc models)

715010097



- Bringing the SMART to accessories using live vehicle ECU information to maximize your accessory experience.
- Connect your accessories to the 10.25" Color Touchscreen Display.
- Easy accessory installation (plug and play).
- Creates an ecosystem that makes installing accessories quicker and easier.
- Includes ACM Front Harness to connect front-mounted SMART accessories to the Accessory Control Module (two auxiliary connectors available).
- Requires ACM Rear Harness (715009268) to connect rear-mounted SMART accessories to the Accessory Control Module.

Rear ACM Harness

(Not illustrated)

Maverick R, Maverick R MAX

715009268

- Required to connect rear-mounted accessories and rear chase lights to the ACM.
- Creates an ecosystem that makes installing accessories quicker and easier.
- Five auxiliary connectors are available.

NEW X rc Roof Harness

Maverick R, Maverick R MAX
(X rc models only)

715010620



- Electric harness required to hook up and operate Roof Lights with ACM.
- Required only for Maverick R X rc.

SMART Control Center for ACM

Maverick R, Maverick R MAX

715010834



- Control accessories with the selection of different modes, the illuminated halo around the button indicates the active mode.
- Icons illuminate when accessories are activated.
- Make accessory control changes without having to take your eyes off the trail by choosing the accessory button required (quick access).
- All Front LED Off button to turn off all front lights with one click. Remembers the last programmed setups when this button is pressed again.
- 6 pre-programmed buttons (Light Bars, PowerFlip Windshield, All Front LED Off, Corner Lights) and 10 programmable buttons to customize according to the accessories installed.
- Requires Accessory Control Module.

SMART ACCESSORIES

NEW SMART 10" (25 cm) LED Light Bar

Maverick R, Maverick R MAX

715008745



- The perfect combination of powerful white and selective yellow LEDs.
- The selective yellow LEDs are ideal for driving in low visibility conditions.
- The light is composed of 16 white LEDs and 8 yellow LEDs.
- Spot and Flood combo beam.
- The side lens design provides highly effective wide-angle illumination.
- The white LEDs produce 8,100 raw lumens and the selective yellow 2,640 raw lumens, delivering stunning lighting performance.
- The lens is made from hard-coated polycarbonate.
- IP67 and IP69k submersible and pressure washer safe.
- Switch options: Off, Low and High. Color change by flicking the switch quickly.
- SMART options: Off, Low, High, color change and SMART Automatic Mode.
- SMART MODE: Intensity increase or decreases and Spot/Flood ratio varies according to the speed of the vehicle with the installation of the Accessory Control Module (ACM).
- Accessory Control Module (715010097) is required for SMART functionality.
- Wiring Harness (715009886) is required for on/off function when ACM is not installed. Sold separately.
- See table for installation and requirements.
- ECE Certified

NEW SMART 40" (102 cm) LED Light Bar

Maverick R, Maverick R MAX

715008747

- The perfect combination of powerful white or selective yellow LEDs.
- The selective yellow LEDs are ideal for driving in low visibility conditions.
- The light is composed of 64 white LEDs and 32 yellow LEDs.
- Spot and Flood combo beam.
- The side lens design provides highly effective wide-angle illumination.
- The white LEDs produce 32,000 raw lumens and the selective yellow 10,560 raw lumens, delivering stunning lighting performance.
- The lens is made from hard-coated polycarbonate.
- IP67 and IP69k submersible and pressure washer safe.
- Switch options: Off, Low and High. Color change by flicking the switch quickly.
- SMART options: Off, Low, High, color change and SMART Automatic Mode.
- SMART MODE: Intensity increases or decreases and Spot/Flood ratio varies according to the speed of the vehicle with the installation of the Accessory Control Module (ACM).
- Accessory Control Module (715010097 or 715010620) is required for SMART functionality
- Requires LED Light Bar Mounts (715003529) or mounts directly to some Can-Am audio roofs.
- See table for installation location and requirements.
- ECE Certified

SMART Particle Separator

Maverick R, Maverick R MAX

715007187

- Filters up to 96% of the dust prior to air intake.
- Fan speed adjusts with vehicle speed/RPM when equipped with ACM (Accessory Control Module).
- Mounts directly to the stock air intake duct.
- Air intake tube (706600403) is currently required for installation.
- IP68 fan.
- Requires Particle Separator Harness (715008890) when not equipped with the ACM.
- Keeps your air filter clean longer.
- Maintains engine performance.

SMART Integrated LED Roof Light

Maverick R, Maverick R MAX

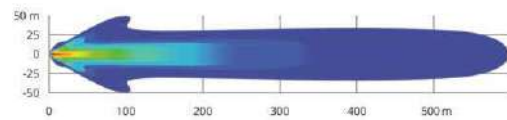
715007322**22,100 lumens**

- Mounted under the roof for a signature look.
- Windshield compatible except PowerFlip Windshield (715009900).
- Intensity varies (increases or decreases) according to the speed of the vehicle with the installation of the Accessory Control Module (ACM) (Spot/Flood ratio).
- Spot/Flood combo beam.
- 22,100 lumens.
- Off/Low/High (switch activated).
- Off/Low/High/SMART Automatic Mode (Accessory Control Module (ACM) activated).
- Accessory Control Module (715010097 or 715010620) is required for SMART functionality.
- Electric Harness (715008209) required to hook up and operate the Integrated LED Roof Light (715007322) for on/off function when ACM is not installed. Sold separately.
- ECE Certified

SMART Integrated LED Hood Light

Maverick R, Maverick R MAX

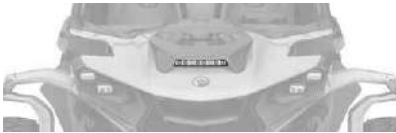
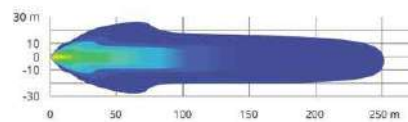
715007378**5,250 lumens**

- Mounted flush inside the hood scoop for a signature look.
- Intensity varies (increases or decreases) according to the speed of the vehicle with the installation of the Accessory Control Module (ACM) (Spot/Flood ratio).
- Spot/Flood combo beam.
- 5,250 lumens.
- Off/Low/High (switch activated).
- Off/Low/High/SMART Automatic Mode (Accessory Control Module (ACM) activated).
- Accessory Control Module (715010097) is required for SMART functionality.
- Wiring Harness (715008211) required for on/off function when ACM is not installed. Sold separately.
- ECE Certified

SMART Integrated LED Side Mirror Lights

Maverick R, Maverick R MAX

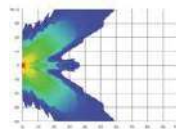
715007185**3,000 lumens**

- Light up corners.
- Increase the width of the beams and illuminate the wheels for increased visibility.
- Wide flood beam.
- 3,000 lumens for each light.
- Left and right dynamic lighting with Accessory Control Module (ACM) install. Follow steering wheel input.
- Accessory Control Module (715010097) is required for SMART functionality.
- Require Aluminum Side Mirrors (715007363).
- Electric Harness required (715008212) to hook up and operate the Integrated LED Side Mirror Lights for on/off function when ACM is not installed. Sold separately.

SMART LED Chase Lights

Maverick R, Maverick R MAX

715007727



- Designed by Can-Am to make you visible to vehicles riding behind you, especially in dusty or harsh conditions.
- Four modes available:
 - Trail Mode: serves as a taillight and as a brake light.
 - Chasing Mode: displays amber light pattern and serves as a brake light.
 - Work Mode: white light to light up your cargo bed.
 - Reverse Mode (when connected with Accessory Control Module (ACM)): serves as a back up light.
- Modular to allow installation with rear roll cage mounted accessories.
- Plug-and-play installation with the Accessory Control Module (ACM).
- Accessory Control Module (715010097) and Rear ACM Harness (715009268) are required for SMART functionality.
- Electric Harness (715008210) required to hook up and operate the LED Chase Lights (715007727) for a non-smart function when ACM is not installed.
- The Cold Air Roof Scoop limits the performance of the Chase Lights to only the two outside portions and not the center.
- ECE Certified

SMART PowerFlip Intermittent Windshield Wiper & Washer Kit

Maverick R, Maverick R MAX

715008555



- Washer fluid dispenser is perfectly concealed on the vehicle.
- Must be installed with the PowerFlip Windshield (sold separately).
- SMART and fixed intermittence wiper speed feature available when the kit is installed in combination with ACM.
- Electric Harness required (715008855) to hook up and operate the Wiper & Washer Kits when ACM is not installed (sold separately).

SMART Intermittent Wiper & Washer Kit

Maverick R, Maverick R MAX

715007173



- An ideal way to keep your windshield clear in the rain, or while riding through mud and water.
- The wiper mechanism and washer fluid dispenser are perfectly concealed on the vehicle.
- The wiper and washer fluid dispenser installs at the bottom of the windscreen for maximum visibility.
- For use on glass or hardcoated windshields.
- SMART and fixed intermittence wiper speed feature available when the kit is installed in combination with ACM.
- Electric Harness (715008855) required to hook up and operate the Wiper & Washer Kit (715007173) for on/off function when ACM is not installed.

LIGHTS

CAN-AM LIGHTS

CAN-AM LIGHTS WITH ACM

		2 CHOOSE YOUR LIGHTS					
1 CHOOSE YOUR MOUNT POINT		SMART Integrated LED Roof Light 715007322	SMART Integrated LED Hood Light 715007378	SMART Integrated LED Side Mirror Lights 715007185	SMART LED Chase Lights 715007727	SMART 40" (102 cm) LED Light Bar 715008747	SMART 10" (25 cm) LED Light Bar 715008745
SMART FUNCTIONALITY	Vehicle Integrated	Accessory Control Module 715010097 or X rc Roof Harness 715010620 (X rc models only)	Accessory Control Module 715010097	Aluminum Side Mirrors 715007363 + Accessory Control Module 715010097	Accessory Control Module 715010097 + Rear ACM Harness 715009268	No compatibility	
	Desert Front Bumper (715007311, 715007691 or 715009926)	No compatibility	No compatibility	No compatibility	No compatibility	No compatibility	Accessory Control Module 715010097 *Not compatible with Accessory Control Module 715009796
	Trail Front Bumper (715010071, 715010072 or 715009925)					No compatibility	
	Sport Roof with Light Support Bar (715003529)					Accessory Control Module 715010097 or X rc Roof Harness 715010620 (X rc models only) *Not compatible with Accessory Control Module 715009796	No compatibility
	Audio Roof (no additional bracket needed)						
	Adventure Roof Rack (715007186, 715008073)						

CAN-AM LIGHTS WITHOUT ACM

		2 CHOOSE YOUR LIGHTS					
1 CHOOSE YOUR MOUNT POINT		SMART Integrated LED Roof Light 715007322	SMART Integrated LED Hood Light 715007378	SMART Integrated LED Side Mirror Lights 715007185	SMART LED Chase Lights 715007727	SMART 40" (102 cm) LED Light Bar 715008747	SMART 10" (25 cm) LED Light Bar 715008745
ON/OFF FUNCTIONALITY	Vehicle Integrated	Integrated LED Roof Light Wiring Harness 715008209	Integrated LED Hood Light Wiring Harness 715008211	Aluminum Side Mirrors 715007363 + Integrated LED Side Mirror Lights Wiring Harness 715008212	LED Chase Lights Wiring Harness 715008210	No compatibility	
	Desert Front Bumper (715007311, 715007691 or 715009926)	No compatibility	No compatibility	No compatibility	No compatibility	Lights Wiring Harness 715009886	
	Trail Front Bumper (715010071, 715010072 or 715009925)						No compatibility
	Sport Roof with Light Support Bar (715003529)						
	Audio Toof (no additional bracket needed)						
	Adventure Roof Rack (715007186, 715008073)						

*All lights are intended for off-road use only.

BAJA LIGHTS

BAJA LIGHTS WITH ACM

1 CHOOSE YOUR MOUNT POINT	2 CHOOSE YOUR LIGHTS				
	40" (102 cm) Baja Designs OnX6 Arc LED Light Bar 710006818	10" (25 cm) Baja Designs OnX6 LED Light Bar 710006819	Baja Designs XL Sport LED Lights 710006821	Baja Designs Squadron Sport LED Lights 710006820	Baja Designs XL80 LED Lights 710005041
Front Bumper X rc (71501008)	No compatibility	Front Bumper X rc Light Support 715010532 + LED Light Bars ACM Adaptor 715008213	Front Bumper X rc Light Support 715010532 + LED Lights ACM Adaptor 715007715		
Desert Front Bumper (715007311, 715007691 or 715009926)		LED Light Bars ACM Adaptor 715008213	LED Lights ACM Adaptor 715007715		
Trail Front Bumper (715010071, 715010072 or 715009925)		No compatibility	LED Lights ACM Adaptor 715007715 + X rc Roof Harness 715010620 (X rc models only)		
Roof with Light Support Bar (715003529)			No compatibility		
Roof Light Mounting Kit – Low Position (715008585)	LED Light Bars ACM Adaptor 715008213 + X rc Roof Harness 715010620 (X rc models only)	No compatibility			
Roof Light Mounting Kit – High Position (715007930)					

*All Baja Lights are not ACM compatible with Maverick R X rc models

BAJA LIGHTS WITHOUT ACM

1 CHOOSE YOUR MOUNT POINT	2 CHOOSE YOUR LIGHTS				
	40" (102 cm) Baja Designs OnX6 Arc LED Light Bar 710006818	10" (25 cm) Baja Designs OnX6 LED Light Bar 710006819	Baja Designs XL Sport LED Lights 710006821	Baja Designs Squadron Sport LED Lights 710006820	Baja Designs XL80 LED Lights 710005041
Front Bumper X rc (71501008)	No compatibility	Front Bumper X rc Light Support 715010532 + Wiring Harness 715008863	Front Bumper X rc Light Support 715010532 + Wiring Harness 715008865		Front Bumper X rc Light Support 715010532 + Wiring Harness 715008863
Desert Front Bumper (715007311, 715007691 or 715009926)		Wiring Harness 715008863	Wiring Harness 715008865	Wiring Harness 715008865	Wiring Harness 715008863
Trail Front Bumper (715010071, 715010072 or 715009925)					
Roof with Light Support Bar (715003529)					
Roof Light Mounting Kit – Low Position (715008585)	Wiring Harness 715008864	No compatibility			
Roof Light Mounting Kit – High Position (715007930)					

4 ORDER **ORDER ALL PART NUMBERS IN INTERSECTING BOX**
*Note: When installing more than one light kit, additional light power cable or mounting kit is required.

*All lights are intended for off-road use only.

40" (102 cm) Baja Designs OnX6 Arc LED Light Bar

Maverick R, Maverick R MAX

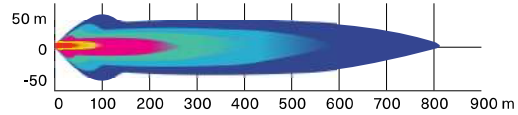
710006818**29,000 lumens**

- 252 W light bar producing 29,000 lumens.
- Equipped with 24 Cree XM-L2 LEDs.
- Driving/Combo light pattern for smooth blend of light for both near field applications and distance.
- Designed for installation onto Light Support Bar equipped roofs.
- Requires Light Power Cable and Light Support Bar.

- ACM Adaptor required (715008213) to connect the Baja Designs LED Light Bars to the ACM harness.
- Electric Harness (715008864) required to hook up and operate the 40" (102 cm) Baja Designs OnX6 Arc LED Light Bar (710006818) for on/off function when ACM is not installed.
- Baja Designs Light Mounting Kit (715007930 or 715008585) is required for installation.
- See table for installation location and requirements.

Baja Designs 10" (25 cm) OnX6 LED Light Bar

Maverick R, Maverick R MAX

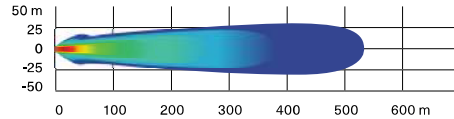
710006819**12,460 lumens**

- 108 W light bar producing 12,460 lumens.
- Equipped with 6 Cree XM-L2 LEDs.
- Driving/combo light pattern for smooth blend of light for both near field applications and distance.
- Dual intensity (high/low) settings.

- Requires Baja Designs Light Power Cable.
- ACM Adaptor required (715008213) to connect the Baja Designs LED Light Bars to the ACM harness.
- Electric Harness (715008863) required to hook up and operate the 10" (25 cm) Baja Designs OnX6 LED Light Bar (710006819) for on/off function when ACM is not installed.
- See table for installation location and requirements.

Baja Designs XL80 LED Lights

Maverick R, Maverick R MAX

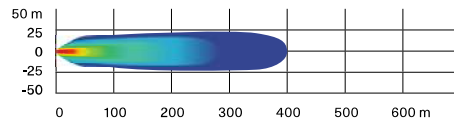
710005041**9,500 lumens**

- 80 W per spot producing 9,500 lumens.
- Equipped with 4 Cree XHP50 LEDs per spot.
- Dual intensity (high/low) settings.
- Driving/combo light pattern for smooth blend of light for both near field applications and distance.
- Require Baja Designs Light Power Cable.
- Sold in pairs.

- Dimensions: 4.5" x 4.5" (11.4 cm x 11.4 cm).
- ACM Adaptor required (715007715) to connect the Baja Designs LED Lights to the ACM harness.
- Electric Harness (715008863) required to hook up and operate the Baja Designs XL80 LED Lights (710005041) for on/off function when ACM is not installed.
- See table for installation location and requirements.

Baja Designs Squadron Sport LED Lights

Maverick R, Maverick R MAX

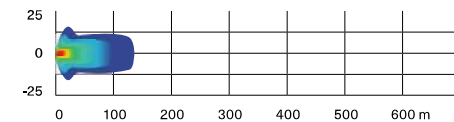
710006820**3,150 lumens**

- 26 W per spot producing 3,150 lumens.
- Equipped with 4 Cree XP-G2 LEDs per spot.
- Wide cornering light pattern designed specifically for cornering, dust and/or fog conditions.
- Sold in pairs.

- Dimensions: 3" x 3" (7.6 cm x 7.6 cm).
- Electric Harness (715008865) required to hook up and operate the Baja Designs Squadron Sport LED Lights (710006820) for on/off function when ACM is not installed.
- See table for installation location and requirements.

Baja Designs XL Sport LED Lights

Maverick R, Maverick R MAX

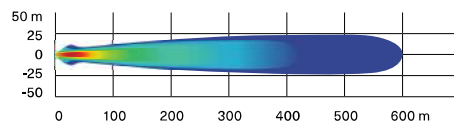
710006821**3,150 lumens**

- 26 W per spot producing 3,150 lumens.
- Equipped with 4 Cree XP-G2 LEDs per spot.
- High Speed Spot features a longer and narrower beam focus for illumination farther down.
- Require Baja Designs Light Power Cable.
- Sold in pairs.

- Dimensions: 4.5" x 4.5" (11.4 cm x 11.4 cm).
- ACM Adaptor required (715007715) to connect the Baja Designs LED Lights to the ACM harness.
- Electric Harness (715008865) required to hook up and operate the Baja Designs XL Sport LED Lights (710006821) for on/off function when ACM is not installed.
- See table for installation location and requirements.

NEW Dome Light

Maverick R, Maverick R MAX

715009228

- Offers an optimal visibility in the cab and integrates perfectly with the vehicle.
- 160 lumens of soft white light ensure clear visibility of the surroundings.
- Built-in on/off button on the light.
- Wiring included.
- Can be installed on cage or Sport Roof.
- Not compatible with Audio Roof.

NEW Front Bumper X rc Light Support

Maverick R, Maverick R MAX

715010532

- Required for lights on Front Bumper X rc (715010008).
- Baja Design lights not compatible with the front bumper and ACM connector on X rc models.

Baja Designs Light Mounting Kit – High Position

Maverick R, Maverick R MAX

715007930

- Mounting system for 40" (102 cm) Baja Designs OnX6 Arc LED Light Bar.
- Compatible with the Cold Air Roof Scoop.

Baja Designs Light Mounting Kit – Low Position

Maverick R, Maverick R MAX

715008585

- Mounting system for 40" (102 cm) Baja Designs OnX6 Arc LED Light Bar.
- Not compatible with the Cold Air Roof Scoop.

NEW Lights Wiring Harness

Maverick R, Maverick R MAX

715009886

- Power cable for installation of the SMART 10" (25 cm) LED Light Bar (715008745).



Rugged on the trails doesn't mean giving up the finer things. Treat yourself to exceptional sound on the move. Expertly tuned and DSP-calibrated, Can-Am's JL Audio-powered systems deliver precise equalization, time alignment, crossover filtering, bass boost, and more.

YOUR SOUND, YOUR WAY

Choose the audio setup that matches your style.



LEVEL 3

This option includes four 6.5" (165 mm) speakers (two dash and two surround speakers) PLUS a 10" under-seat 250-watt amplifier



LEVEL 4

This option includes a full roof with a premium JL Audio system including four or six 7.7" coaxial speakers and a 500-watt amplifier



LEVEL 5

This option includes six 6.5" (165 mm) speakers (two dash, two door, and two surround speakers) PLUS two 10" under-seat 250-watt amplifiers

LEVEL UP WITH UPGRADES

Bring the thunder wherever you roll with an amplifier, rear speakers, or a subwoofer for even bigger sound on every ride.

AUDIO SYSTEMS

Can-Am JL Audio System – Level 5

Maverick R, Maverick R MAX

715007957



- Orchestrated for outstanding sound quality and calibrated to enhance your audio experience.
- Designed to fit the vehicle perfectly for a fully integrated look.
- Designed to be Can-Am tough in the most demanding riding conditions.
- Controlled by the 10.25" Color Touchscreen Display or by the Can-Am JL Audio Source Unit.
- Made using premium JL Audio components, including six 6.5" (165 mm) speakers (two dash, two door, and two surround speakers), as well as two 10" (254 mm) under-seat 250 W subwoofers that will enhance both the driver's and the passenger's experience.
- Speakers include an adjustable RGB LED cone illumination.
- Uses one MX500/4 to power up our six speakers, and one MX500/1 to feed the under-seat subwoofers.
- Complements the Can-Am Audio Roof – Level 4 (715007309).

Can-Am JL Audio Roof – Level 4

Maverick R

715007309

Maverick R MAX

715007967



- Full roof with premium JL Audio System for Maverick R.
- Features fully sealed and waterproof components and construction.
- Easy to install and connect.
- Controlled by the 10.25" Color Touchscreen Display or by the Can-Am JL Audio Source Unit.
- Its weatherproof components include four 7.7" coaxial speakers (6 speakers for MAX) and a 500-watt amplifier.
- The system is expertly tuned for exceptional sound when you're riding in your Maverick R.
- Speakers include an adjustable RGB LED cone illumination, controlled via an app on your smartphone.
- When combined with the Can-Am Audio System – Level 3 (715007954) or Level 5 (715007957), it provides the ultimate sound experience.
- Not compatible with the Adventure Roof Rack (715008073 or 715007186).

Can-Am JL Audio System – Level 3

Maverick R, Maverick R MAX

715007954



- Orchestrated for outstanding sound quality and calibrated to enhance your audio experience.
- Designed to fit the vehicle perfectly for a fully integrated look.
- Designed to be Can-Am tough in the most demanding riding conditions.
- Controlled by the 10.25" Color Touchscreen Display or by the Can-Am JL Audio Source Unit.
- Made using premium JL Audio components, including four 6.5" (165 mm) speakers (two dash and two surround speakers), and a 10" (254 mm) under-seat 250 W subwoofer that will enhance both the driver's and the passenger's experience.
- Uses one MX280/4 to power up our four speakers, and one MX500/1 to power up the under-seat subwoofer.
- Easy to install, with the option to add a second subwoofer (715007310).
- Complements the Can-Am Audio Roof – Level 4 (715007309).

Can-Am JL Audio Roof Flip Kit

Maverick R, Maverick R MAX

715008164



- Combines with the Can-Am JL Audio Roof – Level 4 (715007309 or 715007967) for Flip option.
- Not compatible with the Cold Air Roof Scoop and the Roof Rack.

Can-Am JL Audio Subwoofer

Maverick R, Maverick R MAX

715007310



- Orchestrated for outstanding sound quality and calibrated to enhance your audio experience.
- Designed to be Can-Am tough in the most demanding riding conditions.
- Easy to install, this 10" (254 mm) under-seat 250 W subwoofer enhances both the driver's and the passenger's experience.
- When combined with the Can-Am audio system – Level 3 (715007954) or with the Can-Am Audio Roof – Level 4 (715007309), this premium JL Audio component creates the ultimate sound experience.
- To add one or two subwoofers to the Can-Am JL Audio Roof – Level 4, a Can-Am JL Audio Amplifier (715007714) is required.

Can-Am JL Audio Amplifier

Maverick R, Maverick R MAX

715007714



- Orchestrated for outstanding sound quality and calibrated to enhance your audio experience.
- Designed to fit the vehicle perfectly for a seamless integration.
- Designed to be Can-Am tough in the most demanding riding conditions.
- This MX500/1 is a premium JL Audio component and is used to feed one or two 250 W under-seat subwoofers.
- When combined with the Can-Am Audio Roof – Level 4 (715007309 or 715007967), it creates the ultimate sound experience.
- To add one or two subwoofers to the Can-Am JL Audio Roof – Level 4, this item is required.
- Easy to install, mounting support included.

Can-Am JL Audio Source Unit

Maverick R, Maverick R MAX

715008230

- Required with all Can-Am Audio JL levels installed on vehicles without 10,25" Color Touchscreen Display.
- Designed to fit the vehicle perfectly for a fully integrated look.
- AM/FM/Bluetooth compatible.

ELECTRICAL & ELECTRONIC ACCESSORIES

Electronic Device Holder

Maverick R, Maverick R MAX

715007176

- Increases the storage capacity of the glovebox by 1 gal (4 L), with secure magnetic adjustable support for your electronic device.
- Robust injected fiber-reinforced-polypropylene construction allows for the right fit and easy installation.
- Magnet 10 times stronger than any electronic device's weight, ride through rough terrain confidently.
- 2 possible positions for your electronic device: Portrait & Landscape. Adjustable support with 2 positions: facing the passenger or towards the driver for an improved driving experience and immersion.
- Includes everything needed for installation on your favorite electronic devices: 2 pre-assembled Can-Am plates with 3M multi-surface adhesive.

Cellphone Holder

Maverick R, Maverick R MAX

715008786

- Water resistant door allows for perfect phone positioning.
- Features capacitive and resistive touch screen technology.
- Spring system in back plate automatically adjusts for thickness.
- Fits all cellphones within 7.2" (185 mm) x 3.3" (85 mm) x 0.6" (15 mm) dimensions.
- Works with almost all charger wires.
- Does not include cellphone or charging wires.
- Requires the Electronic Device Holder (715007176) for the Cellphone Holder to be supported.

Color Touchscreen Display Protector

Vehicle equipped with 10,25 in. Color Touchscreen Display

860202680

- Provides additional protection for the digital display 10,25 in, touchscreen.
- Protects from scratches caused by ice, rocks, branches or other small debris.
- Anti-glare treatment to ensure good visibility.
- Includes cleaning tools: wet wipe, dry wipe, dust absorber and soft cloth.

Auxiliary Battery Installation Kit

Maverick R, Maverick R MAX

715007837

- Allows the rider to add a second battery and/or replace the original battery (18 Ah or 30 Ah) for a dual battery setup. Recommended to power auxiliary electrical components such as sound systems or winches.
- Automatic rundown protection.
- Installs behind the seat for easy access.
- Requires the purchase of a second battery and battery hardware (not included and sold separately).
- Equipped with an electronic module that prevents the auxiliary electrical components from draining the original battery.

WINCHES

CAN-AM HD WINCHES

Can-Am HD 4500 Winch

Maverick R, Maverick R MAX

715006416



- Ergonomic clutch handle.
- Rugged all-steel gears and bushings for more torque and durability.
- Automatic 100% load-holding brake.
- Sealed solenoid for all-weather protection.
- Weather sealed corded remote and dash mounted switch.
- Pulling strength capability of 4,500 lb (2,041 kg).
- 43' of 1/8" (13.1 m of 6.3 mm) wire steel cable.
- Heavy-duty 4-way roller fairlead.
- Winch Electrical Harness (715008850), Winch Roller Fairlead Spacer (715008922) and winch compatible front bumper are required.
- CE & UKCA Compliant

Can-Am HD 4500-S Winch

Maverick R, Maverick R MAX

715006417



- Ergonomic clutch handle.
- Rugged all-steel gears and bushings for more torque and durability.
- Automatic 100% load-holding brake.
- Sealed solenoid for all-weather protection.
- Weather-sealed corded remote and dash mounted switch.
- Pulling strength capability of 4,500 lb (2,041 kg).
- 50' of 1/4" (15.2 m of 6,35 mm) synthetic rope.
- Corrosion-proof aluminum Hawse fairlead.
- Winch Electrical Harness (715008850) and winch compatible front bumper are required.
- CE & UKCA Compliant

WINCH ACCESSORIES

NEW Winch Cable Stopper

All Can-Am HD Winches

715009921



- Made of EPDM, a highly durable synthetic rubber.
- The Winch Cable Stopper isn't just for looks. It helps extend the life of the winch, rope, hook, and fairlead.
- In addition, the split design makes it easy to install.

Can-Am HD Hawse Fairlead

Can-Am HD Winch

715006426



- A must when upgrading your winch with a synthetic cable, this corrosion-proof aluminum Hawse fairlead will prevent the cable from snapping in a corner of a roller fairlead and from wearing prematurely due to the rough surface of the worn roller guide.
- Must be used with synthetic cables only.

WARN Hawse Fairlead

WARN Winch

715007785



- Double-powder-coated construction.
- To be used with synthetic winch cables only.

Winch Roller Fairlead Spacer

Maverick R, Maverick R MAX

715008922



- Required when using a Winch and Roller Fairlead with a wire cable.
- Made of aluminum, with an anti-corrosion finish.

Synthetic Winch Cable

Can-Am HD Winch

715006430

WARN Winch

715007783



- 50' of 1/4" (15.2 m of 6,35 mm) synthetic cable for Can-Am HD winches.
- Can-Am HD Hawse Fairlead (715006426) is required when upgrading to a synthetic cable to avoid premature cable damage and wear.
- WARN Hawse Fairlead (715007785) is required when upgrading to a synthetic cable to avoid damage and premature wear of the cable.

Wire Rope Replacement

Can-Am HD Winch

705014978

WARN Winch

715006699



- 43' of 1/8" (14.3 m of 6.3 mm) wire rope for Can-Am HD Winch.
- 55' of 1/4" (16.8 m of 6,35 mm) wire rope for WARN winch kit.
- 4,500 lb (2,041 kg) pulling strength.

Synthetic Cable Extension

715001120



- Lightweight ¼" (6,35 mm) diameter, easy to handle and won't rattle in cargo box.
- Easily attaches to winch cable to provide additional 50' (15,2 m) of distance.
- 4,500 lb (2,041 kg) single line capacity.

Winch Electrical Harness

(Not illustrated)

Maverick R, Maverick R MAX

715008850

- Required for winch installation.

NEW Wireless Winch Remote

With Can-Am HD Winch

715008286



- On/Off and Winch In / Winch Out buttons with LED indicator light.
- Large Winch In / Winch Out buttons for easy activation with gloves.
- Ergonomic remote handle shape with a trigger-like holding protrusion.
- Quick and easy to install, thanks to a wiring harness with an integrated antenna and all necessary mounting hardware.
- Allows you to operate your winch from anywhere within a 50' (15,2 m) radius, increasing your recovery options.
- All components are IP67 sealing rated.
- The remote also floats in case it's dropped during a deep water recovery.
- Dash and handlebar mounting options.
- Compatible with all Can-Am HD winches.

Wired Remote Control

Can-Am HD Winch†

715006504



- This kit allows winch owners to add the hand-held remote to vehicles with a stock winch.
- OEM stock winch is sold separately.
- EC compliant.

† Harness (710001023) is required to use remote control on a vehicle with a factory installed winch.

‡ Remote Control (710007050) and connection socket are included.

PERFORMANCE

SMART Particle Separator

Maverick R, Maverick R MAX

715007187



- Filters up to 96% of the dust prior to air intake.
- Fan speed adjusts with vehicle speed/RPM when equipped with ACM (Accessory Control Module).
- Mounts directly to the stock air intake duct.
- Air Intake Tube (706600403) is currently required for installation.
- IP68 fan.
- Requires Particle Separator Harness (715008890) when not equipped with the ACM.
- Keeps your air filter clean longer.
- Maintains engine performance.

Particle Separator Harness

(Not illustrated)

Maverick R, Maverick R MAX

715008890

- Electric harness required to hook up and operate the Engine Air Intake Particle Separator (715007187) for on/off function when ACM is not installed.

Lonestar Racing Fire Extinguisher Support

Maverick R, Maverick R MAX

715007320



- Quick-release support that lets riders slide the fire extinguisher out in a matter of seconds in an emergency.
- Made of billet anodized black aluminum.
- Fits 1.85" (4.7 cm) tubing.
- Can be fixed anywhere on the cage.
- Provides riders with the safety and security of knowing they have dependable emergency equipment on board.
- Comes with both billet mounts, quick-pull pin, mounting plate and two clamps.
- Fire extinguisher sold separately.
- "Lonestar Racing for Can-Am" branded.
- Incompatible with LinQ Pivoting Rack (715009465).

Performance Air Filter by Twin AIR†

Maverick R, Maverick R MAX

715002895



- The best choice for the harshest conditions.
- Multiple staged oiled filtering foam for superior dust retaining capacity with high airflow.
- Washable and reusable.

Digitally Encoded Security System (D.E.S.S.) Green Key

Maverick R, Maverick R MAX

710005232



- Top-security anti-theft protection for your vehicle.
- Encrypted chip technology restricts access to your vehicle's electronic ignition system.
- One vehicle/one code.
- A vibration/shock-resistant ball-and-socket design that ensures a reliable connection.
- 2 programmable modes:
 - Normal mode: configurable, limits vehicle speed to 70 km/h (44 mph) and may have torque reduction.
 - Performance mode: No restrictions.

CAN-AM MAVERICK



CAN-AM MAVERICK

COMPARATIVE CHART 106

ACCESSORIES 108

Roofs	109
Soft Cab Enclosure	110
Windshields & Wind Protection	110
Mirrors	112
Doors	113
Seat Accessories	114
HMWPE Skid Plates	115
Bumpers & Guards	116
LinQ: Easy On, Easy Off Cargo	119
Racks & Storage	125
ACM & SMART Accessories	127
Lights	129
Audio & Communication Systems	136
Electrical & Electronic Accessories	137
Winches & Hitches	138
Performance	142
Apache Track Systems	143
ProMount Plows	146
Cover & Trailering	149







MAVERICK DS TURBO RR

MAVERICK X RC TURBO RR

MAVERICK X RS TURBO RR

COLOR OPTIONS

SCANDI BLUE ORANGE CRUSH

LOFT GREEN SATIN

Type		Turbo RR	Turbo RR	Turbo RR
ENGINES	Fuel Delivery System	200 hp, Rotax ACE (Advanced Combustion Efficiency) 900 cc Turbocharged Triple-cylinder engine, liquid cooled with integrated intercooler and high-performance air filter	200 hp, Rotax ACE (Advanced Combustion Efficiency) 900 cc Turbocharged Triple-cylinder engine, liquid cooled with integrated intercooler and high-performance air filter	200 hp, Rotax ACE (Advanced Combustion Efficiency) 900 cc Turbocharged Triple-cylinder engine, liquid cooled with integrated intercooler and high-performance air filter
	Transmission	Intelligent Throttle Control (iTC™) with Electronic Fuel Injection (EFI)	Intelligent Throttle Control (iTC™) with Electronic Fuel Injection (EFI)	Intelligent Throttle Control (iTC™) with Electronic Fuel Injection (EFI)
	Drive Train	pDrive primary and Quick Response System X (QRS-X) CVT with high airflow L / H / N / R / P	pDrive primary and Quick Response System X (QRS-X) CVT with high airflow L / H / N / R / P	pDrive primary and Quick Response System X (QRS-X) CVT with high airflow L / H / N / R / P
	Power Steering	Lockable front differential with exclusive Smart-Lok* True 2WD / 4WD with front diff. lock / 4WD TRAIL ACTIV / 4WD TRAIL	Lockable front differential with exclusive Smart-Lok* technology. True 4 modes traction system: 2WD / 4WD with front diff. lock / 4WD ROCK / 4WD TRAIL	Lockable front differential with exclusive Smart-Lok* True 2WD / 4WD with front diff. lock / 4WD TRAIL ACTIV / 4WD TRAIL
	Power Steering	High torque Tri-Mode Dynamic Power Steering (DPS™)	High torque Tri-Mode Dynamic Power Steering (DPS™)	High torque Tri-Mode Dynamic Power Steering (DPS™)
SUSPENSIONS	Front Suspension	Double A-arm with sway bar / 20 in. (50.8 cm) suspension travel	Trophy truck inspired double arched A-arm with sway bar / 22 in. (55.9 cm) suspension travel	Double A-arm with sway bar / 22 in. (55.9 cm) suspension travel / Trophy truck inspired arms
	Front Shocks	SHOWA HPG piggyback 2.5 (Dual Speed Compression, Dual-rate spring)	FOXt 2.5 PODIUM RC2† Piggyback with bypass, dual speed compression and rebound adjustments	FOXt 2.5 PODIUM RC2† Piggyback with bypass, dual speed compression and rebound adjustments
	Rear Suspension	4-link Torsional Trailing-arm X (TTX) with sway bar / 20 in. (50.8 cm) suspension travel	4-link Torsional Trailing-arm X (TTX) with sway bar and arched lower links / 24 in. (61 cm) suspension travel	4-link Torsional Trailing-arm X (TTX) with sway bar / 24 in. (61 cm) suspension travel
	Rear Shocks	SHOWA HPG piggyback 2.5 (Dual Speed Compression, Dual-rate spring)	FOXt 3.0 PODIUM RC2† with bypass, dual speed compression and rebound adjustments	FOXt 3.0 PODIUM RC2† with bypass, dual speed compression and rebound adjustments
TIRES / WHEELS	Front / Rear Tires	XPS Trac Force 30 x 10 x 14 in.	XPS Hammer King 32 x 10 x 15 in.	XPS Trac Force 32 x 10 x 15 in.
	Wheels	14 in. cast-aluminum	15 in. cast-aluminum beadlock	15 in. cast-aluminum beadlock
BRAKES	Front	Dual 262 mm disc brakes with hydraulic twin-piston calipers	Dual 262 mm disc brakes with hydraulic twin-piston calipers	Dual 262 mm disc brakes with hydraulic twin-piston calipers
	Rear	Dual 248 mm disc brakes with hydraulic twin-piston calipers	Dual 248 mm disc brakes with hydraulic twin-piston calipers	Dual 248 mm disc brakes with hydraulic twin-piston calipers
DIMENSIONS / CAPACITIES	Cage	Dual-phase 980 steel	Dual-phase 980 steel	Dual-phase 980 steel
	Estimated Dry Weight*	1,546 lb (701.3 kg)	1,843 lb (836 kg)	1,680 lb (762 kg)
	L x W x H	132 x 64 x 65.4 in. (335.3 x 162.5 x 166.1 cm)	134.5 x 72.8 x 68.5 in. (341.6 x 184.9 x 174 cm)	132 x 72.7 x 68.5 in. (335.3 x 184.7 x 174 cm)
	Wheelbase	102 in. (259.1 cm)	102 in. (259.1 cm)	102 in. (259.1 cm)
	Ground Clearance	14 in. (35.6 cm)	16 in. (40.6 cm)	16 in. (40.6 cm)
	Cargo Box Capacity	200 lb (91 kg) with LinQ™ quick-attach	200 lb (91 kg) with LinQ™ quick-attach	200 lb (91 kg) with LinQ™ quick-attach
	Storage Capacity	Total: 2.5 gal (9.4 L)	Total: 2.5 gal (9.4 L)	Total: 2.5 gal (9.4 L)
	Fuel Capacity	10.5 gal (40 L)	10.5 gal (40 L)	10.5 gal (40 L)
FEATURES	Gauge	4.5 in. wide digital display with keypad	4.5 in. wide digital display with keypad & 10.25 in. touchscreen display	7.6 in. wide digital display with keypad
	Magneto	850-W	850-W	850-W
	Instrumentation	DC outlet (10-A)	DC outlet (10-A)	DC outlet (10-A)
	Lighting	LED Headlight LED tail lights	LED Headlight LED Signature LED tail lights	LED Headlight LED Signature LED tail lights
	Winch	N/A	4,500 lb (2,041 kg) winch with synthetic rope	N/A
	Anti-theft System	RF Digitally Encoded Security System (D.E.S.S.™) with Start/Stop button	RF Digitally Encoded Security System (D.E.S.S.™) with Start/Stop button	RF Digitally Encoded Security System (D.E.S.S.™) with Start/Stop button
	Protection	Integrated front bumper Quarter-doors Full heavy-duty HMW plastic skid plate Rear tow hook	Front bumper Half-doors Aluminum roof Intrusion bar 4-point harness with shoulder pads UHMWPE rock sliders HMWPE skid plates: Full heavy duty with differential / Under bumper / Front and rear suspension arm Rear tow hook Trailing Arm protector	Integrated front bumper Quarter-doors Full hard roof 4-point harness with shoulder pads HMWPE full skid plate Rear tow hook

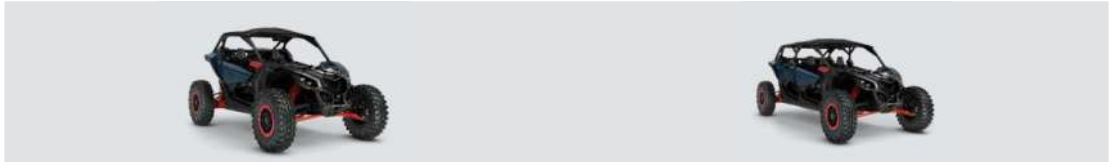

MAVERICK X RS TURBO RR SAS

MAVERICK MAX X RS TURBO RR SAS

COLOR OPTIONS

	MAVERICK X RS TURBO RR SAS	MAVERICK MAX X RS TURBO RR SAS	
ENGINES	Type	Turbo RR	Turbo RR
	Fuel Delivery System	200 hp, Rotax ACE (Advanced Combustion Efficiency) 900 cc Turbocharged Triple-cylinder engine, liquid cooled with integrated intercooler and high-performance air filter	200 hp, Rotax ACE (Advanced Combustion Efficiency) 900 cc Turbocharged Triple-cylinder engine, liquid cooled with integrated intercooler and high-performance air filter
	Transmission	Intelligent Throttle Control (ITC™) with Electronic Fuel Injection (EFI)	Intelligent Throttle Control (ITC™) with Electronic Fuel Injection (EFI)
	Drive Train	pDrive primary and Quick Response System X (QRS-X) CVT with high airflow L / H / N / R / P	pDrive primary and Quick Response System X (QRS-X) CVT with high airflow, L / H / N / R / P
	Power Steering	Lockable front differential with exclusive Smart-Lok* True 2WD / 4WD with front diff. lock / 4WD TRAIL ACTIV / 4WD TRAIL	Lockable front differential with exclusive Smart-Lok* True 2WD / 4WD with front diff. lock / 4WD TRAIL ACTIV / 4WD TRAIL
	Power Steering	High torque Tri-Mode Dynamic Power Steering (DPS™)	High torque Tri-Mode Dynamic Power Steering (DPS™)
SUSPENSIONS	Front Suspension	Double A-arm with sway bar / 22 in. (55.9 cm) suspension travel / Trophy truck inspired arms	Double A-arm with sway bar / 22 in. (55.9 cm) suspension travel / Trophy truck inspired arms
	Front Shocks	FOX† 2.5 PODIUM† Piggyback with bypass and Smart-Shox Technology featuring DDA Valve (Dynamic Damping Adjustment)	FOX† 2.5 PODIUM† Piggyback with bypass and Smart-Shox Technology featuring DDA Valve (Dynamic Damping Adjustment)
	Rear Suspension	4-link Torsional Trailing-arm X (TTX) with sway bar / 24 in. (61 cm) suspension travel	4-link Torsional Trailing-arm X (TTX) with sway bar / 22 in. (55.9 cm) suspension travel
	Rear Shocks	FOX† 3.0 PODIUM† with bypass and Smart-Shox Technology featuring DDA Valve (Dynamic Damping Adjustment)	FOX† 3.0 PODIUM† with bypass and Smart-Shox Technology featuring DDA Valve (Dynamic Damping Adjustment)
TIRES / WHEELS	Front / Rear Tires	XPS Trac Force 32 x 10 x 15 in.	XPS Trac Force 32 x 10 x 15 in.
	Wheels	15 in. cast-aluminum beadlock	15 in. cast-aluminum beadlock
BRAKES	Front	Dual 262 mm disc brakes with hydraulic twin-piston calipers	Dual 262 mm disc brakes with hydraulic twin-piston calipers
	Rear	Dual 248 mm disc brakes with hydraulic twin-piston calipers	Dual 248 mm disc brakes with hydraulic twin-piston calipers
DIMENSIONS / CAPACITIES	Cage	Dual-phase 980 steel	Dual-phase 980 steel
	Estimated Dry Weight*	1,699 lb (770.7 kg)	1,942 lb (880.9 kg)
	L x W x H	132 x 72.7 x 68.5 in. (335.3 x 184.7 x 174 cm)	165 x 72.7 x 68.5 in. (419.1 x 184.7 x 174 cm)
	Wheelbase	102 in. (259.1 cm)	135 in. (342.9 cm)
	Ground Clearance	16 in. (40.6 cm)	16 in. (40.6 cm)
	Cargo Box Capacity	200 lb (91 kg) with LinQ™ quick-attach	150 lb (68 kg) with LinQ™ quick-attach
	Fuel Capacity	Total: 2.5 gal (9.4 L)	Total: 3 gal (11.4 L)
FEATURES	Gauge	4.5 in. wide digital display with keypad & 10.25 in. touchscreen display	4.5 in. wide digital display with keypad & 10.25 in. touchscreen display
	Magneto	850-W	850-W
	Instrumentation	DC outlet (10-A)	DC outlet (10-A)
	Lighting	LED Headlight LED Signature LED tail lights	LED Headlight LED Signature LED tail lights
	Winch	N/A	N/A
	Anti-theft System	RF Digitally Encoded Security System (D.E.S.S.™) with Start/Stop button	RF Digitally Encoded Security System (D.E.S.S.™) with Start/Stop button
	Protection	Integrated front bumper Quarter-doors Full hard roof 4-point harness with shoulder pads Full heavy-duty HMW plastic skid plate Rear tow hook	Integrated front bumper Quarter-doors Full hard roof 4-point harness with shoulder pads Full heavy-duty HMW plastic skid plate Rear tow hook

MAVERICK HERO UNITS PACKAGES

ESSENTIALS	PACKAGE	DESCRIPTION	MAVERICK
	Starter	Electronic Device Holder	715002874
		Color Touchscreen Display Protector	860202680*
		Can-Am Rockford Fosgate Audio Roof – Level 4	715010098** / 715010099**
		Glass Windshield	715008859
		Rear Wind Screen	715006701***
		Upper Soft Door Panels	715008091*** / 715008092***
		Side Mirrors	715004236
		Emergency Kit	715006102
<p>* Except models without touchscreen display. ** For models without touchscreen display change to SKUs 715007130 & 715006709 (MAX). *** Except X mr models.</p>			
+			
	Protection	Front Pre-Runner Bumper	715002878
		Rear Pre-Runner Bumper	715002880
		Rock Sliders	715002963* / 715003730
<p>* Except X RC models. ** To complete the package we recommend the installation of a Skid Plate Protection Kit.</p>			
+			
	Cargo	Overhead Storage Bag	715004275
		Upper Door Storage Bags	715004276
		Shoulder Storage Bag	715004277*
		LinQ Pivoting Rack	715010786**
<p>* Except X mr models. ** Except X mr & X RC with Smart-Shox models.</p>			
+			
	Smart (models with touchscreen display)	Accessory Control Module	715010097
		Rear ACM Harness	715009268
		SMART Control Center for ACM	715010834
		SMART Integrated LED Roof Light	715010102
		SMART 10" (25 cm) LED Light Bar	715008745
		SMART Windshield Wiper & Washer Kit	715003282

ROOFS

Sport Roof	Maverick	715005521
	Maverick MAX	715003750



- Impact-resistant injected polypropylene.
- Excellent protection from the elements.
- Provides excellent downhill visibility.
- Windshield compatible.
- Standard on X rs model.
- Easy, tool-less installation and removal with quick-release ¼ turn fasteners and Velcro straps.

ProVent Roof Module Kit	Maverick, Maverick MAX	715005279
--------------------------------	------------------------	------------------



- Provides fresh air in the cab area.
- Optimal performance with full cab enclosure.
- 4 vents provide infinite adjustment of air flow for driver and passenger.
- Filter and pre-filter to limit dust intrusion.
- Easy cleaning of filter and pre-filter.
- Patent pending water management system to keep water out of cabin while maintaining air flow.
- Outer plug closes air intake completely for winter or heavy weather.
- Sport Roof requires ProVent Module Adapter Kit.
- Not compatible with roof mounted LED bars, roof racks (715006225/715003868) or roof liners, Lonestar Roof, or Bimini tops.

ProVent Roof Module Adapter Kit for Sport Roof <i>(Not illustrated)</i>	Maverick	715006199
	Maverick MAX	715006371

- Adapter for fitting ProVent Roof Module Kit onto Maverick.
- Includes roof adapter and hardware.
- Requires ProVent Roof Module Kit (715005279).

Aluminum Roof	Maverick	■ 715004224 • Black
		■ 715002900 • Silver



- Formed aluminum roof 0.09" (2.3 mm) thick.
- Durable and lightweight.
- Sporty look.
- Windshield compatible.
- Easy and tool-less installation.

Bimini[®] Roof with Sun Visor	Maverick	715002901
	Maverick MAX	715003749



- Heavy-duty canvas made of UV-resistant solution-dyed polyester.
- Innovative soft top comes with a hard visor that allows for storage of rolled-up soft top.
- Easy, tool-less installation and removal with quick-release/turn fasteners and Velcro straps.

Tinted Sun Visor	Maverick, Maverick MAX	715007098
-------------------------	------------------------	------------------



- Tinted polycarbonate construction.
- Extra protection for driver and passenger from the sun.
- Not compatible with Aluminum Roof, Audio Roof or Full Windshields.

Lonestar Racing Aluminum Roof	Maverick produced after January 1, 2017	■ 715005507 • Black
	Maverick MAX	■ 715005515 • Black



- 0.083" (2.1 mm) thick aluminum roof.
- Durable and lightweight.
- Enhances the vehicle's racing appearance thanks to an authentic sporty look combined with unique graphics.
- Offers you protection from the elements with a personalized touch.
- Lower profile than other roofs.
- Compatible with Lonestar Racing Light Bar Racks.
- Not compatible with LinQ[®] Pivoting Rack, Light Support Bar and Full Windshields.
- "Lonestar Racing for Can-Am" branded.
- Includes middle intrusion bars for installation.

SOFT CAB ENCLOSURE

Soft Cab Enclosure	Maverick (except X mr models)	715003754
	Maverick MAX (except X mr models)	715003755



- Protection for rider and passenger from the elements.
- For added cabin comfort, complete your cab enclosure with Cab Seal Kit.
- Includes:
 - Bimini roof with sun visor
 - Full windshield — hardcoated
 - Upper soft door panels
 - Front lower door panels
 - Soft rear window

Cab Seal Kit <i>(Not illustrated)</i>	Maverick	715004433
	Maverick MAX	715004434

- Prevents dirt, dust and wind infiltration in the cab area.
- Improves cabin comfort for driver and passenger.
- Recommended with Soft Cab Enclosures.

WINDSHIELDS & WIND PROTECTION

WINDSHIELDS

PowerFlip Windshield	Maverick, Maverick MAX	715007097
-----------------------------	------------------------	------------------



- The PowerFlip Windshield is equipped with electric cylinders that allow the rider to adjust the windshield opening at the touch of a button.
- Windshield is made of hardcoated polycarbonate with a rubber seal contour and a tinted top section.
- Allows you to quickly adapt to changing conditions by adjusting the windshield as you go.
- Can be fully opened for optimal visibility and ventilation, fully closed for maximum protection from the elements, and in between, you have an infinite number of opening possibilities depending on protection, visibility and air flow preferences.
- Compatible with Can-Am roofs.

Windshield Wiper for PowerFlip Windshield	Maverick, Maverick MAX	715006310
--	------------------------	------------------



- An ideal way to keep your windshield clear in rain or while riding through mud and water.
- Wiper from the top allows windshield pivoting. Includes single-speed wiper and washer-fluid dispenser.
- Wiper mechanism and washer-fluid dispenser perfectly concealed within the vehicle.
- Must be installed with the PowerFlip Windshield (sold separately).

Provent Windshield	Maverick, Maverick MAX	715005277
---------------------------	------------------------	------------------



- High-impact-resistant Quantum hardcoated polycarbonate full windshield.
- Controllable vents to manage air flow.
- Optimal performance with full cab enclosure.
- Channels air into the cabin, defogs windshield, fully closes to eliminate air flow.
- One upper vent and one lower vent with pre-filters.
- Formed polycarbonate construction for enhanced rigidity.
- Protects driver and passenger from the elements.
- Quick and easy tool-less installation or removal.
- Not compatible with wiper kits and Wet Sounds Stealth 6 Ultra HD Can-Am Edition Sound Bar.
- Upper vent channels air into the cabin.
- Lower vents defog windshield.
- Provides excellent optical clarity and better abrasion resistance.

Glass Windshield	Maverick, Maverick MAX	715008859
-------------------------	------------------------	------------------



- Curved and laminated glass full windshield.
- Seals firmly against the cage and protects rider and passenger from the elements.
- Provides the best optical clarity and abrasion resistance.
- Must be used with Windshield Wiper & Washer Kit to maintain clear visibility during severe riding conditions, such as mud riding.
- Recommended to use with rear wind protection to maximize comfort for passenger.

Glass Windshield with SMART Wiper & Washer Kit	Maverick, Maverick MAX	715008858
---	------------------------	------------------



- Complete kit that includes a curved and laminated glass windshield with a single-speed wiper and washer fluid dispenser.
- Seals firmly against the cage and protects rider and passenger from the elements.
- An ideal way to keep your windshield clear in rain, or while riding through mud and water.
- Recommended to use with rear wind protection to maximize comfort for passenger.
- Smart and fixed intermittence wiper speed feature available when the kit is installed in combination with ACM.

Full Windshield	Maverick, Maverick MAX	715002907
------------------------	------------------------	------------------



- High-impact-resistant durable polycarbonate full windshield.
- Formed polycarbonate construction for enhanced rigidity.
- Formulated to be non-yellowing, non-crazing, non-cracking with excellent UV resistance and optical clarity.
- Protects driver and passenger from the elements.
- Quick and easy tool-less installation or removal.
- Recommended to use with rear wind protection to maximize comfort for passenger.

Full Windshield – Hardcoated	Maverick, Maverick MAX	715004417
-------------------------------------	------------------------	------------------



- High-impact-resistant Quantum hardcoated polycarbonate full windshield.
- Formed polycarbonate construction for enhanced rigidity.
- Provides excellent optical clarity and better abrasion resistance.
- Protects driver and passenger from the elements.
- Quick and easy tool-less installation or removal.
- Recommended to use with rear wind protection to maximize comfort for passenger.
- Can be used with the SMART Windshield Wiper and Washer Kit (715004762).

Half Windshield	Maverick, Maverick MAX	<input type="checkbox"/> 715002909 • Clear <input type="checkbox"/> 715004291 • Tinted
------------------------	------------------------	---



- High-impact-resistant durable polycarbonate half windshield.
- Formed polycarbonate construction for enhanced rigidity.
- Formulated to be non-yellowing, non-crazing, non-cracking with excellent UV resistance and optical clarity.
- Protects driver and passenger from the elements.
- Features reverse angle lip to deflect air flow.
- Quick and easy tool-less installation or removal.

SMART Windshield Wiper & Washer Kit	Maverick, Maverick MAX Fit with Full Windshield Hardcoated (715004417)	715004762
	Maverick, Maverick MAX Fit with Glass Windshield (715008859)	715003282



- An ideal way to keep your windshield clear in rain, or while riding through mud and water.
- Includes single-speed wiper and washer fluid dispenser.
- Wiper mechanism and washer fluid dispenser perfectly concealed within the vehicle.
- Smart and fixed intermittence wiper speed feature available when the kit is installed in combination with ACM.

Manual Wiper Kit	Maverick, Maverick MAX	715009424
-------------------------	------------------------	------------------



- Single manual wiper that can be used to clear windshield of debris.
- Easy to install system that requires no electrical hookup.
- Large ergonomic handle provides a good grip over the entire sweeping surface.
- Compatible with glass and hardcoated windshields that use top mounted wipers.

WIND PROTECTION

Rear Wind Screen	Maverick, Maverick MAX (except X mr models)	715006701
-------------------------	---	------------------



- Full rear mesh screen reduces windshield backdraft for added cabin comfort.
- Installs quickly and easily on roll cage.
- Large white Can-Am logo on black mesh.

Rear Polycarbonate Window	Maverick, Maverick MAX (except X mr models)	715006387
----------------------------------	--	------------------



- High-impact-resistant polycarbonate window.
- Blocks windshield backdraft or dust and rain from entering for added cabin comfort.
- Quick and easy tool-less installation.
- Ready for MTX Audio System Rear Speakers.

Soft Rear Window	Maverick, Maverick MAX (except X mr models)	715006702
-------------------------	--	------------------



- Clear, flexible window made from transparent vinyl.
- Resists cold-cracking to -4°F (-20°C).
- Ideal for preventing backdraft of dust or rain in harsh environments.
- Quick tool-less installation.

MIRRORS

Aluminum Side Mirrors	Maverick, Maverick MAX	715007363
------------------------------	------------------------	------------------



- Sleek design.
- High-quality black molded aluminum for extreme durability.
- The convex surface provides a wider field of view and better visibility around the unit.
- Can be installed at any height on the cage A-pillar for optimized rider vision.
- Possibility to install the Integrated SMART LED Side Mirror Lights (715007185).
- Adjustable ball-joint mirrors.
- Possibility to fold down the mirrors (fold-away mechanism).
- Not compatible with Glass Windshield and upper soft door panel.
- Sold in pairs.

Side Mirrors	Maverick, Maverick MAX	715007188
---------------------	------------------------	------------------



- Sleek design.
- High-impact resistant plastic mirrors.
- The convex surface provides a wider field of view and better visibility around the unit.
- Can be installed at any height on the cage A-pillar for optimized rider vision.
- Adjustable ball-joint mirrors.
- Possibility to fold down the mirrors (fold-away mechanism).
- Not compatible with Glass Windshield and upper soft door panel.
- Sold in pairs.

Side Mirrors	Maverick, Maverick MAX	715004236 • For stock quarter doors 715005315 • For aluminum doors
---------------------	------------------------	---



- Rugged cast aluminum mount with black nylon cover.
- Multi-position adjustable ball-joint mounted mirrors.
- Convex optics for a wide viewing angle.
- Spring-loaded pivots let mirrors fold back completely.
- Door mounted.
- Compatible with Upper Soft Door Panels.
- Sold in pairs.

Racing Side Mirrors	Maverick, Maverick MAX	715002898
----------------------------	------------------------	------------------



- Race-inspired design features rugged black nylon ½ construction with coated cast-aluminum mount.
- Dual adjustment provides optimal field of view (FOV).
- Multi-position adjustable ball-joint mounted mirrors.
- Flat optics deliver improved distance perception.
- Spring-loaded pivots let mirrors fold back completely.
- Not compatible with Lonestar Racing Light Racks, Upper Soft Door Panels or Flip Audio Roof Kit (715007131).
- Sold in pairs.

Rally Side Mirrors

Maverick, Maverick MAX

715005262



- Sleek design with unique racing style.
- High-quality black molded aluminum for extreme durability.
- 4" (10 cm) convex surface provides a wider field of view and better visibility around the unit.
- Can be installed at any height on the cage A-pillar for optimized rider vision.
- Multi-position adjustable ball-joint-mounted mirrors.
- Spring-loaded pivots let mirrors fold back completely.
- Sold in pairs.
- Not compatible with Glass Windshield.

Rear Mirror & Camera Monitor

Maverick, Maverick MAX

715009410



- Fully waterproof rearview mirror and monitor kit.
- See exactly what you need to see with the multiple camera feeds from the rear view camera.
- This unit replaces the stock rearview mirror (the screen is integrated in the unit's replacement rearview mirror).
- The camera uses infrared light for night vision capabilities.

DOORS

Aluminum Half Doors

Maverick, Maverick MAX

715007971 • Front

Maverick MAX

715007972 • Rear



- Lightweight half doors made of formed $\frac{5}{64}$ " (2 mm) thick aluminum.
- Smooth finish.
- Engineered for maximum rigidity and durability.
- Designed for a perfect fit and seamless integration with the vehicle's lines.
- Contoured with a thick seal for better protection from the elements.
- Easy installation using the standard door frame.
- Includes the easy-to-operate Deluxe Door Handles.
- Compatible with the Upper Soft Door Panels, the Window Nets and Upper Door Storage Bags.
- Not compatible with the Lower Door Panel Storage Bags.
- Sold in pairs.

Deluxe Door Handles

Maverick, Maverick MAX

715004758 • Front

Maverick MAX

715004860 • Rear

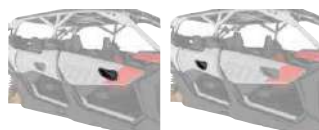

- Convert the standard door straps into easy-to-access door handles.
- Include inside and outside handles for each door.
- Greatly facilitate door opening.
- Standard on accessory Aluminum Half Doors.
- Sold in pairs.

Lower Door Panels

Maverick, Maverick MAX

715002903 • Front

715003751 • Rear

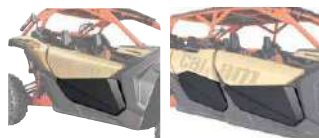

- Robust injection-molded polypropylene construction designed to match vehicle.
- Extend stock doors at bottom to protect from the elements.
- A great-looking add-on.
- Easy and quick installation.
- Sold in pairs.

Window Nets

Maverick

715006693 • Front

Maverick MAX

715004694 • Front

Maverick MAX

715006700 • Rear



- Window mesh screen for added protection from wind.
- Can be easily lowered in seconds.
- Sold in pairs.
- Not compatible with Can-Am Audio Roof.

Upper Soft Door Panels	Maverick (except X mr models)	715008091 • 2 doors
	Maverick MAX (except X mr models)	715008092 • 4 doors



- Weather-resistant panels reinforced with aluminum frame offer good protection from the elements.
- Extend stock quarter doors at the top.
- Made of heavy-duty UV-resistant solution-dyed polyester canvas for excellent resistance to tear and abrasion.
- Zip-down windows made of laminated polished vinyl material for added ventilation.
- To be combined with the Lower Door Panels to obtain complete door kits for your vehicle.
- Not compatible with Racing Side Mirrors, Side Mirrors, Aluminum Side Mirror and Can-Am Audio Roof.

SEAT ACCESSORIES

4-Point Harness	Maverick, Maverick MAX	715008033 • Driver
		715008034 • Passenger



- Exclusive controlled decelerator technology (patent pending) absorbs additional energy in case of accident.
- Designed to offer maximum riding comfort.
- Easy one-click latch and release.
- Patent pending.
- Not EC compliant.

Retractable 4-Point Harness	Maverick, Maverick MAX	715005021 • Driver
		715005022 • Passenger



- Convenient harness allows you to move freely in your seat and at the same time fully benefit from the extra support given by the 4-point attachments.
- Makes it easier to buckle up and requires fewer adjustments when switching passenger or driver.
- Retractor Protector (707900653) is required for installation on front seats of MAX models.
- Compatible with rear passengers' seats on MAX models.
- Standard on select Maverick models.

Retractor Protector <i>(Not illustrated)</i>	Maverick MAX	707900653
--	--------------	------------------

- Protective pad required for the installation of the Retractable 4-Point Harness on front seat of MAX models.
- Protects the passengers from the retractor mechanism.
- Sold individually.

Seat Belt Shoulder Pads	Maverick, Maverick MAX	715002894
--------------------------------	------------------------	------------------



- Provide additional riding comfort by preventing seat belt from rubbing on neck and shoulder.
- Fit with stock 3-point seat belts and 4 point harness.
- Easy Velcro installation.
- Can-Am branded.
- Sold in pairs for driver and passenger.

HMWPE SKID PLATES

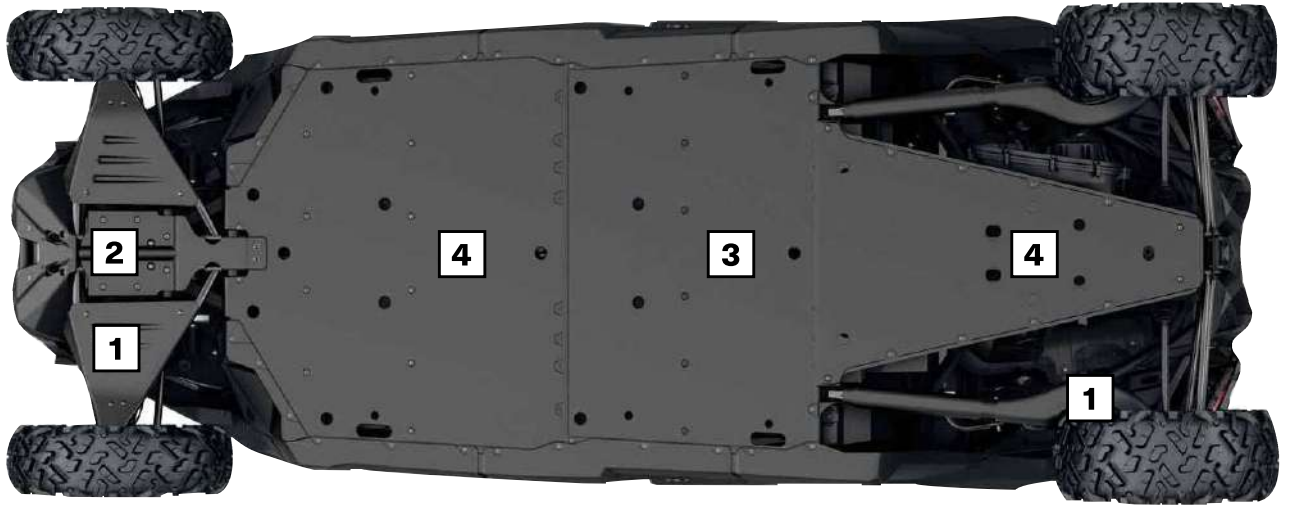

Our plastic plates glide smoothly and silently over obstacles, offering great protection in rough terrain. Made of abrasion-resistant thermoformed $\frac{3}{8}$ " (10 mm) thick High Molecular Weight Polyethylene (HMWPE).

- Lighter than aluminum.
- Superior stress crack resistance.
- High-impact strength.

MAVERICK, MAVERICK MAX

HMWPE Skid Plates are standard on X rs models (2019 to 2021) and X rc models (2022 & up) only.	Maverick 64" models	Maverick Max 64" models	Maverick, Maverick Max 72" models (except Base models)	Maverick Base 72" models	Maverick Max Base 72" models
HMWPE SKID PLATE PROTECTION KIT					
	715003713	715003747	715003718	715006767	715006769
INDIVIDUAL HMWPE SKID PLATES					
1 HMWPE Front A-Arm and Trailing Arm Protectors	715002905	715002905	715003552	715003552	715003552
2 HMWPE Front Skid Plate	715003933	715003933	715003933	715003933	715003933
3 HMWPE Central Skid Plate	—	715003731	Standard on X rc models only	—	715003731
4 HMWPE Underbelly Plate	715004904	715004904	Standard on X rc models only	715004904	715004904

BUMPERS & GUARDS

BUMPERS

Front Pre-Runner Bumper

Maverick, Maverick MAX

■ **715002878** • Black
■ **715003433** • Can-Am Red



- Made of 1.5" (3.8 cm) diameter steel tubing with a 1/8" (3 mm) aluminum plate for extra durability.
- Inside and outside anti-corrosion coating with durable powder coat finish.
- Added heavy-duty protection in extreme driving conditions.
- Integrated winch mounting plate and mount points for lights.

Rear Pre-Runner Bumper

Maverick, Maverick MAX

■ **715002880** • Black
■ **715003436** • Can-Am Red



- Extra-durable 1.5" (3.8 cm) diameter steel tubing with a 1/8" (3 mm) aluminum plate.
- Inside and outside anti-corrosion coating with durable powder coat finish.
- Protects vehicle bodywork and exhaust system.
- Rear Receiver Hitch compatible.
- Required for installation of the Rear Cage Extension.

Dune Front Bumper

Maverick, Maverick MAX

■ **715002961** • Black
■ **715003432** • Can-Am Red



- Made of 1.5" (3.8 cm) diameter aluminum tubing with a 1/8" (3 mm) aluminum plate.
- Inside and outside anti-corrosion coating with durable powder coat finish.
- Provides added protection without sacrificing the agility and performance advantages of a lighter weight design.
- Features a more pronounced attack angle and integrated mounting points for lights.
- Not winch compatible.

Dune Rear Bumper

Maverick, Maverick MAX 2021 & prior
Maverick, Maverick MAX 2022 & up

■ **715002962** • Black
■ **715003437** • Can-Am Red
■ **715009242** • Black



- Made of 1.5" (3.8 cm) diameter aluminum tubing with a 1/8" (3 mm) aluminum plate.
- Inside and outside anti-corrosion coating with durable powder coat finish.
- Provides added protection without sacrificing the agility and performance advantages of a lighter weight design.
- Protects vehicle bodywork and exhaust system.
- Rear hitch compatible.
- Not compatible with Rear Cage Extension and Lonestar Racing Spare Tire Holder.

X rc/X mr Front Bumper

Maverick, Maverick MAX

■ **715004788** • Black



- Made of 1.5" (3.8 cm) diameter steel tubing with a 1/8" (3 mm) aluminum plate.
- Inside and outside anti-corrosion coating with durable powder coat finish on steel tubing.
- Offers all the essential features required for technical driving: low front-end protection, support base for winch installation and integrated tow hook.
- Standard on Maverick X rc and X mr models.
- Not compatible with winches with steel cable.

Lonestar Racing Front Bumper

Maverick, Maverick MAX
(not compatible X mr and X rc models)

■ **715005510** • Hyper Silver
■ **715005509** • Black



- Made of 1.5" (3.8 cm) diameter steel tubing with durable powder coat finish and a 1/8" (3 mm) thick aluminum plate for added vehicle-front protection in extreme driving conditions.
- Sleek styling enhances the vehicle's race-inspired look.
- Not winch compatible.
- Not compatible with 10" (25 cm) Baja Designs OnX6 LED Light Bar and SMART 10" (25 cm) LED Light Bar (715008745).
- Not compatible with stock Smart-Shox.

Lonestar Racing Rear Bumper

Maverick, Maverick MAX 2021 & prior

- **715005512** • Hyper Silver
- **715005511** • Black
- **715004162** • Can-Am Red



- Made of 1.5" (3.8 cm) diameter steel tubing with durable powder coat finish.
- Provides additional vehicle-rear bodywork and exhaust system protection in extreme driving conditions.
- Sleek styling enhances the vehicle's race-inspired look.
- Compatible with Lonestar Racing Spare Tire Holder.
- Not hitch compatible.

S3⁺ Front Bumper

Maverick, Maverick MAX

- **715004867** • Black



- Made of 1.5" (3.8 cm) diameter steel tubing with a 1/8" (3 mm) aluminum plate for extra durability.
- Inside and outside anti-corrosion coating with durable powder coat finish.
- Added heavy-duty protection in extreme driving conditions.
- Integrated winch support plate and mount points for lights.
- Hook support anchor allows you to keep the winch hook within easy reach when riding in deep mud.
- "S3 for Can-Am" branded.
- Winch not included.

S3 Rear Bumper

Maverick, Maverick MAX 2021 & prior

- **715004869** • Black



- Made of extra-durable 1.5" (3.8 cm) diameter steel tubing.
- Inside and outside anti-corrosion coating with durable powder coat finish.
- Added heavy-duty protection in extreme driving conditions—protects vehicle bodywork and exhaust system.
- Permits installation of a winch at a higher location to improve accessibility in muddy conditions.
- "S3 for Can-Am" branded.
- Engineered to sustain heavy winch loads without damaging the vehicle's frame.
- Compatible with Can-Am HD and WARN VRX winches—Rear Winch Harness (715006007) is required to install a winch on the bumper.
- Includes a robust recovery hook to facilitate vehicle recovery.
- Winch not included.
- Not EC compliant.

ROCK SLIDERS

Rock Sliders

Maverick (except X rc)

- **715002963** • Black
- **715003438** • Can-Am Red
- **715003730** • Black
- **715003888** • Can-Am Red

Maverick MAX



- Made of heavy-duty 1.5" (3.8 cm) diameter steel tubing.
- Inside and outside anti-corrosion coating with durable powder coat finish.
- Protect vehicle's sides and undercarriage against large obstacles.
- Support plate adds rigidity and style.
- Sold in pairs.

Lonestar Racing Rock Sliders

Maverick (except X rc models)

- **715005514** • Hyper Silver
- **715008845** • Black
- **715008846** • Can-Am Red
- **715008847** • Black
- **715008848** • Can-Am Red

Maverick MAX



- Race-engineered to Lonestar Racing's trademark standards for toughness, these stylishly crafted accessories will also enhance your vehicle with visual impact.
- Made of 1.5" (3.8 cm) diameter steel tubing with durable powder coat finish.
- Essential protection from large obstacles for your vehicle's sides.
- Sold in pairs.
- Maverick MAX: Not compatible with the Rear Aluminum Half Doors (715007972).

INTRUSION BARS

Front Intrusion Bar	Maverick, Maverick MAX	<ul style="list-style-type: none"> ■ 715002889 • Black ■ 715003435 • Can-Am Red
----------------------------	------------------------	---



- Matches vehicle styling.
- Inside and outside anti-corrosion coating with durable powder coat finish steel intrusion bar.
- Tube design reduces obstructed lines of sight and blind spots for better visibility.
- Not compatible with windshields or Lonestar Racing Aluminum Roof.

Lonestar Racing Front Intrusion Bar	Maverick, Maverick MAX	■ 715003916 • Black
--	------------------------	---------------------



- Made of 1.5" (3.8 cm) diameter steel tubing with durable powder coat finish.
- Enhances the racing look of the vehicle.
- Compatible with Lonestar Racing Aluminum Roof and Aluminum Roofs.
- Not compatible with windshields.

Lonestar Racing Rear Intrusion Bar	Maverick (except X mr models), Maverick MAX	■ 715003918 • Black
---	--	---------------------



- Made of 1.5" (3.8 cm) diameter steel tubing with durable powder coat finish.
- Sleek styling enhances the vehicle's race-inspired look.
- Required for the installation of the Lonestar Racing Spare Tire Holder.
- Not compatible with LinQ mounted accessories or Pre-Filter in the cargo bed.

OTHER ACCESSORIES

Fender Flares	Maverick, Maverick MAX	715002973
----------------------	------------------------	-----------



- Extended fender flares made from injection-molded polypropylene.
- Keep mud and debris out of vehicle.
- Designed for quick and easy installation.
- Include front and rear extensions and mounting hardware.

Lonestar Racing Spare Tire Holder	Maverick, Maverick MAX 2021 & prior (except X mr models)	■ 715003922 • Black
--	---	---------------------



- Made of 1.5" (3.8 cm) diameter steel tubing with durable powder coat finish.
- Adjustable height to fit Can-Am tires up to 30 in.
- Requires Lonestar Racing Rear Bumper and Lonestar Racing Rear Intrusion Bar for installation.
- Cannot hold the Pro Armor Quickshot Wheel Jack and Off-Road Screw Jack.
- Wheel not included.
- Not compatible with the S&B Particle Separator or LinQ accessories intended for the rear of the vehicle.

Lonestar Racing Number Plate Holder	Maverick, Maverick MAX	715003943
--	------------------------	-----------



- Includes a pair of sturdy aluminum number plates that mount on either side of the vehicle rear.
- Not compatible with LinQ Pivoting Rack.
- Numbered decals are available through SCS Unlimited.
- Styling enhances the vehicle's race-inspired look while adding a personal touch.
- Black background.

S3 Rear Pull Plate	Maverick, Maverick MAX 2021 & prior	<ul style="list-style-type: none"> ■ 715004870 • Black ■ 715005233 • Can-Am Red
---------------------------	-------------------------------------	---



- Offers a solid place to hook onto in case towing is needed.
- Allows you to attach most straps and hooks.
- "S3 for Can-Am" branded.

LINQ: EASY ON, EASY OFF CARGO

MAVERICK'S LINQ ACCESSORIES

MOUNTING LOCATION AND REQUIREMENTS

<ul style="list-style-type: none"> No tools needed: Quickly install and remove accessories by hand Equip your Can-Am for specialized tasks in no time Sturdy mounting system that holds up to the roughest terrain 	Standard Cargo Bed	LinQ Pivoting Rack 715010786/715008296	Adventure Roof Rack 715003868/715006225
LinQ ACCESSORIES WITH 16" BASE <ul style="list-style-type: none"> LinQ anchors mounted 16 inches apart, center-to-center. Lower loading capacity than the LinQ with 36" base accessories. Can be used on Can-Am ATV and SxS vehicles, Can-Am Spyder and Ryker vehicles, Sea-Doo watercraft and Ski-Doo snowmobiles. 			
NEW LinQ Rigid Cooler 4.7 US Gal (18 L) 715010491			
NEW LinQ Cooler 5.3 US Gal (20 L) 295101257 • Gray			
LinQ 4.2 Gal Cooler 295100698 • White 219400964 • Black			
LinQ Tool Kit 715006829			
LinQ Tool Box 715008111			
LinQ SR 5.5 Gal (21 L) Bag 860202449	LinQ Anchor Adapter Kit 715004960	LinQ Anchor Adapter Kit 715004960	LinQ Base Installation Kit 715008125
LinQ 4.5 Gal (17 L) Sport Bag 860202447			
LinQ Modular Box 715005494 • (10 L) 715007112 • (20 L) 715006830 • (30 L)			
LinQ Roll-Top Bag 715008110			
LinQ 5.3 US Gal (20 L) Semi-Rigid Cooler 295101252			
LinQ ACCESSORIES WITH 36" BASE <ul style="list-style-type: none"> Mount on LinQ racks often used by Can-Am ORV vehicles. Higher loading capacity than the LinQ with 16" base accessories. Usage is limited to Can-Am ORV vehicles. 			
LinQ 12 Gal (45 L) Cargo Box 715003879	No further requirements		
LinQ 23 Gal (86 L) Trunk Box 715004923	No further requirements		
LinQ 32 Gal (121 L) Trunk Box 715001748	*Not compatible if the LinQ Pivoting Rack is installed.		
LinQ 11.5 Gal (43 L) Audio Cargo Box 715003018			
LinQ 8 Gal (30 L) Cooler Box 715004778 • Black		No further requirements	No compatibility
LinQ Premium Storage Bag by OGIO[†] 715002923 • Black	No further requirements		
LinQ Heavy Duty Basket 715001215			
LinQ Low Profile Basket 715004282			
LinQ HOLDERS			
LinQ Gear Grips 715005340	No further requirements	No further requirements	Side wall installation LinQ Adapters 715003058
LinQ Tool Holder 715007358			

The LinQ system is BRP's game-changing, tool-free cargo solution. Snap gear on or off in seconds. No fuss, no rattle, just rock-solid mounting on any terrain.

LINQ SYSTEM ADVANTAGE

ORIGINAL LinQ SYSTEM

Handles medium- to large-sized gear with two anchor setups: the 16" base for standard accessories and the 36" base for racks and serious payloads.

LinQ LITE

Made for smaller items, lightweight gear you can hang from rails or vertical mounts.



LinQ ACCESSORIES WITH 16" BASE

NEW LinQ Rigid Cooler 4.7 US Gal (18 L)

Maverick, Maverick MAX

715010491



- Versatile LinQ 16" configuration fits many vehicles.
- Durable rotomolded rigid construction.
- Molded-in handles for quick installation and removal.
- High quality insulation for optimal ice retention.
- Sealed lid for airtight, weather-tight closure.

- Ergonomic and secure latch system offers excellent sealing.
- 4.7 US gal (18 L) capacity.
- Not compatible below the LinQ Pivoting Rack (715010786 or 715008296).
- See table for installation location and requirements.

NEW LinQ Cooler 5.3 US Gal (20 L)

Maverick, Maverick MAX

295101257



- LinQ-mounted for fast, easy and secure storage.
- Locks in place with just a quarter turn.
- High-quality insulation for optimal ice retention.
- Keeps ice cold for 5 days.
- Rotomolded construction for exceptional rigidity and durability.
- Sealed lid for airtight, weather-tight closure.
- Rigid handles make transportation easy.
- Horizontal locking handles allow for installation of LinQ Lite accessories.

- Holds thirty-four 355 ml cans.
- 5.3 US gal (20 L) capacity.
- Exterior dimensions: 21" L x 15" W x 14" H (52 cm L x 38 cm W x 35 cm H),
- Interior dimensions: 15" L x 10" W x 9" H (39 cm L x 26 cm W x 23 cm H),
- LinQ Base Installation Kit (715008125) is required for installation.
- Not compatible below the LinQ Pivoting Rack (715010786 or 715008296).

Note: Cannot be mounted on the LinQ Stackable Fuel Caddy.

LinQ Modular Box	Maverick, Maverick MAX	715005494 • (10 L) 715007112 • (20 L) 715006830 • (30 L)
-------------------------	------------------------	---



- Allows stacking of other modular boxes to always have the right gear accessible.
- Always have the right box size to fit everything.
- Can be installed on any LinQ base with a 16" width.
- See table for installation location and requirements.

Thermal Insert for LinQ Modular Box (10 L)	Maverick, Maverick MAX	219401110
---	------------------------	------------------



- Insulated liner.
- Fits very well in the LinQ Modular Box (10 L).
- Can contain seven 355 ml cans.
- Keeps ice cold for one day.
- Interior dimensions: 9" L x 17" W x 2½" H.

LinQ Tool Box	Maverick, Maverick MAX	715008111
----------------------	------------------------	------------------



- High precision injected HDPE construction provides rigidity and durability.
- 5 gal (19 L) maximum capacity.
- Weather-resistant, sealed and lockable cover.
- Easy one-second on/off tool-less system.
- All the benefits of LinQ—simple, fast and secure.
- See table for installation location and requirements.

LinQ Tool Kit	Maverick, Maverick MAX	715006829
----------------------	------------------------	------------------



- Includes:
- Cutter pliers
 - Long-nose pliers
 - Locking pliers
 - Ratchet wrench ¾" drive
 - 6" ratchet extension
 - Integrated CVT belt storage location (belt not included)
 - Long-socket 19 mm ¾" drive – 6 pts
 - Socket 18 mm ¾" drive
 - Long-socket 17 mm ¾" drive – 6 pts
 - Socket 15 mm ¾" drive
 - Socket 13 mm ¾" drive
 - Socket 10 mm ¾" drive
 - Socket 8 mm ¾" drive
 - Socket Torx T40 ¾" drive
 - Socket Torx T30 ¾" drive
 - Socket Torx T20 ¾" drive
 - Breaker bar ¾" drive
 - Combination Wrench set:
 - Wrench 19 mm
 - Wrench 18 mm
 - Wrench 15 mm
 - Wrench 13 mm
 - Wrench 10 mm
 - Wrench 8 mm
- See table for installation location and requirements.

LinQ 4.2 Gal (16 L) Cooler	Maverick, Maverick MAX	219400964 - Black 295100698 - White
-----------------------------------	------------------------	--



- All the benefits of LinQ—simple, fast and secure.
- Rotomolded construction for exceptional rigidity and durability.
- Premium-quality foam insulation for optimal ice retention.
- Uses LinQ mounting system (Patent US 8777531 and US 8875830).
- Easy one-second on/off tool-less system.
- Can contain twenty 355 ml cans.
- Keeps ice cold for three days.
- Exterior dimensions: 13" L x 20" W x 10" H.
- Interior dimensions: 9" L x 17" W x 7" H.
- See table for installation location and requirements.

NEW LinQ 5.3 US Gal (20 L) Semi-Rigid Cooler	Maverick, Maverick MAX	295101252
---	------------------------	------------------



- 5.3 US gal (20 L) of insulated, water-resistant capacity.
- Quick, easy and secure LinQ system installation.
- Attaches with one set of LinQ fasteners.
- Single-day-use soft cooler.
- Mesh pocket on top of the lid.
- Zippered pocket under the lid for quick and easy access.
- Removable interior for easy cleaning.
- Carry handles for easy transport.
- Can contain twelve 355 ml cans.
- Dimensions: 19" L x 13" W x 10" H.
- See table for installation location and requirements.

LinQ 4.5 Gal (17 L) Sport Bag	Maverick, Maverick MAX	860202447
--------------------------------------	------------------------	------------------



- All the benefits of LinQ—simple, fast and secure.
- 17 liter (4,5 US gallon) capacity.
- Thermoformed bag base in HDPE (High Density Polyethylene) providing rigidity and durability.
- Rigid bottom, semi-rigid top.
- Easy one-second on/off tool-less system.
- See table for installation location and requirements.

SR 5.5 Gal (21 L) LinQ Bag	Maverick, Maverick MAX	860202449
-----------------------------------	------------------------	------------------



- All the benefits of LinQ—simple, fast and secure.
- Semi-rigid expandable bag.
- 5.5 gal (21 L) capacity.
- Utilizes LinQ mounting system (Patent US 8777531 and US 8875830).
- Easy one-second on/off tool-less system.
- See table for installation location and requirements.

LinQ Roll-Top Bag	Maverick, Maverick MAX	715008110
--------------------------	------------------------	------------------



- Fully waterproof roll-top dry bag will securely store and confine your equipment.
- LinQ mounted using heavy-duty rigid plastic base.
- High capacity storage solution (40 L).
- Bottom foam liner for additional equipment protection.
- Integrated handle for easy transportation on/off the vehicle.
- Dimensions: 14" L x 19" W x adjustable H.
- See table for installation location and requirements.

LinQ ACCESSORIES WITH 36" BASE

LinQ 12 Gal (45 L) Cargo Box	Maverick, Maverick MAX	715003879
-------------------------------------	------------------------	------------------



- LinQ mounted for easy-on, easy-off installation.
- Holds cargo safely and securely while riding.
- See table for installation location and requirements.

LinQ 23 Gal (86 L) Trunk Box	Maverick (except X mr models), Maverick MAX	715004923
-------------------------------------	--	------------------



- LinQ mounted for easy-on, easy-off installation.
- Holds cargo safely and securely while riding.
- See table for installation location and requirements.

LinQ 32 Gal (121 L) Trunk Box	Maverick (except X mr models), Maverick MAX	715001748 • (No rear tail light)
--------------------------------------	--	---



- Equipped with the LinQ system, the rear trunk box plugs in and out in seconds.
- 32 gal (121 L) load capacity with unobstructed space to maximize storage room and access to the trunk's interior.
- Made of injection-molded polyethylene, double walled in critical areas.
- The fully sealed lid protects your belongings from dust, moisture and the elements.
- No rear tail light.
- Trunk Box Panels available in many colors to match your vehicle (sold separately).
- See table for installation location and requirements.

LinQ 32 Gal (121 L) Trunk Box Panels	Fit with LinQ 32 Gal (121 L) Trunk Box EUROPEAN VERSION (EC compliant)
---	---



- Color panels to match the LinQ 32 gal (121 L) Trunk Box to your vehicle.
- No rear tail light

715001397 • Black
 715001398 • Yellow
 715002483 • White

715006121 • Can-Am Red
 715006123 • Orange Crush
 715006124 • Viper Red

LinQ 8 Gal (30 L) Cooler Box	Maverick, Maverick MAX	715004778 • Black
-------------------------------------	------------------------	--------------------------



- LinQ mounted for easy-on, easy-off installation.
- Rotomolded construction provides exceptional rigidity and durability.
- Premium-quality foam insulation for optimal ice retention.
- Integrated, fully removable compartment protects food.
- Robust rubber latches keep the cover tightly closed.
- Weather-resistant.
- Convenient drain plug.
- See table for installation location and requirements.

LinQ 11.5 Gal (43 L) Audio Cargo Box	Maverick, Maverick MAX	715003018
	<ul style="list-style-type: none"> • An affordable and quick solution for adding music and storage to your next ride. • The rear installation does not use up any cab space and allows easy listening at an average speed. • Mounts on/off easily to hold/carry cargo safely and securely. • Backlit control panel perfect for night riding. • Water-resistant speakers. • The Bluetooth[®] enabled receiver and 6.5" (16.5 cm) speakers are smartly concealed and integrated in the cover. • Automatic shut-off function protects your battery by turning the system off after 10 minutes of inactivity. • See table for installation location and requirements. 	

LinQ Heavy-Duty Basket	Maverick, Maverick MAX	715001215
	<ul style="list-style-type: none"> • Made of high-strength, low-alloy steel. • LinQ mount for easy-on, easy-off installation. • See table for installation location and requirements. 	

LinQ Premium Storage Bag by OGIO	Maverick, Maverick MAX	715002923 - Black
	<ul style="list-style-type: none"> • Tool-less installation and removal thanks to the LinQ system. • 17.2 gal (65 L) capacity semi-rigid cargo bag ideal for carrying anything you need on your vehicle. • Buckle and elastic closure with a rubber seal that prevents dust from entering the bag. • 3-section lid for partial or full access to your bag. • Inside separators for optimal bag organization. • See table for installation location and requirements. 	

LinQ Low Profile Basket	Maverick, Maverick MAX	715004282
	<ul style="list-style-type: none"> • Low profile, open basket increases cargo space. • Perfect for easy access to tools, rope, winch and plow accessories. • Multiple bungee cord and tie-down anchor points. • Made of impact-resistant injected polypropylene. • See table for installation location and requirements. 	

LinQ HOLDERS

NEW LinQ Lite Action Camera Holder	Maverick, Maverick MAX 2026	295101139
	<ul style="list-style-type: none"> • LinQ Lite attachment system for cameras. • Provides great vantage points to capture photos and videos. • Offers 360-angle positioning for perfect filming and taking photos. • Designed to hold devices securely. • Fast, easy attachment and removal. 	

NEW LinQ Lite Device Holder	Maverick, Maverick MAX 2026	715009201
	<ul style="list-style-type: none"> • Made with strong magnets that you can trust while riding through rough terrain • Includes everything needed for installation on your favorite electronic devices: 2 pre-assembled Can-Am plates with 3M multi-surface adhesive. • 360° adjustment for an improved driving experience and immersion. • Secure LinQ Lite attachment allows you to install/remove the holder in seconds. • Robust plastic and aluminum construction allows for the right fit and easy installation. • Compatible with the Cellphone Holder (715008786). • To keep a good vision while driving, we recommend using this device for smartphones only. 	

LinQ Tool Holder	Maverick, Maverick MAX	715007358
	<ul style="list-style-type: none"> • Ultra-versatile tool holder. • Convenient swivel-latch allows tools to be stored in any orientation. • Sold in pairs. 	

LinQ Gear Grips

Maverick, Maverick MAX

715005340



- Durable and flexible grips provide a custom fit for a variety of items from 1" to 4" (2,5 cm to 10 cm) in diameter.
- Heavy-duty design for carrying bows, fishing poles, rakes, farm tools and more.
- Quick-release button opens grip quickly for easy access to gear.
- Heavy-duty base system built for the toughest adventures.
- Make transporting your tools a snap by combining the LinQ Gear Grips with the LinQ system.
- 360° orientation.
- Sold in pairs.

LinQ MOUNTING

LinQ Anchor Adapter Kit

Maverick, Maverick MAX

715004960



- Allows the installation of LinQ accessories with 16" base on LinQ racks.
- Tool-less installation and removal.

LinQ Base Installation Kit

Maverick, Maverick MAX

715008125



- Allows installation of compatible LinQ accessories.
- Included: 2 LinQ Cargo bases and hardware.

LinQ Lock

Maverick, Maverick MAX

860201968



- Simple way to securely lock most LinQ accessories.
- Lock cover protects lock from the elements.
- Corrosion resistant.
- Pack of 1, includes 2 keys.
- Not compatible with LinQ 4.2 US Gal (16 L) Cooler, LinQ Tool Box, LinQ Tool Holder or LinQ Gear Grips.

LinQ Replacement Part

Maverick, Maverick MAX

715010798



- Unique mounting fastener usable on any LinQ system accessory.
- Tool-less installation and removal.
- Sold in pairs.

LinQ Adapter

Maverick MAX

715003058



- Allows the installation of the LinQ Tool Holder on the Adventure Roof Rack.
- Sold in pack of 4.

Cargo Box Net

Maverick, Maverick MAX

715001371



- Solid net designed to secure and ensure the compact confinement of your Adventure Roof Rack.

Spare Tire Ratchet Tie-Downs

Maverick, Maverick MAX

280000955



- 3-way ratcheting tie-down strap with loop ends.
- Designed to securely hold spare tires on accessories equipped with integrated spare tire attachment points.
- Adjustable to accommodate most common UTV tire sizes.
- Ratchet and junction ring made of durable zinc-plated steel.
- Required for spare tire attachment on Adventure Roof Rack.

RACKS & STORAGE

RACKS

LinQ Pivoting Rack

Maverick, Maverick MAX (except X mr models and X rc with Smart-Shox)

■ **715010786** - Black
 ■ **715008296** - Can-Am Red



- LinQ latched rack allows for extra LinQ mounted accessories or for carrying a spare tire (tire not included).
- Includes custom tie-down strap for fast spare tire installation or removal (tire not included).
- Gas-cylinder pivot action, locks in the raised position.
- Trunk Boxes over 20 gal (74 L) do not fit on the vehicle when the rack is installed.
- Not compatible with Rear Intrusion Bars, Rear Cage Extension and Lonestar Racing Aluminum Roofs.
- Not compatible with snorkel and rad relocater.

Adventure Roof Rack

Maverick
Maverick MAX

715006225
715003868



- Ideal cargo solution for packing everything you need to live your Off-Road experience fully and completely.
- Built with lightweight 1.25" (3.2 cm) diameter steel tubing.
- Integrated mounting points for lights can hold up to eight pod-type LED lights (six front and two back) or a 40" (102 cm) LED bar (front).
- Features anchor points for spare-tire attachment.
- LinQ anchor on both sides.
- Spare Tire Tie-Downs sold separately.
- Add the Cargo Box Net to secure and confine your cargo in the rack.
- Loads up to 75 lb (34 kg).

Adventure Roof Rack

Maverick
Maverick MAX

715007186
715008073



- The ideal cargo solution. Pack all the gear you need to take on any off-road experience.
- Built using lightweight 1.25" (3.2 cm) diameter steel tubing.
- Supports loads of up to 75 lb (34 kg).
- This roof rack features a height adjustment setting to precisely accommodate a stock roof.
- Integrated mounting points for lights.
- Features anchor points for a spare tire attachment.
- LinQ anchor on both sides.
- The Spare Tire Tie-Downs sold separately.
- Sport Roof or Aluminum Roof is required for installation.

STORAGE

Passenger Storage Seat Bag

Maverick, Maverick MAX

715008080



- This weather-resistant bag holds your gear safely and securely while you ride.
- Bag settling on the passenger's seat to increase the vehicle's cargo capacity.
- This bag features a 14.5 gal (55 L) storage capacity and is divided into two compartments.
- The top compartment is insulated to keep your beverages cold and includes two cup holders.
- Additional pocket inside for additional storage, such as a cell phone.
- The bottom compartment is accessible from both sides and serves as a large pocket for storing various items.
- The detachable pocket at the front of the bag can be used as a garbage bag.

Shoulder Storage Bag

Maverick (except X mr models),
Maverick MAX (rear only)

715004277



- Bag attaches in unused space between the seats to increase your vehicle's cargo capacity.
- Installs between the rear seats only on MAX models.

Front Shoulder Storage Bag

Maverick MAX

715004888



- Opens on each side so that both front and rear passengers can access the bag's content.
- Installs between the driver's and passengers' seats on MAX models.

Overhead Storage Bag

Maverick, Maverick MAX

715004275



- Weather-resistant bag, holds your gear safely and securely while riding.
- Makes smart use of your overhead space to increase your vehicle's cargo capacity by 2.6 gal (10 L).
- Semi-rigid construction renders it flexible enough to fit odd-shaped loads.
- Touchscreen-compatible clear front pocket allows for easy access to your smartphone.
- Not compatible with the Bimini Roof.

Upper Door Storage Bags

Maverick, Maverick MAX

715004276



- Weather-resistant, they'll hold your gear safely and securely while riding.
- Bags attach on stock quarter doors to increase your vehicle's cargo space.
- Each bag is designed as a 1.3 gal (5 L) capacity pocket also equipped with inner netting compartments.
- Semi-rigid construction renders them flexible enough to fit odd-shaped loads.
- Sold in pairs.

Lower Door Panel Storage Bags

Maverick, Maverick MAX

715004355



- Weather-resistant, they'll hold your gear safely and securely while riding.
- Bags attach on Lower Door Panels to increase your vehicle's cargo space.
- Each bag is designed as a 1.6 gal (6 L) capacity pocket also equipped with inner netting compartments.
- Semi-rigid construction renders them flexible enough to fit odd-shaped loads.
- Sold in pairs.
- Not compatible with Aluminum Half Doors.
- Lower add-on doors required for installation.

Soft Storage Bag

Maverick, Maverick MAX

715003759



- 11.8 gal (45 L) capacity soft cargo bag designed with vehicle's rear in mind to maximize potential storage.
- 3 sections.
- Weatherproof.

Storage 2.6 Gal (10 L) Bag

Maverick, Maverick MAX

269502121



- Roll-top dry bag for fully protecting your cargo from the elements.



SMART ACCESSORIES

Powered by the ACM, SMART Accessories respond automatically to speed, steering, and other sensor data, adjusting light output, behavior, and function in real time.

A RESPONSE SYSTEM THAT TAKES TECH TO THE NEXT LEVEL.

ACM

This is the brain of the SMART Ecosystem. It reads multiple sensors on the vehicle and translates the reading into actions for the accessories.



10.25" TOUCHSCREEN DISPLAY

When your vehicle is equipped with the 10.25" touchscreen display, it allows you to control up to 19 accessories at the same time.



SMART CONTROL CENTER

Allows you to quickly access SMART Accessories (can be used with or without the 10.25" touchscreen display).



SMART ACCESSORIES

Accessories designed to execute multiple functions depending on the input from the ACM.



ACM & SMART ACCESSORIES

ACCESSORY CONTROL MODULE (ACM)

NEW Accessory Control Module

Maverick, Maverick MAX (with touchscreen display)

715010097



- Bringing the SMART to accessories using live vehicle ECU information to maximize your accessory experience.
- Connect your accessories to the 10.25" Color Touchscreen Display.
- Easy accessory installation (plug and play).
- Creates an ecosystem that makes installing accessories quicker and easier.
- Includes ACM Front Harness to connect front-mounted SMART accessories to the Accessory Control Module (two auxiliary connectors available).

NEW Rear ACM Harness

(Not illustrated)

Maverick, Maverick MAX (with touchscreen display)

715009268

- Required to connect rear-mounted accessories and rear chase lights to the ACM.
- Creates an ecosystem that makes installing accessories quicker and easier.
- Five auxiliary connectors are available.

NEW SMART Control Center for ACM

Maverick, Maverick MAX (with touchscreen display)

715010834



- Control the accessories with the selection of different modes, the illuminated halo around the button indicates the active mode.
- Icons illuminate when accessories are activated.
- Make accessory control changes without having to take your eyes off the trail by choosing the accessory button required (quick access).
- All Front LED Off button to turn off all front lights with one click. Remembers the last programmed setups when this button is pressed again.
- 6 pre-programmed buttons (Light Bars, PowerFlip Windshield, All Front LED Off, Corner Lights) and 10 programmable buttons to customize according to the accessories installed.
- Requires Accessory Control Module.

SMART ACCESSORIES

NEW SMART Integrated LED Roof Light

Maverick, Maverick MAX (2020 & up)

715010102



- Mounted under the roof for a signature look.
- Windshield compatible except with the PowerFlip.
- Intensity varies (increases or decreases) according to the speed of the vehicle with the installation of the Accessory Control Module (ACM) (Spot/Flood ratio).
- Spot/Flood combo beam.
- 22,100 lumens.
- Off/Low/High (switch activated).
- Off/Low/High/SMART Automatic Mode (Accessory Control Module (ACM) activated).
- Accessory Control Module (715010097) is required for SMART functionality.
- Integrated LED Roof Light Wiring Harness (715008209) is required for on/off function when ACM is not installed. Sold separately.
- Not compatible with PowerFlip Windshield (715007097).
- ECE Certified

NEW SMART 10" (25 cm) LED Light Bar

Maverick, Maverick MAX

715008745



- The perfect combination of powerful white and selective yellow LEDs.
- The selective yellow LEDs are ideal for driving in low visibility conditions.
- The light is composed of 16 white LEDs and 8 yellow LEDs.
- Spot and Flood combo beam.
- The side lens design provides highly effective wide-angle illumination.
- The white LEDs produce 8,100 raw lumens and the selective yellow 2,640 raw lumens, delivering stunning lighting performance.
- The lens is made from hard-coated polycarbonate.
- IP67 and IP69k submersible and pressure washer safe.
- Switch options: Off, Low and High, Color change by flicking the switch quickly.
- SMART options: Off, Low, High, color change and SMART Automatic Mode.
- SMART MODE: Intensity increases or decreases and Spot/Flood ratio varies according to the speed of the vehicle with the installation of the Accessory Control Module (ACM).
- Accessory Control Module (715010097) is required for SMART functionality.
- Wiring Harness (715009886) is required for on/off function when ACM is not installed. Sold separately.
- Just a heads-up, you'll need a bumper for this.
- ECE Certified

NEW SMART 40" (102 cm) LED Light Bar

Maverick, Maverick MAX

715008747



- The perfect combination of a powerful white or selective yellow LEDs.
- The selective yellow LEDs are ideal for driving in low visibility conditions.
- The light is composed of 64 white LEDs and 32 yellow LEDs.
- Spot and Flood combo beam.
- The side lens design provides highly effective wide-angle illumination.
- The white LEDs produce 32,000 raw lumen, and the selective yellow 10,560 raw lumens, delivering stunning lighting performance.
- The lens is made from hard-coated polycarbonate.
- IP67 and IP69k submersible and pressure washer safe.
- Switch options: Off, Low and High. Color change by flicking the switch quickly.
- SMART options: Off, Low, High, color change and SMART Automatic Mode.
- SMART MODE: Intensity increases or decreases and Spot/Flood ratio varies according to the speed of the vehicle with the installation of the Accessory Control Module (ACM).
- Accessory Control Module (715010097) is required for SMART functionality.
- See table for installation location and requirements.
- ECE Certified

NEW SMART LED Chase Lights

Maverick, Maverick MAX

715007727



- Designed by Can-Am to make you visible to vehicles riding behind you, especially in dusty or harsh conditions.
- Four modes available:
 - Trail Mode: serves as a taillight and as a brake light.
 - Chasing Mode: displays amber light pattern and serves as a brake light.
 - Work Mode: White light to light up your cargo bed.
 - Reverse Mode (when connected with Accessory Control Module (ACM)): serves as a back up light.
- Modular to allow installation with rear roll cage mounted accessories.
- Plug-and-play installation with the Accessory Control Module (ACM).
- Accessory Control Module (715010097) and Rear ACM Harness (715009268) are required for SMART functionality.
- Wiring harness required for a non-smart function when ACM is not installed. Sold separately.
- ECE Certified

Integrated LED Side Mirror Lights

Maverick, Maverick MAX

715007185



- Light up corners.
- Increase the width of the beams and illuminate the wheels for increased visibility.
- Wide flood beam.
- 3,000 lumens for each light.
- Left and right dynamic lighting with Accessory Control Module (ACM) install. Follow steering wheel input.
- Accessory Control Module (715010097) is required for SMART functionality.
- Require Aluminum Side Mirrors (715007363).
- Electric Harness required (715008212) to hook up and operate the Integrated LED Side Mirror Lights for on/off function when ACM is not installed. Sold separately.

LIGHTS

CAN-AM LIGHTS WITH ACM

		2 CHOOSE YOUR LIGHTS					
1 CHOOSE YOUR MOUNT POINT		SMART Integrated LED Roof Light 715010102	SMART Integrated LED Side Mirror Lights 715007185	SMART LED Chase Lights 715007727	SMART 40" (102 cm) LED Light Bar 715008747	SMART 10" (25 cm) LED Light Bar 715008745	
SMART FUNCTIONALITY	Vehicle Integrated	Accessory Control Module 715010097	Aluminum Side Mirrors 715007363 + Accessory Control Module 715010097	Accessory Control Module 715010097 + Rear ACM Harness 715009268	No compatibility	No compatibility	
	Front Bumper (except XMR/XRC and Lonestar)	No compatibility				Accessory Control Module 715010097	Accessory Control Module 715010097
	Sport Roof with Light Support Bar 715003529						No compatibility
	Audio Roof (no additional bracket needed)					No compatibility	
	Adventure Roof Rack 715006225, 715003868, 715007186					No compatibility	

CAN-AM LIGHTS WITHOUT ACM

		2 CHOOSE YOUR LIGHTS				
1 CHOOSE YOUR MOUNT POINT		SMART Integrated LED Roof Light 715001012	SMART Integrated LED Side Mirror Lights 715007185	SMART LED Chase Lights 715007727	SMART 40" (102 cm) LED Light Bar 715008747	SMART 10" (25 cm) LED Light Bar 715008745
ON/OFF FUNCTIONALITY	Vehicle Integrated	Wiring Harness 715008209	Aluminum Side Mirrors 715007363 + Wiring Harness 715008212	Wiring Harness 715008210	No compatibility	No compatibility
	Front Bumper (except XMR/XRC and Lonestar)	No compatibility				Lights Wiring Harness 715009886
	Sport Roof with Light Support Bar 715003529	No compatibility				No compatibility

		2 CHOOSE YOUR LIGHTS									
1 CHOOSE YOUR MOUNT POINT		BAJA DESIGNS ⁺ LIGHTS					CAN-AM LIGHTS				
		10" (25 cm) LED Light Bar	40" (102 cm) Baja Design OnX6 Arc LED Light Bar	XL Sport LED Lights (sold in pairs)	Squadron Sport LED Lights (sold in pairs)	XL80 LED Lights (sold in pairs)	10" Double Stacked LED Bar	15" Double Stacked LED Bar	39" Double Stacked LED Bar	4" Round LED Lights (sold in pairs)	3.5" Spot or Flood LED Lights (sold in pairs)
Front Pre-runner or Dune Bumpers	710006819 + 715007049 (Power Cable)	710006818 + 715008864 (Power Cable)	710006821 + 715008865 (Power Cable)	710006820 + 715008865 (Power Cable)	710005041 + 715007049 (Power Cable)	715002933 + 715003417 (Power Cable)	No compatibility	715002934 (Not compatible with Pre-runner Bumper) + 715003417 (Power Cable)	No compatibility	715002935 (4" Round), 715010093 (3.5" Flood) or 715010094 (3.5" Spot) + 715003417 (Power Cable)	
Lonestar Racing Front Bumper	NA	710006821 + 715008865 (Power Cable)	710006820 + 715008865 (Power Cable)	710005041 + 715007049 (Power Cable)	No compatibility						
Light Support Bar or Adventure Roof Rack	NA	710006818 + 715008864 (Power Cable)	710006821 + 715008865 (Power Cable)	710006820 + 715008865 (Power Cable)	710005041 + 715007049 (Power Cable)	NA	715002934 + 715003417 (Power Cable)	715004007 + 715005822 (Light Mounting Kit)			
Lonestar Racing 40" (102 cm) LED Light Bar Rack	710006818 + 715008864 (Power Cable)	NA	NA	NA	NA		NA	NA	NA	NA	NA
Lonestar Racing Light Rack	NA	710006821 + 715008865 (Power Cable)	NA	710005041 + 715007049 (Power Cable)	NA		NA	NA	NA	NA	NA

3 ORDER **ORDER ALL PART NUMBERS IN INTERSECTING BOX**
 *Note: When installing more than one light kit, additional light power cable or mounting kit is required.

*All lights are intended for off-road use only.

40" (102 cm) Baja Designs OnX6 Arc LED Light Bar

Maverick, Maverick MAX

710006818



29,000 lumens

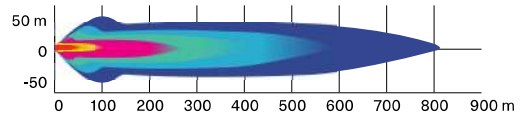

- 252 W light bar producing 29,000 lumens.
- Equipped with 24 Cree XM-L2 LEDs.
- Driving/combo light pattern for smooth blend of light for both near field applications and distance.

- Designed for installation onto Light Support Bar equipped roofs.
- Requires Light Power Cable and Light Support Bar.
- See table for installation location and requirements.

Baja Designs 10" (25 cm) OnX6 LED Light Bar

Maverick, Maverick MAX

710006819



12,460 lumens

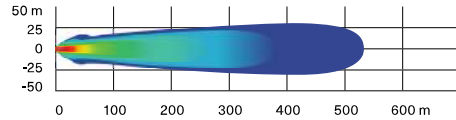

- 108 W light bar producing 12,460 lumens.
- Equipped with 6 Cree XM-L2 LEDs.
- Driving/combo light pattern for smooth blend of light for both near field applications and distance.

- Dual intensity (high/low) settings.
- Requires Baja Designs Light Power Cable.
- See table for installation location and requirements.

Baja Designs XL80 LED Lights

Maverick, Maverick MAX

710005041



9,500 lumens

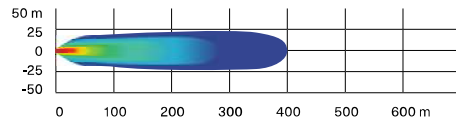

- 80 W per spot producing 9,500 lumens.
- Equipped with 4 Cree XHP50 LEDs per spot.
- Dual intensity (high/low) settings.
- Driving/combo light pattern for smooth blend of light for both near field applications and distance.

- Require Baja Designs Light Power Cable.
- Sold in pairs.
- Dimensions: 4.5" x 4.5" (11.4 cm x 11.4 cm).
- See table for installation location and requirements.

Baja Designs Squadron Sport LED Lights

Maverick, Maverick MAX

710006820



3,150 lumens

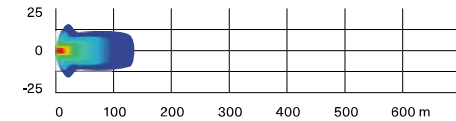

- 26 W per spot producing 3,150 lumens.
- Equipped with 4 Cree XP-G2 LEDs per spot.
- Wide cornering light pattern designed specifically for cornering, dust and/or fog conditions.

- Require Baja Designs Light Power Cable.
- Sold in pairs.
- Dimensions: 3" x 3" (7.6 cm x 7.6 cm).
- See table for installation location and requirements.

Baja Designs XL Sport LED Lights

Maverick, Maverick MAX

710006821



3,150 lumens

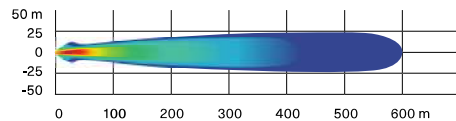

- 26 W per spot producing 3,150 lumens.
- Equipped with 4 Cree XP-G2 LEDs per spot.
- High Speed Spot features a longer and narrower beam focus for illumination farther down.

- Require Baja Designs Light Power Cable.
- Sold in pairs.
- Dimensions: 4.5" x 4.5" (11.4 cm x 11.4 cm).
- See table for installation location and requirements.

Lights Power Cable

(Not illustrated)

Maverick, Maverick MAX

715003417

715007049

715008865

715008864

- Required for installation of Baja Designs LED lights onto roof or bumper.
- 10" (25 cm) Baja Designs OnX6 LED Bars and Baja Designs XL80 LED Lights (715007049).
- Baja Designs XL Sport LED Lights and Baja Designs Squadron Sport LED Lights (715008865).
- 40" (102 cm) Arc LED Light Bar ONX6 (715008864).

10" (25 cm) Double Stacked LED Light Bar (60 W)

Maverick, Maverick MAX

715002933



5,400 lumens

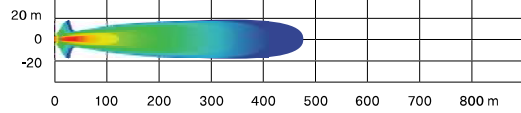

- Equipped with twelve 5 W Cree LEDs.
- 5,400 lumens.
- Packs a big punch for its size.
- Rugged and waterproof.
- Requires light power cable for installation.

- Lights up to more than 1,500 ft. (460 m) in front of the vehicle and around 65 ft. (20 m) wide on each side.
- ECE Certified.
- See table for installation location and requirements.

15" (38 cm) Double Stacked LED Light Bar (90 W)

Maverick, Maverick MAX

715002934



8,400 lumens

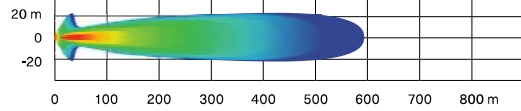

- Equipped with 18 5 W Cree LEDs.
- 8,400 lumens.
- Complements the Light Racks and most bumpers.
- Rugged and waterproof.

- Lights up to more than 1,900 ft. (580 m) in front of the vehicle and around 65 ft. (20 m) wide on each side.
- ECE Certified.
- See table for installation location and requirements.

39" (99 cm) Double Stacked LED Light Bar (270 W)

Maverick, Maverick MAX

715004007



24,300 lumens

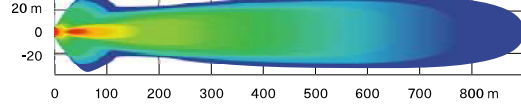

- Equipped with 54 5 W Cree LEDs.
- 24,300 lumens.
- Lights up to more than 2,900 ft. (900 m) in front of the vehicle and around 115 ft. (35 m) wide on each side.

- Compatible with the Adventure Roof Rack.
- Requires light power cable for installation.
- Not ECE Certified

4" (10 cm) Round LED Lights (2 x 25 W)

Maverick, Maverick MAX

715002935



1,800 lumens

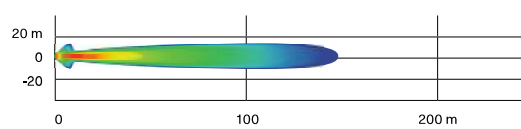

- 25 W LED spotlights.
- Rugged and waterproof.
- Includes basic wiring and switch.

- Can-Am branded grill.
- Requires light power cable.
- Sold in pairs.
- Not EC compliant.
- Requires light power cable for installation.

3.5" (9 cm) LED Driving Lights (2 x 14 W)

Maverick, Maverick MAX

715010094



1,260 lumens

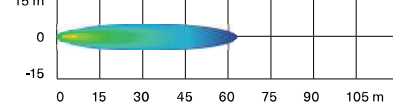

- 14 W LED lights producing 1,260 lumens each.
- Spot lens for a narrow and long light beam spread, ideal when driving at higher speeds.
- Equipped with six high-power LEDs in a heavy-duty die-cast aluminum housing.

- Features two attachment points. If one attachment point fails due to a collision, rotate to the next channel point and remount the light.
- Sold in pairs.
- ECE Certified
- Requires light power cable for installation.

3.5" (9 cm) LED Flood Lights (2 x 14 W)

Maverick, Maverick MAX

715010093

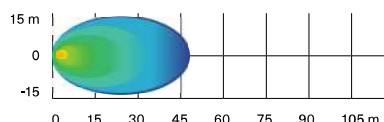

- 14 W LED lights producing 1,260 lumens each.
- Flood lens for a wide light beam spread, ideal for working applications like plowing or cornering. Suitable for dusty or foggy riding conditions.
- Equipped with six high-power LEDs in a heavy-duty die-cast aluminum housing.

- Features two attachment points. If one attachment point fails due to a collision, rotate to the next channel point and remount the light.
- Sold in pairs.
- ECE Certified.
- Requires light power cable for installation.

Can-Am LED Signature Lights

Maverick, Maverick MAX

715003673



- Add style with a more aggressive look.
- Use bright and energy efficient LEDs.
- Do not give additional lighting for driving.

NEW Dome Light

Maverick, Maverick MAX

715009228



- Offers an optimal visibility in the cab and integrates perfectly with the vehicle.
- 160 lumens of soft white light ensure clear visibility of the surroundings.
- Built in on/off button on the light.
- Wiring included.
- Can be installed on cage, Sport Roof or All-Terrain Trunk Cover.
- Not compatible with Audio Roof.

Lonestar Racing 40" (102 cm) LED Light Bar Rack

Maverick, Maverick MAX

715003920



- Designed for use with 40" (102 cm) Baja Designs OnX6 Arc LED Light Bar.
- Enhances the vehicle's race-inspired look.
- Compatible with Aluminum Roof, Lonestar Racing Aluminum Roof and Sport Roof.
- Not compatible with Racing Side Mirrors and PowerFlip Windshield.
- Lights sold separately.

Lonestar Racing Light Rack

Maverick, Maverick MAX

715003948



- Designed for use with Baja Designs XL80 LED Light and Baja Designs XL Sport LED Light.
- Accommodates up to two pairs of XL Lights.
- Not compatible with Racing Side Mirrors and PowerFlip Windshield.
- Compatible with Lonestar Racing Aluminum Roof, Aluminum Roof and Sport Roof.
- Lights sold separately.

Chase Lights

Maverick, Maverick MAX

715002887



- Designed by Can-Am to make you visible to vehicles riding behind you, especially in dusty or harsh conditions.
- Feature in-dash switches to activate one of the two modes and to choose among 11 different high-visibility colored light patterns (blue, red and yellow).
- Trail Mode: Serves as a tail light and as a brake light.
- Chasing Mode: Displays amber and blue light patterns and serves as a brake light (brake light function can be deactivated for racing applications).
- Modular to allow installation with rear roll cage mounted accessories.
- Plug-and-play installation.
- Verify your local regulations concerning the use of blue lighting.

LED Chase Lights

Maverick, Maverick MAX

715009887



- Designed by Can-Am to make you visible to vehicles riding behind you, especially in dusty or harsh conditions.
- High-visibility colored light patterns (red, yellow, white).
- Three modes available:
 - Trail Mode: serves as a tail light and as a brake light.
 - Chasing Mode: displays amber light pattern.
 - Work Mode: white light to light up your cargo bed.
- Modular to allow installation with rear roll cage mounted accessories.
- Plug-and-play installation.
- Wiring Harness required (715008210). Sold separately.
- Can be installed with roof scoop but only with the lateral light.

Light Support Bar	Maverick, Maverick MAX	715003529
	<ul style="list-style-type: none"> Sleekly styled rugged aluminum construction. Accommodates light bars and spotlights with or without any roof and windshield combination. Full vehicle width to allow the installation of any large LED light bar. 	<ul style="list-style-type: none"> Required for light installation on vehicle's roof. Not compatible with Lonestar Racing Aluminum Roof. Lights sold separately.

Mounting Kit for 39" (99 cm) LED Light Bar <i>(Not illustrated)</i>	Maverick, Maverick MAX	715005822
	<ul style="list-style-type: none"> Required for installation of the 39" (99 cm) double stacked LED Light Bar. Includes wiring and support bracket. Light Support Bar required for installation. 	

NEW Lights Wiring Harness	Maverick, Maverick MAX	715009886
	<ul style="list-style-type: none"> Power cable for installation of the SMART 10" (25 cm) LED Light Bar (715008745). 	

Light Power Cable <i>(Not illustrated)</i>	Maverick, Maverick MAX	715003417
	<ul style="list-style-type: none"> Required for installation of 10" (25 cm), 15" (38 cm) and Double Stacked LED Light Bars and 4" (10 cm) Round LED Lights. For bumper and roof mounting locations. 	



YOUR SOUND, YOUR WAY

Choose the audio setup that matches your style.

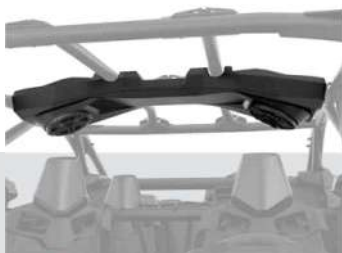

MTX CENTRAL SPEAKERS

This option includes a top mounted central speaker case with two 6.5" 100-watt speakers PLUS a 10" under-seat 250-watt amplifier.



AUDIO ROOF

This option includes a full roof with four or six 8" speakers, one 400 RMS, and an 800 peak watt amplifier supplied by Rockford Fosgate audio.



COMPLETE MTX AUDIO SYSTEM

This option includes front-dash-board and rear-roll-cage mounted stereo speakers and head unit with an integrated 6.5" subwoofer.

LEVEL UP WITH UPGRADES

Bring the thunder wherever you roll with an amplifier or a subwoofer for even bigger sound on every ride.

AUDIO & COMMUNICATION SYSTEMS

AUDIO

Can-Am Rockford Fosgate Audio Roof – Level 4	Maverick (with touchscreen display) Maverick	715010098 NEW 715007130
	<ul style="list-style-type: none"> • Full roof with sleek built-in audio. • Fully sealed and waterproof. • Easy to install: one wire connects the roof to the vehicle's electronics. • Four 8" speakers, one 400 RMS and 800 peak watt amplifier calibrated by Rockford Fosgate Audio. • Multi-colored RGB LED accent lighting around each speaker. 	<ul style="list-style-type: none"> • 2.7" color display with Bluetooth and Pandora connectivity (715007130). • Controlled by the 10.25" Color Touchscreen Display (715010098). • Flip Kit-compatible. • Not compatible with the Adventure Roof Rack if the Flip Kit is installed. • Not compatible with the Upper Soft Door Panels.
Can-Am Rockford Fosgate Audio Roof MAX – Level 4	Maverick MAX (with touchscreen display) Maverick MAX	715010099 NEW 715006709
	<ul style="list-style-type: none"> • Full roof with built-in audio. • Fully sealed and waterproof. • Easy to install, one wire connects the roof to the vehicle's electric system. • Six 8" speakers, one 400 RMS and 800 peak watt amplifier calibrated by Rockford Fosgate Audio. • Multi-colored RGB LED accent lighting around each speaker. 	<ul style="list-style-type: none"> • 2.7" color Display with Bluetooth and Pandora connectivity (715007130). • Controlled by the 10.25" Color Touchscreen Display (715010099). • Not compatible with the Adventure Roof Rack if the Flip Kit is installed. • Not compatible with the Upper Soft Door Panels.
Can-Am Audio Roof Flip Kit	Maverick, Maverick MAX	715007131
	<ul style="list-style-type: none"> • Combines with Audio Roof (715007130 or 715006709) for Flip option. • Not compatible with the Racing Side Mirrors (715002898). 	
MTX Central Speakers	Maverick MAX	715004748
	<ul style="list-style-type: none"> • Top mounted central speaker case holding two 6.5" (16.5 cm)/100 W speakers. • Designed to be Can-Am-tough in the most demanding riding conditions. 	<ul style="list-style-type: none"> • Perfect add-on to the Complete MTX Audio System for a 7-speaker system or as a stand-alone system by plugging the AUX input jack directly into your music device. • Not compatible with Lonestar roofs.
Complete MTX Audio System	Maverick, Maverick MAX	715002873
	<ul style="list-style-type: none"> • Bluetooth 5¹ equipped 400 W RMS/800 W peak audio system by MTX. • Designed to be Can-Am-tough in the most demanding riding conditions. 	<ul style="list-style-type: none"> • Includes front-dashboard and rear-roll-cage mounted stereo speakers and head unit with an integrated 6.5" (16,5 cm) subwoofer. • Add the Electronic Device Holder to securely hold your Bluetooth device ready to play your favorite tunes.
Can-Am Subwoofer	Maverick, Maverick MAX	715004956
	<ul style="list-style-type: none"> • Powerful Rockford Fosgate Underseat 10" Subwoofer speaker box. • Easy plug-and-play connections to Audio Roof system. • Sturdy construction tough enough to withstand harsh environments and sealed against moisture and dirt. 	<ul style="list-style-type: none"> • Requires 1 Amplifier Kit (715007227) for 1 or 2 subwoofers. • Fits two per vehicle: under driver's or passenger's seat.
Can-Am Amplifier Kit	Maverick, Maverick MAX	715007227
	<ul style="list-style-type: none"> • A powerful 400 W amplifier to feed up to two Underseat Subwoofers. • Easy plug-and-play connections to Audio Roof system and subwoofer. • Installation plate and wiring included. 	
Electronic Device Holder	Maverick, Maverick MAX	715002874
	<ul style="list-style-type: none"> • A great in-ride entertainment system platform. • Robust injected-polypropylene construction allows for right fit and easy installation. • Adjustable unit safely holds most tablets and smartphones measuring between 5.1" (13 cm) and 10" (25,4 cm) (with protective case). 	<ul style="list-style-type: none"> • Combines seamlessly with Complete MTX Audio System and Rugged Radios Intercom System. • Allows the installation of Garmin Montana 680T GPS. • Integrated storage (1 gal [3,8 L] capacity) with access to the dash 12V outlet for device charging.

ELECTRICAL & ELECTRONIC ACCESSORIES

ELECTRICAL

Seat Heater	Maverick, Maverick MAX	715006112
	<ul style="list-style-type: none"> • 25 W seat heater delivers chill-free riding comfort. • High/low temperature settings allow you to control the desired degree of warmth. • This kit includes one carbon fiber seat heater, foam sheet and in-dash switch. • Installs directly in the original seat cushion. • Heated Accessories Wiring Harness (710005757) is required for front seat installation. • Heated Accessories Wiring Harness (715006004) is required for rear seat installation. 	

Heated Visor Outlet	Maverick, Maverick MAX	715001246
	<ul style="list-style-type: none"> • Strategically positioned on vehicle to maintain your agility. • Optional visor outlet that delivers fog-free riding. • Quick and easy installation. • Sold individually. • Heated Visor not included. 	

Heated Accessories Wiring Harness <i>(Not illustrated)</i>	Maverick, Maverick MAX	710005757
	Maverick MAX	715006004
<ul style="list-style-type: none"> • Electric harness required to hook up and operate front heated seats, heated steering wheel and heated grab bar. • Heated Accessories Wiring Harness (715006004) is required for rear seat installation. 		

Auxiliary Battery Installation Kit <i>(Not illustrated)</i>	Maverick, Maverick MAX	715006315
<ul style="list-style-type: none"> • Allows you to add a second 18 Ah battery for a dual battery setup necessary to power auxiliary electrical components such as sound systems or winches. • Equipped with an IP67-rated waterproof electronic module that will prevent your auxiliary electrical components from draining your starting battery. • Kit includes an additional battery junction block, all necessary wiring and the battery holder. • Both batteries are perfectly integrated, in stock location, behind the passenger's seat. • Additional battery (410301203), plus battery hardware (250000282) sold separately. 		

ELECTRONIC

Cellphone Holder	Maverick, Maverick MAX	715008786
	<ul style="list-style-type: none"> • Water resistant door allows for perfect phone positioning. • Features capacitive and resistive touch screen technology. • Spring system in back plate automatically adjusts for thickness. • Fits all cellphones within 7.2" (185 mm) x 3.3" (85 mm) x 0.6" (15 mm) dimensions. • Works with almost all charger wires. • Does not include cellphone or charging wires. • Requires the Electronic Device Holder (715002874) for the Cellphone Holder to be bolted on its door. 	

Lighted Whip Flag	Maverick, Maverick MAX	715002886
	<ul style="list-style-type: none"> • A must for riding the dunes. • 5 W Cree LED. • 5 colored lenses to allow personalization. • Glow-through whip, quickly removable and replaceable pole. • Increases vehicle's visibility. • Meets most dune-area requirements. • Die cast aluminum base, acetal hand nut. • Includes mounting brackets and wiring. • 4' (1.2 m) flag mounts on top of the roll cage. • Can be installed on both sides of a vehicle. 	

Digitally Encoded Security System (D.E.S.S.™) Green Key	Maverick (except 900 HO)	710005232
	<ul style="list-style-type: none"> • Top-security anti-theft protection for your vehicle. • Encrypted chip technology restricts access to your vehicle's electronic ignition system. • One vehicle/one code. • A vibration/shock-resistant ball-and-socket design that ensures a reliable connection. • 2 programmable modes: <ul style="list-style-type: none"> - Normal mode: configurable vehicle speed limit between 50 km/h (31 mph) and 136 km/h (85mph) and may have engine torque reduction. - Performance mode: No restrictions. 	

WINCHES & HITCHES

CAN-AM HD WINCHES

Can-Am HD 4500 Winch	Maverick, Maverick MAX	715006416
-----------------------------	------------------------	------------------



- Ergonomic clutch handle.
- Rugged all-steel gears and bushings for more torque and durability.
- Automatic 100% load-holding brake.
- Sealed solenoid for all-weather protection.
- Weather sealed corded remote and dash mounted switch.
- Pulling strength capability of 4,500 lb (2,041 kg).
- 43' of 1/8" (13.1 m of 6.3 mm) wire steel cable.
- Heavy-duty 4-way roller fairlead.
- Winch Electrical Harness (715003585) and winch compatible front bumper are required.
- CE & UKCA Compliant

Can-Am HD 4500-S Winch	Maverick, Maverick MAX	715006417
-------------------------------	------------------------	------------------



- Ergonomic clutch handle.
- Rugged all-steel gears and bushings for more torque and durability.
- Automatic 100% load-holding brake.
- Sealed solenoid for all-weather protection.
- Weather-sealed corded remote and dash mounted switch.
- Pulling strength capability of 4,500 lb (2,041 kg).
- 50' of 1/4" (15.2 m of 6.35 mm) synthetic rope.
- Corrosion-proof aluminum Hawse fairlead.
- Winch Electrical Harness (715003585) and winch compatible front bumper are required.
- CE & UKCA Compliant

WINCH ACCESSORIES

NEW Winch Cable Stopper	All Can-Am HD Winches	715009921
--------------------------------	-----------------------	------------------



- Made of EPDM, a highly durable synthetic rubber.
- The Winch Cable Stopper isn't just for looks. It helps extend the life of the winch, rope, hook, and fairlead.
- In addition, the split design makes it easy to install.

Can-Am HD Hawse Fairlead	Can-Am HD Winch	715006426
---------------------------------	-----------------	------------------



- A must when upgrading your winch with a synthetic cable, this corrosion-proof aluminum Hawse fairlead will prevent the cable from snapping in a corner of a roller fairlead and from wearing prematurely due to the rough surface of the worn roller guide.
- Must be used with synthetic cables only.

WARN Hawse Fairlead	WARN Winch	715007785
----------------------------	------------	------------------



- Double-powder-coated construction.
- To be used with synthetic winch cables only.

Synthetic Winch Cable	Can-Am HD Winch	715006430
	WARN Winch	715007783



- 50' of 1/4" (15.2 m of 6.35 mm) synthetic cable for Can-Am HD winches.
- Can-Am HD Hawse Fairlead (715006426) is required when upgrading to a synthetic cable to avoid premature cable damage and wear.
- WARN Hawse Fairlead (715007785) is required when upgrading to a synthetic cable to avoid damage and premature wear of the cable.

Wire Rope Replacement	Can-Am HD Winch	705014978
	WARN Winch	715006699



- 43' of 1⁵/₁₆" (14,3 m of 6,3 mm) wire rope for Can-Am HD Winch.
- 55' of 1/4" (16,8 m of 6,35 mm) wire rope for WARN winch kit.
- 4,500 lb (2,041 kg) pulling strength.

Synthetic Cable Extension		715001120
----------------------------------	--	------------------



- Lightweight 1/4" (6,35 mm) diameter, easy to handle and won't rattle in cargo box.
- Easily attaches to winch cable to provide additional 50' (15,2 m) of distance.
- 4,500 lb (2,041 kg) single line capacity.

Winch Electrical Harness <i>(Not illustrated)</i>	Maverick, Maverick MAX	715003585
---	------------------------	------------------

- Required for winch installation.

Rear Winch Harness <i>(Not illustrated)</i>		715006007
---	--	------------------

- Required for installation of a winch on the S3 Rear Winch Bumper.

NEW Wireless Winch Remote	With Can-Am HD Winch	715008286
----------------------------------	----------------------	------------------



- On/Off and Winch In / Winch Out buttons with LED indicator light.
- Large Winch In / Winch Out buttons for easy activation with gloves.
- Ergonomic remote handle shape with a trigger-like holding protrusion.
- Quick and easy to install, thanks to a wiring harness with an integrated antenna and all necessary mounting hardware.
- Allows you to operate your winch from anywhere within a 50' (15,2 m) radius, increasing your recovery options.
- All components are IP67 sealing rated.
- The remote also floats in case it's dropped during a deep water recovery.
- Dash and handlebar mounting options.
- Compatible with all Can-Am HD winches.

Wired Remote Control	Can-Am HD Winch [†]	715006504
-----------------------------	------------------------------	------------------



- This kit allows winch owners to add the hand-held remote to vehicles with a stock winch.
- OEM stock winch is sold separately.
- EC compliant.

[†] Harness (710001023) is required to use remote control on a vehicle with a factory installed winch.
[‡] Remote control (710007050) and connection socket are included.

X rc/X mr Rear Tow Hook	Maverick, Maverick MAX 2021 & prior	715004450
--------------------------------	-------------------------------------	------------------



- Offers a solid place to hook onto in case towing is needed.
- Allows you to attach most straps and hooks.
- Made of rugged 3/16" (5 mm) steel plate and 5/8" (16 mm) steel hook tube.
- Standard on Maverick X rc and X mr models.

HITCHES

Rear Hitch	Maverick, Maverick MAX 2021 & prior	■ 715002883 - Black
		■ 715003938 - Can-Am Red



- Rugged lightweight steel construction.
- E-coated finish.
- Fixed mounting point for trailer ball to provide vehicle with towing capabilities.
- This hitch offers 1,300 lb (590 kg) of towing capacity.
- Hitch ball not included.

Front and Rear Hitch Drawbar	Maverick, Maverick MAX	715008350
-------------------------------------	------------------------	------------------



- Standard on 2" (5 cm) receiver hitch.
- It offers 1,650 lb (750 kg) of towing capacity.
- Hitch ball not included.
- Forged steel.

PERFORMANCE

Performance Half Shaft	Maverick, Maverick MAX	705401634 · 64"
	Maverick, Maverick MAX	705402048 · 72"



- High-performance design ideal for off-road use, with superior protection in any riding usage.
- Includes CVs, shaft and boots with the best suited geometry for your Can-Am vehicle.
- Required to install the Smart-Lok™ Differential Kit.

Mud Smart Mode Module <i>(Not illustrated)</i>	Maverick, Maverick MAX with Smart-Lok Differential (except Turbo RR models 2021 & up)	715005282
--	---	------------------

- This module allows you to add the Mud Smart Mode to vehicles with the Smart-Lok Differential Kit sold as an accessory or to change to the Mud Smart Mode on vehicles equipped with a standard Smart-Lok.
- The Mud Mode has been specially designed to deliver superior traction in the deepest mud holes.
- When high engine torque and/or slippage is detected, Smart-Lok will fully lock the front end.
- The system will stay locked until throttle release.
- Only one Smart Mode Module can be installed at a time.

Rock Smart Mode Module <i>(Not illustrated)</i>	Maverick, Maverick MAX with Smart-Lok Differential (except Turbo RR models 2021 & up)	715005283
---	---	------------------

- This module allows you to add the Rock Smart Mode to vehicles with the Smart-Lok Differential Kit sold as an accessory or to change to the Rock Smart Mode on vehicles equipped with a standard Smart-Lok.
- The Rock Mode has been specially designed to help cross challenging rocks.
- When high engine torque is detected at low vehicle speed, Smart-Lok will progressively lock the front end and will stay engaged until throttle release to prevent wheel slippage and provide optimal traction.
- The progressive engagement allows for easier steering when maneuvering the vehicle.
- Only one Smart Mode Module can be installed at a time.

Trail Activ Smart Mode Module <i>(Not illustrated)</i>	Maverick, Maverick MAX with Smart-Lok Differential (except Turbo RR models 2021 & up)	715005284
--	---	------------------

- This module allows you to add the Trail Activ Smart Mode to vehicles with the Smart-Lok Differential Kit sold as an accessory or to change to the Trail Activ Smart Mode on vehicles equipped with a standard Smart-Lok.
- The Trail Activ mode has been designed for aggressive riding, delivering the ultimate cornering precision.
- When high engine torque and/or an increase in vehicle speed is detected, Smart-Lok will progressively engage the front end and maintain it engaged until throttle release or vehicle speed reduction.
- The progressive engagement allows for smoother and lower steering effort.
- Only one Smart Mode Module can be installed at a time.

Lonestar Racing Mud Flaps with Brackets	Maverick, Maverick MAX	715004865
--	------------------------	------------------



- These bolt-on mud flaps make a great addition.
- Durable chromoly brackets.
- Protect trailing arms, rotors and CVs from rocks and debris.
- Sold in pairs.
- Incompatible with HMWPE Front A-Arm and Trailing Arm Protector (715002905 and 715003552).

Lonestar Racing Heavy-Duty Shift Plate & Knob	Maverick, Maverick MAX	715004866
--	------------------------	------------------





- The shift plate is made from durable stainless steel and bolts into place for a secure fit.
- The kit comes with a billet aluminum Lonestar Racing shift knob.
- Offers improved durability for the performance-oriented driver.

Lonestar Racing Outer Toe Link Boxed Gussets Roller Fairlead	Maverick, Maverick MAX 2021 & prior	715004868
---	-------------------------------------	------------------



- Protects and strengthens the middle radius rod links from rough riding conditions.
- Includes high-grade steel bolts.

Lonestar Racing Quick Release Clutch Cover Pins	Maverick, Maverick MAX	715005045
	<ul style="list-style-type: none"> • This kit will allow you to take off your clutch cover in seconds to access the belt tool-lessly. • Includes 4 stainless steel "quick release" pins with clips and tethers. • Replaces all clutch cover screws. • This product affects the clutch cover sealing. It is highly recommended to use this product under dry riding conditions only. 	
Lonestar Racing Heavy-Duty Rear Boxed Radius Rod Support Plate	Maverick, Maverick MAX 2021 & prior	715005046
	<ul style="list-style-type: none"> • Double-layered radius rod support plate made of high-grade steel. • Reinforces your rod mounting location on the frame while adding a mean racing look to your vehicle. • Easy to install. 	
Yoshimura† Slip-on Exhaust	Maverick, Maverick MAX	715002882
	<ul style="list-style-type: none"> • Developed in collaboration with Yoshimura. • Made from 304-grade stainless steel with brushed aluminum tip. • Better sounding, better looking and 19% lighter than stock muffler. • USDF/USDA approved spark arrester. • Fuel injection system tuning not required. • ROHVA and EPA compliant. • Not CE Compliant. 	
Performance Air Filter by Twin AIR†	Maverick, Maverick MAX	715002895
	<ul style="list-style-type: none"> • The best choice for the harshest conditions. • Multiple staged oiled filtering foam for superior dust retaining capacity with high airflow. • Washable and reusable. 	
Snorkel Pre-Filter	Maverick, Maverick MAX (with Snorkel Kit)	715005599
	<ul style="list-style-type: none"> • Pre-filter specifically for snorkels. • Adds extra protection to your engine in harsh riding conditions. • Helps keep air filter cleaner. • Filter blocks particles larger than 0.005" (0.13 mm). • Necessary to maintain vehicle warranty when tracks are installed. 	
Snorkel Kit	Maverick, Maverick MAX (2019 and prior)	715003733
	Maverick, Maverick MAX (2020 & up)	715007110
<ul style="list-style-type: none"> • Raises point of engine and CVT air intakes so vehicle can be semi-submersed in water or mud without the engine taking in water. • Not compatible with S&B Particle Separator, LinQ Pivoting Rack, Lonestar Racing Rear Intrusion Bar or any rear panels or windows. • Sealed Air Box 707800780 (sold separately) is required for installation on models manufactured before January 1, 2018. • Standard on Maverick X mr models. • Not EC-compliant. • No fit on all models equipped with remote shock reservoir mounted on C-pillar. 		
Radiator Relocator	Maverick, Maverick MAX	715004937
	<ul style="list-style-type: none"> • Relocates stock radiator to rear of cage. • Protects it from debris and rocks. • Prevents cooling performance loss in muddy conditions. • Reduces hot air in the cabin. • Easy to clean. • Includes support hardware and hoses. • Not compatible with any bed accessories, Rear Cage mounted accessories, Complete MTX Audio system and Upper Soft Doors (except LinQ 8 gal [30 L] Cooler Box). • Radiator (709200703) is required for installation on 2017 models. • Not compatible with full windshield. 	
850 W Magneto Kit	Maverick, Maverick MAX (2021 & up)	715006279
	<ul style="list-style-type: none"> • Increases the magneto output to 850 W. • Includes rotor, stator and regulator. 	

WARNING: Any modifications or addition of accessories may affect the handling of your vehicle. It is important to take the time to get familiar with the vehicle once modifications are made to understand how to adapt your driving behavior accordingly. Do not tamper with unauthorized modifications or install equipment not specifically certified by BRP for the vehicle. These modifications have not been tested by BRP and they may increase the risk of injury or loss of control, or render the vehicle illegal to ride. Ask your authorized BRP dealer for suitable available accessories for your vehicle.

EMERGENCY ACCESSORIES

Lonestar Racing Fire Extinguisher Support

Maverick, Maverick MAX

715007320



- Quick-release support that lets riders slide the fire extinguisher out in a matter of seconds in an emergency.
- Made of billet anodized black aluminum.
- Fits 1.85" (4.7 cm) tubing.
- Can be fixed anywhere on the cage.
- Provides riders with the safety and security of knowing they have dependable emergency equipment on board.
- Comes with both billet mounts, quick-pull pin, mounting plate and two clamps.
- Fire extinguisher sold separately.
- "Lonestar Racing for Can-Am" branded.

Fire Extinguisher

295100833



- Ideal for grease, oil and electrical fires.
- Fits with Lonestar Racing Fire Extinguisher Support Kit.
- Not EC compliant.

Emergency Kit

Maverick, Maverick MAX

715006102



- Complete emergency kit provides all essential equipment and supplies to get out of most unfavorable situations powersport enthusiasts can find themselves in.
- Includes: jumper cables, air compressor, tire repair kit, ratchet tie-down, duct tape, 3,300 lb (1,500 kg) tow strap, zip-ties, cloth rags.

WARNING: Any modifications or addition of accessories may affect the handling of your vehicle. It is important to take the time to get familiar with the vehicle once modifications are made to understand how to adapt your driving behavior accordingly. Do not tamper with unauthorized modifications or install equipment not specifically certified by BRP for the vehicle. These modifications have not been tested by BRP and they may increase the risk of injury or loss of control, or render the vehicle illegal to ride. Ask your authorized BRP dealer for suitable available accessories for your vehicle.

No traction? No problem. Apache XC Tracks are built for serious terrain. With improved flotation and stability, they tackle deep snow, mud, and everything in between. Engineered for optimized attack angles, reduced noise, and unmatched durability, this system means all-season dominance.

DESIGNED FOR PEAK PERFORMANCE

Aggressive lugs deliver max traction without sacrificing handling. A reinforced steel frame boosts strength, while the center slide improves alignment and reduces de-tracking. Reduced NVH levels and the wheel placement ensure smooth, quiet power delivery. Plus, wheel longevity is increased with replaceable wheel bearings.



APACHE TRACK SYSTEMS

YEAR-ROUND TRACKS LIMITED WARRANTY*

Apache XC LT Track System	Maverick, Maverick MAX	715007719
 <ul style="list-style-type: none"> • Long Track version. • Brand-new track design to optimize driving off-road and in deep snow conditions . • Reduction in steering effort thanks to the tandem 4 wheels. • Vibrations are reduced due to the alignment of the wheels with the rolling band of the track and the shaft damper mounted tandem. • Better steering precision because of this wheel and track alignment due to good ground contact. • 1.25" (3.175 cm) lugs in the front and in the back for better traction and lateral stability. • Track width: front 12.5" and rear 15". • Adds 3" (7.62 cm) of ground clearance versus 27" tires. 		<ul style="list-style-type: none"> • Additional shaft dampers, tandem dampers, track design and wheel layout significantly reduce NVH (noise vibration harshness). • Central guide for optimized track alignment and reduced occurrences of detracking. • Optimized track layout with increased angle of attack for better obstacle crossing and snow performance. • Stamped and welded steel frame for improved strength and durability. • Easy maintenance with replaceable hub and wheel bearings. • Main hub is oil bath with 3 bearings inside for consistent lubrication. • DPS module and engine and CVT pre-filter required. • Mounting kit sold separately.

NEW Apache XC LT Mounting Kit	Maverick, Maverick MAX (64" models)	715008873
 <ul style="list-style-type: none"> • Required for the installation of the Apache XC LT Track System. • DPS module and Engine Pre-Filter not included. 	Maverick, Maverick MAX (72" models)	715008614

*The limited warranty is subject to the exclusions, limitations of liabilities and all other terms and conditions of BRP's standard limited warranty.

Apache Backcountry LT Track System	Maverick, Maverick MAX	715004734
	<ul style="list-style-type: none"> Tracks designed to deliver the best snow performance on the market with unmatched flotation level and traction on snow surface. Large contact patch, 37% bigger than the Apache 360 LT. Impressive added ground clearance of 7" (18 cm) helps keep the vehicle over the snow. Lightweight snowmobile-inspired rail design. Aggressive track design with 2" (5 cm) lug height for maximum traction on snow. Apache Backcountry LT Mounting Kit, Track DPS Module and Engine and CVT Pre-Filter are required. Fine-tune your track system using extra Idler Wheels, Sliders with Vespel Inserts and Rail Ice Scratcher. For winter use only. Track installation will affect vehicle width and length. 	

*The limited warranty is subject to the exclusions, limitations of liabilities and all other terms and conditions of BRP's standard limited warranty.

Apache Backcountry LT Mounting Kit <small>(Not illustrated)</small>	Maverick, Maverick MAX	715004397 · 64" models 715004394 · 72" models
<ul style="list-style-type: none"> Required for installation of the Apache Backcountry Track LT System. DPS™ Module and Pre-Filter are required and sold separately. 		

APACHE ACCESSORIES

Rail Ice Scratchers	Apache Backcountry LT Track System	860201728
	<ul style="list-style-type: none"> Provide additional lubrication in hard and icy conditions. Rail mounted, small, light. Design expands on coil concept to allow reversing without damage. Easily stored when not in use. Extends slider life. 	

Apache Backcountry LT Wheel Kit	Apache Backcountry LT Track System	715006293
	<ul style="list-style-type: none"> Additional wheel kit for Backcountry LT rear tracks. Reduces drag and rolling resistance in hard snow conditions or when transporting heavier loads. Extends slider life in hard snow conditions. Includes two wheels, cross shaft and mounting hardware per kit to service one track corner. Up to two kits per rear track can be installed. 	

Sliders with Vespel[®] Inserts	Apache Backcountry LT Track Systems	503194815
	<ul style="list-style-type: none"> Use DuPont Vespel inserts for less friction. Longer life. Can be cut to desired length. 8 needed per vehicle. Sold individually. 	

Track DPS Module <small>(Not illustrated)</small>	Maverick, Maverick MAX (Turbo RR Engine only)	715006266
	Maverick, Maverick MAX (2022 & prior except Turbo RR Engine)	715007338
<ul style="list-style-type: none"> Innovative DPS module that ensures speedometer accuracy and optimized steering assist, making for perfect track control and riding ease. Required to install the Apache Track Systems. See table for fit, compatibility and requirements. 		

Engine & CVT Air Intake Pre-Filter	Maverick, Maverick MAX (except X mr models)	715005600
	<ul style="list-style-type: none"> Adds extra protection to your engine in harsh riding conditions. Helps keep air filter cleaner. Filter blocks particles larger than 0.007" (0.19 mm). Easy installation. Not compatible with S&B Particle Separator. Necessary to maintain vehicle warranty when tracks are installed. 	
<p><i>Required to install the Apache Backcountry LT and Apache 360 LT Track Systems.</i></p>		

*The limited warranty is subject to the exclusions, limitations of liabilities and all other terms and conditions of BRP's standard limited warranty.

APACHE TRACK SYSTEMS FITTING GUIDE

APACHE BACKCOUNTRY LT

Model Year / Model	Track	Track Mount	Track DPS Module	Pre-filter without Snorkel	Pre-filter with Snorkel
2017 & Up Maverick, Maverick MAX (64" Models)	715004734	715004397	715007338 Maverick, Maverick Max 2022 & prior (except Turbo RR Engine) OR	715005600 (except X mr)	715005599
2017 & Up Maverick, Maverick MAX (72" Models)		715004394	715006266 Maverick, Maverick Max 2023 and up, and 2022 & prior with Turbo RR engines		

APACHE XC LT

Model Year / Model	Track	Track Mount	Track DPS Module	Pre-filter without Snorkel	Pre-filter with Snorkel
2017 & Up Maverick, Maverick MAX (64" Models)	715007719	715008873	715007338 Maverick, Maverick Max 2022 & prior (except Turbo RR Engine) OR	715005600 (except X mr)	715005599
2017 & Up Maverick, Maverick MAX (72" Models)		715008614	715006266 All Maverick, Maverick Max 2023 and up, and 2022 & prior with Turbo RR engines		

*The limited warranty is subject to the exclusions, limitations of liabilities and all other terms and conditions of BRP's standard limited warranty.



BUILD A KIT THAT WORKS HARD.

Combine a mounting kit, push frame, and blade. Then, customize with accessories like the plow angling kit, blade extensions, or edge markers. Easy to install, engineered to last, and tough enough for brutal winter jobs—this lineup covers every plowing need.



PROMOUNT PLOWS

ProMount PLOW KITS – REFERENCE CHARTS

	72" Black Steel	72" Flex2
Plow Kit	715008176	715008175
Blade	715009877	715009868
Push Frame	715008116	715008116
Mounting Plate	715008197	715008197

CAN-AM ProMount STEEL PLOW KITS

Can-Am ProMount Steel 72" (183 cm) Plow Kit	Maverick, Maverick MAX	■ 715008176 • Black
--	------------------------	---------------------



- These kits include:
 - Can-Am ProMount Steel Blade
 - Push Frame with Quick-Attach System
 - Can-Am ProMount Mounting Plate

CAN-AM ProMount STEEL BLADES

Can-Am ProMount Steel 72" (183 cm) Blade

Fits ProMount Push Frame

■ 715009877 - Black



- Plow blade made from 12-gauge steel.
- Replaceable wear blade.
- Large pin designed for easy blade rotation to eliminate snow buildup at pivot point.
- Blade design provides best snow roll-off at any angle.
- Clears 66" (168 cm) when plow is fully angled.
- Blade height of 17" (43 cm).
- Compatible with Can-Am ProMount Blade accessories to further enhance plow versatility.
- Not compatible with S3 High Clearance Front A-Arm.

CAN-AM ProMount ANGLE PLOWS

Can-Am ProMount 72" (183 cm) Steel Oneway State Blade

Fits ProMount Push Frame

715009879



- Make the job easier with the right tools, clear long alleys and make the task easier by sending the snow further out of the way.
- Wing end of plow measures 26" (67 cm) high and tapers down to 16" (41 cm).
- One-way "winged" state plow designed to throw snow higher.
- Rubber Flap (715007299) designed to keep snow away from the driver is offered as accessory (sold separately).
- Can-Am branded.

CAN-AM ProMount FLEX2 PLOW KIT

Can-Am ProMount Flex2 72" (183 cm) Blade

Maverick, Maverick MAX

715008175



- These kits include:
 - Can-Am ProMount Flex2 Blade
 - Push Frame with Quick-Attach System
 - Can-Am ProMount Mounting Plate

CAN-AM ProMount FLEX2 BLADES

Can-Am ProMount Flex2 72" (183 cm) Blade

Fits ProMount Push Frame

715009868



- Plow blade made of UHMWPE, flexible and impact absorbing material prevents damaging your plow when accidental impact occurs.
- Replaceable wear blade.
- Large pin designed for easy blade rotation to eliminate snow buildup at pivot point.
- Blade design provides best snow roll-off at any angle.
- Clears 66" (168 cm) when plow is fully angled.
- Blade height of 17" (43 cm).
- Compatible with Can-Am ProMount Blade accessories to further enhance plow versatility.

CAN-AM ProMount PLOW ACCESSORIES

Can-Am ProMount Edge Markers

Fits ProMount Plow Blades

715004206

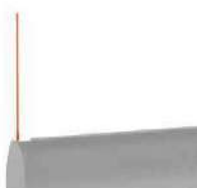

- Help locate the edges of your plow.
- Height: 24" (60 cm).
- Sold in pairs.
- Compatible with Can-Am ProMount Steel and Flex2 Blades with or without Blade Extensions (except for the Can-Am ProMount Steel 54" (137 cm) Blades).

Can-Am ProMount 72" (183 cm) Plastic Wear Blade

Fits ProMount Plow Blades

715004483



- Ideal to prevent marks on your driveway.
- Compatible with Can-Am ProMount 72" (183 cm) Blades.

Can-Am ProMount Drift Cutters	Fits ProMount Plow Blades	715006258
--------------------------------------	---------------------------	------------------



- Help keep snow in the plow.
- Dimensions: 17" x 13" (43.2 cm x 33 cm).
- Sold in pairs.
- Compatible with Can-Am ProMount Steel and Flex2 blades with or without Blade Extensions (except for the Can-Am ProMount Steel 54" (137 cm) Blades).

Can-Am ProMount Blade Extensions	Fits ProMount Plow Blades	<ul style="list-style-type: none"> ■ 715004205 - Black ■ 715005319 - Yellow
---	---------------------------	---



- These conveniently extend your Can-Am ProMount Blade.
- Add 3" (8 cm) each side.
- Compatible with Can-Am ProMount Blades (except for the Can-Am ProMount Steel 54" (137 cm) Blades).
- Longer wear blade can be installed to go over the extra length given by the extensions.

Back Drag Blade <i>(Not illustrated)</i>	Fits ProMount Plows (60" and more)	715007794
--	------------------------------------	------------------

- ¼ thick steel swivel scraper.
- Lifts up when the vehicle is moving forward so as not to affect the scraping.
- Increased capacity to pull snow.
- More aggressive scraping in reverse mode.
- Lifts the scraper off the ground so that it scrapes evenly.
- Adjustable in length for compatibility with 60", 66" and 72" blades.
- Compatible with ProMount blades (Flex and Steel).
- Not compatible with Backcountry Track Kit.

Curved Wear Blade <i>(Not illustrated)</i>	Maverick, Maverick MAX	715007793 · 72" (183 cm)
--	------------------------	---------------------------------

- Wear blade designed with a folded back bottom lip.
- The increased surface allows for less digging while plowing uneven surfaces.
- Ideal for snow covered gravel, grass, paver stone and other soft surfaces.

CAN-AM ProMount CUSTOM SOLUTIONS

Can-Am ProMount Push Frame with Quick-Attach System	Maverick, Maverick MAX	715008116
--	------------------------	------------------



- Heavy-duty steel tubes designed to withstand the roughest use.
- Mid-mount carriage provides ultimate push strength and traction.
- Designed for maximum plow lift height.
- Features a self aligning quick-attach system, an easy foot release pedal and an ergonomic handle for plow angle adjustment.
- Plow Limit Switch recommended to extend winch cable lifespan.
- Can-Am ProMount Mounting Plate required for installation.
- Blade swivels left or right, 5 positions.
- Large pin designed for easy blade rotation to eliminate dirt and snow buildup at pivot point.
- Plow Roller Fairlead included.

Can-Am ProMount Push Frame Extension	Maverick, Maverick MAX	715006257
---	------------------------	------------------



- 12" (30 cm) push frame extension required when plow is installed with Apache Track systems.

Can-Am ProMount Mounting Plate	Maverick, Maverick MAX	715008197
---------------------------------------	------------------------	------------------





- Required to install the Can-Am ProMount Push Frame with Quick-Attach System.
- Mounting plate precision designed to stay on year round without compromising ground clearance.
- Comes with the Plow Roller Fairlead.
- Not compatible with S3 High Clearance Front A-Arm.

Can-Am ProMount Plow Angling System	Maverick, Maverick MAX	715009241
--	------------------------	------------------



- Converts your plow system into an easy-to-control unit from the driver's seat.
- Allows you to have full up/down and left/right plow control at your fingertips with the supplied joystick.
- Using one hand to control all plow motions allows you to easily concentrate and manage your plowing tasks.
- Compatible with the SxS ProMount Push Frame and Blade.
- Not compatible with Apache Backcountry LT Track System.
- Push Frame Extension (715006257) is required for installation with the Front Rancher Bumper.
- Winch and plow sold separately.

NEW Plow Quick Adjust Blade Shoes	ProMount steel & Flex2 Blades 60" (all years), 66" & 72" (2025 & prior)	715009751
	<ul style="list-style-type: none"> • Zinc-plated steel construction for corrosion resistance. • Easy and quick tool-free adjustment. • Pre-set adjustment for different heights. • Larger shoe diameter for greater ground contact. • Improved shoe design for better flotation. 	

ProMount Plow Limit Switch	Maverick, Maverick MAX	715006259
	<ul style="list-style-type: none"> • For controlling the cable tension when over-raising your plow system. • Prevents winch, plow push frame and vehicle damage. • Sensor relocated for optimal lift height. 	

Plow Roller Fairlead	Maverick, Maverick MAX	715001223 • Cylindrical Roller Fairlead
	<ul style="list-style-type: none"> • Larger diameter lower roller reduces wear on wire rope for plow application. • Can be used with all ProMount plows. 	

COVER & TRAILERING

Trailer Cover <i>(Not illustrated)</i>	Maverick Maverick MAX	715005813 715005814
	<ul style="list-style-type: none"> • Heavy-duty canvas made of UV-resistant solution-dyed polyester. • Inner soft liner protects windshield and colored panels from abrasion. • All high-abrasion areas are reinforced with a double canvas layer. • Weather-resistant trailering cover protects your vehicle during storage and transportation. • Opening for fuel cap and cabin access on passenger side. • Quick and easy installation. • Designed to perfectly fit your vehicle with or without Can-Am accessories. 	

Bolt-On[†] Retractable Ratcheting Tie-Downs		295101072
	<ul style="list-style-type: none"> • Perfect for transporting your powersport vehicle or securing loads. • Mount easily: bolt on any flat surface (e.g., truck bed or frame). • 1" x 6' (2.5 cm x 1.8 m) tie-down strap with heavy-duty stitching that delivers a 500 lb (226 kg) working load strength and 1,500 lb (680 kg) break strength. • Convenient retractable push button automatically slackens, spools and stores away strap, while the ratchet mechanism tightens the strap snugly to secure your vehicle or load into place. • Rubber ratcheting handle provides firm grip, and the hook is vinyl coated to protect whatever surface it hooks into. • Sold in pairs. 	

Ratchet Tie-Downs		■ 715008309 • Black/Gray
	<ul style="list-style-type: none"> • 400 lb (181 kg) safe working load. • 1" x 10' (2.5 cm x 3 m) strap with Sea-Doo, Ski-Doo and Can-Am logos. • Deluxe ratchet with rubber handle. • Coated S hooks. • Pack of 2. 	

Heavy-Duty Ratchet Tie-Down		715008308
	<ul style="list-style-type: none"> • 1,000 lb (454 kg) safe working load. • 1.5 in. x 6 in. (38 mm x 1.8 mm) strap with BRP brands. • Deluxe ratchet with rubber handle. • Black-coated clip hooks. • 12" (300 mm) webbing included. • Pack of two. 	

CAN-AM MAVERICK TRAIL & MAVERICK SPORT





MAVERICK TRAIL & MAVERICK SPORT ACCESSORIES

MAVERICK TRAIL & MAVERICK SPORT COMPARATIVE CHARTS

154

ACCESSORIES

156

Roofs	157
Soft Cab Enclosure	157
Windshields & Wind Protection	158
Mirrors	160
Doors	161
Seat Accessories	162
Maverick Trail & Maverick Sport Skid Plates	163
Bumpers & Guards	164
LinQ: Easy On, Easy Off Cargo	166
Cargo & Storage	172
Racks & Holders	173
Lights	175
Audio & Communication Systems	180
Electrical & Electronic Accessories	181
Winches & Hitches	183
Performance	184
Apache Track Systems	186
ProMount Plows	189
Covers	192

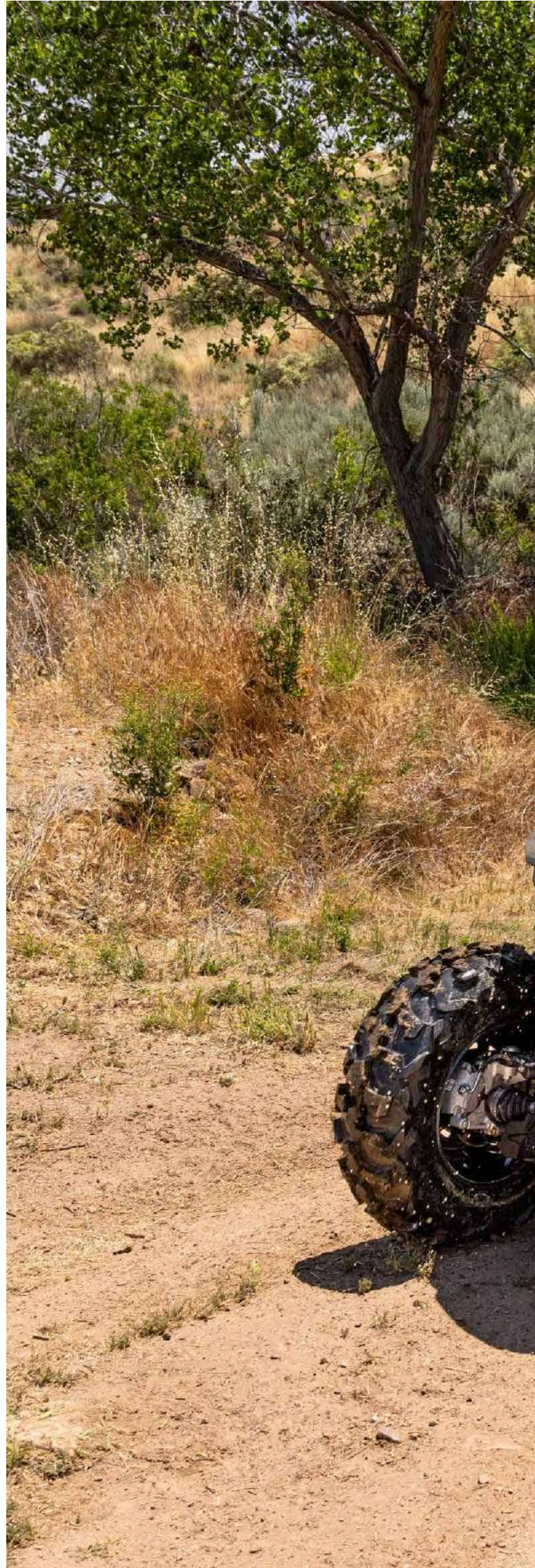





MAVERICK TRAIL 700 T

MAVERICK TRAIL DPS 700 T ABS

MAVERICK TRAIL DPS 1000 T ABS

COLOR OPTIONS		CATALYST GREY	TRIPLE BLACK	TRIPLE BLACK
ENGINES	Type	52 hp / 42 lb-ft, Rotax® ACE (Advanced Combustion Efficiency) 650 cc single cylinder, liquid cooled, catalytic converter	52 hp / 42 lb-ft, Rotax® ACE (Advanced Combustion Efficiency) 650 cc single cylinder, liquid cooled, catalytic converter	75 hp, Rotax® 976 cc, V-twin, liquid cooled, catalytic converter
	Fuel Delivery System	Intelligent Throttle Control (iTC™) with Electronic Fuel Injection (EFI)	Intelligent Throttle Control (iTC™) with Electronic Fuel Injection (EFI)	Intelligent Throttle Control (iTC™) with Electronic Fuel Injection (EFI)
	Transmission	pDrive primary CVT with engine braking and Electronic Drive Belt Protection L / H / N / R / P	pDrive primary CVT with engine braking and Electronic Drive Belt Protection L / H / N / R / P	Quick Response System (QRS) CVT with high airflow ventilation and Electronic Drive Belt Protection Extra-L / H / N / R / P
	Drive Train	Selectable 2WD / 4WD with Visco-Lok† auto-locking front differential	Selectable Turf Mode / 2WD / 4WD with open front differential with ABS system	Selectable Turf Mode / 2WD / 4WD with open front differential with ABS system
	Power Steering	Electronic Hill Descent Control SPORT / ECO™ modes	Electronic Hill Descent Control SPORT / ECO™ modes	Electronic Hill Descent Control SPORT / ECO™ modes
	Power Steering		Dynamic Power Steering (DPS)	Dynamic Power Steering (DPS)
SUSPENSIONS	Front Suspension	Double A-arm with sway bar / 10 in. (25.4 cm) suspension travel	Double A-arm with sway bar / 10 in. (25.4 cm) suspension travel	Double A-arm with sway bar / 10 in. (25.4 cm) suspension travel
	Front Shocks	Twin tube gas charged shocks	Twin tube gas charged shocks	Twin tube gas charged shocks
	Rear Suspension	TTA with sway bar / 10.5 in. (26.7 cm) suspension travel	TTA with sway bar / 10.5 in. (26.7 cm) suspension travel	TTA with sway bar / 10.5 in. (26.7 cm) suspension travel
	Rear Shocks	Twin tube gas charged shocks	Twin tube gas charged shocks	Twin tube gas charged shocks
TIRES / WHEELS	Front / Rear Tires	Carlisle ACT 26 x 8/9 x 12 in.	Carlisle ACT 26 x 8/9 x 12 in.	Carlisle ACT 26 x 8/9 x 12 in.
	Wheels	12 in. steel	12 in. cast-aluminum	12 in. cast-aluminum
BRAKES	Front & Rear	Dual 220 mm disc brakes with hydraulic twin-piston calipers	Dual 220 mm disc brakes with hydraulic twin-piston calipers	Dual 220 mm disc brakes with hydraulic twin-piston calipers
DIMENSIONS / CAPACITIES	Cage	Profiled cage ROPS approved	Profiled cage ROPS approved	Profiled cage ROPS approved
	Estimated Dry Weight*	1,256 lb (569.7 kg)	1,271 lb (576.5 kg)	1,364 lb (618.7 kg)
	L x W x H	118 x 62.8 x 69 in. (300.5 x 159.6 x 175.3 cm)	118 x 62.8 x 69 in. (300.5 x 159.6 x 175.3 cm)	118 x 62.8 x 69 in. (300.5 x 159.6 x 175.3 cm)
	Wheelbase	90.6 in. (230.1 cm)	90.6 in. (230.1 cm)	90.6 in. (230.1 cm)
	Ground Clearance	10 in. (25.4 cm)	10 in. (25.4 cm)	10 in. (25.4 cm)
	Cargo Box Capacity	300 lb (136 kg)	300 lb (136 kg)	300 lb (136 kg)
	Towing Capacity	1,500 lb (680 kg)	1,500 lb (680 kg)	1,500 lb (680 kg)
	Storage Capacity	Total: 5.3 gal (20.2 L)	Total: 5.3 gal (20.2 L)	Total: 5.3 gal (20.2 L)
	Fuel Capacity	10 gal (38 L)	10 gal (38 L)	10 gal (38 L)
	Person Capacity	2	2	2
FEATURES	Gauge	7.6 in. wide digital display with keypad	7.6 in. wide digital display with keypad	7.6 in. wide digital display with keypad
	Magneto	650-W	650-W	650-W
	Instrumentation	DC outlet (10-A)	DC outlet (10-A)	DC outlet (10-A)
	Anti-theft System	RF Digitally Encoded Security System (D.E.S.S.™) with Start/Stop button	RF Digitally Encoded Security System (D.E.S.S.™) with Start/Stop button	RF Digitally Encoded Security System (D.E.S.S.™) with Start/Stop button
	Lighting	Front lighting output 110-W LED headlights and premium tail lights	Front lighting output 110-W LED headlights and premium tail lights	Front lighting output 110-W LED headlights and premium tail lights
	Winch			
	Steering Wheel	Tilt steering adjustment	Tilt steering adjustment	Tilt steering adjustment
	Protection	Integrated front steel bumper Full skid plate Mudguards	Integrated front steel bumper T-Net (driver), Regular Net (passager front) Full skid plate Mudguards	Integrated front steel bumper T-Net (driver), Regular Net (passager front) Full skid plate Mudguards
	Hitch Type	2 in. hitch receiver with rear hitch, tow ball and trailer connexion	2 in. hitch receiver with rear hitch, tow ball and trailer connexion	2 in. hitch receiver with rear hitch, tow ball and trailer connexion

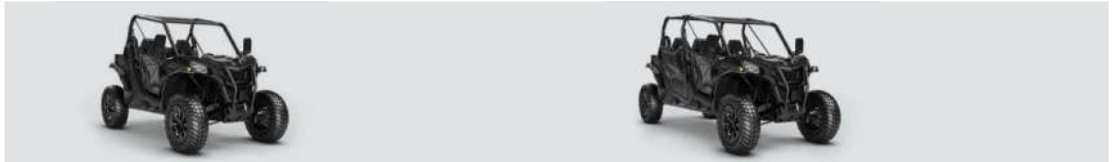

MAVERICK SPORT DPS 1000R T ABS

MAVERICK SPORT MAX DPS 1000R T ABS

COLOR OPTIONS		TRIPLE BLACK	TRIPLE BLACK
ENGINES	Type	95 hp, Rotax® 976 cc, V-twin, liquid cooled, catalytic converter	95 hp, Rotax® 976 cc, V-twin, liquid cooled, catalytic converter
	Fuel Delivery System	Intelligent Throttle Control (ITC™) with Electronic Fuel Injection (EFI)	Intelligent Throttle Control (ITC™) with Electronic Fuel Injection (EFI)
	Transmission	Quick Response System (QRS) CVT with high airflow ventilation and Electronic Drive Belt Protection Extra-L / H / N / R / P	Quick Response System (QRS) CVT with high airflow ventilation and Electronic Drive Belt Protection Extra-L / H / N / R / P
	Drive Train	Selectable Turf Mode / 2WD / 4WD with open front differential with ABS system	Selectable Turf Mode / 2WD / 4WD with open front differential with ABS system
	Power Steering	Electronic Hill Descent Control SPORT / ECO™ modes	Electronic Hill Descent Control SPORT / ECO™ modes
	Power Steering	Dynamic Power Steering (DPS)	Dynamic Power Steering (DPS)
SUSPENSIONS	Front Suspension	Double A-arm with sway bar / 11.5 in. (29.2 cm) suspension travel	Double A-arm with sway bar / 11.5 in. (29.2 cm) suspension travel
	Front Shocks	SHOWA 2.0	SHOWA 2.0
	Rear Suspension	TTA with sway bar / 12 in. (30.5 cm) suspension travel	TTA with sway bar / 12 in. (30.5 cm) suspension travel
	Rear Shocks	SHOWA 2.0	SHOWA 2.0
TIRES / WHEELS	Front / Rear Tires	Maxxis Liberty† 28 x 10 x 14 in.	Maxxis Liberty† 28 x 10 x 14 in.
	Wheels	14 in. cast-aluminum	14 in. cast-aluminum
BRAKES	Front & Rear	Dual 220 mm disc brakes with hydraulic twin-piston calipers	Dual 220 mm disc brakes with hydraulic twin-piston calipers
DIMENSIONS / CAPACITIES	Cage	Profiled cage. ROPS approved	Profiled cage. ROPS approved
	Estimated Dry Weight*	1,405 lb (637.3 kg)	1,697 lb (769.7 kg)
	L x W x H	119 x 62.1 x 71.1 in. (302.2 x 157.8 x 180.6 cm)	149 x 62.1 x 81.2 in. (378.4 x 157.8 x 206.2 cm)
	Wheelbase	90.6 in. (230.1 cm)	120.6 in. (306.3 cm)
	Ground Clearance	12 in. (30.5 cm)	12 in. (30.5 cm)
	Cargo Box Capacity	300 lb (136 kg)	300 lb (136 kg)
	Towing Capacity	1,500 lb (680 kg)	1,500 lb (680 kg)
	Storage Capacity	Total: 5.3 gal (20.2 L)	Total: 6.5 gal (24.7 L)
	Fuel Capacity	10 gal (38 L)	10 gal (38 L)
	Person Capacity	2	4
FEATURES	Gauge	7.6 in. wide digital display with keypad	7.6 in. wide digital display with keypad
	Magneto	650-W	650-W
	Instrumentation	DC outlet (10-A)	DC outlet (10-A)
	Anti-theft System	RF Digitally Encoded Security System (D.E.S.S.™) with Start/Stop button	RF Digitally Encoded Security System (D.E.S.S.™) with Start/Stop button
	Lighting	Front lighting output 110-W LED headlights and premium tail lights	Front lighting output 110-W LED headlights and premium tail lights
	Winch		
	Steering Wheel	Tilt steering adjustment	Tilt steering adjustment
	Protection	Integrated front steel bumper T-Net (driver), Regular Net (passenger front) Full skid plate Mudguards	Integrated front steel bumper T-Net (driver), Regular Net (passenger front) and half doors (rear only) Full skid plate Mudguards
	Hitch Type	2 in. hitch receiver with rear hitch, tow ball and trailer connexion	2 in. hitch receiver with rear hitch, tow ball and trailer connexion

MAVERICK TRAIL/SPORT HERO UNITS PACKAGES

ESSENTIALS	PACKAGE	DESCRIPTION	MAVERICK TRAIL/SPORT
	Starter	Glass Windshield	715003653
		Manual Wiper Kit	715009423
		Sport Roof	715006218 / 715007272
		Rear Polycarbonate Window	715010803
		Electronic Device Holder	715005212
		Emergency Kit	715006102
	* To complete the package we recommend the installation of a Can-Am HD Winch if not coming with the unit.		
+			
	Protection	Front Trail Bumper	715003680
		Rear Trail Bumper	715007109
		License Plate Holder	715007006
		Rock Sliders	715003689 / 715004754
* To complete the package we recommend the installation of a Skid Plate Protection Kit.			
+			
	Audio	Complete Wet Sounds Audio System	715003672
		Can-Am Subwoofer	715006359
+			
	Cargo	Shoulder Storage Bag	715005019
		All-Terrain Trunk Cover	715003701
		LinQ Pivoting Rack	715010787
+			
	Winter	Upper Soft Door Panels – Front	715004718
		Upper Soft Door Panels – Rear	715004726
		Defrost, Heat and Ventilation System	715003678
		Heated Grab Bar Cover	715004500
		Seat Heater	715006112
		Front Heated Accessories Wiring Harness	710005757
		Rear Heated Accessories Wiring Harness	715006004
* To complete the package we recommend the installation of an Apache XC LT track system.			

ROOFS

Sport Roof	Maverick Sport MAX	715007272
	Maverick Trail, Maverick Sport	715006218



- Robust injection-molded polypropylene construction.
- Excellent protection from the elements.
- Allows installation of lights on top of the roof.
- Compatible with all windshields.

ProVent Roof Module Kit	Maverick Trail, Maverick Sport	715005279
--------------------------------	--------------------------------	------------------



- Provides fresh air in the cab area.
- Optimal performance with full cab enclosure.
- 4 vents provide infinite adjustment of air flow for driver and passenger.
- Filter and pre-filter to limit dust intrusion.
- Easy cleaning of filter and pre-filter.
- Patent pending water management system to keep water out of cabin while maintaining air flow.
- Outer plug closes air intake completely for winter or heavy weather.
- Requires ProVent Roof Module Adapter Kit for Sport Roof.
- Not compatible with roof mounted LED bars, roof racks, roof liners, Bimini Roof, DragonFire Roof or Lonestar Racing Roof.

ProVent Roof Module Adapter Kit for Sport Roof <i>(Not illustrated)</i>	Maverick Trail, Maverick Sport	715005213
---	--------------------------------	------------------

- Adapter for fitting ProVent Roof Module Kit onto Maverick Sport or Maverick Trail Sport Roof.
- Includes roof adapter and hardware.
- Requires ProVent Roof Module Kit (715005279).

Bimini[†] Roof with Sun Visor	Maverick Trail, Maverick Sport [†]	715003661
	Maverick Sport MAX	715004792



- Heavy-duty canvas made of UV-resistant solution-dyed polyester.
- Soft top comes with a hard visor that allows for storage of rolled-up soft top and mounting auxiliary lights.

†Not compatible with Glass Windshield with wiper.

Lonestar Racing[†] Aluminum Roof	Maverick Trail, Maverick Sport [†]	■ 715005137 - Black
--	---	----------------------------



- Race-true low profile look with integrated front visor for eye-popping performance and protection.
- 0.083" (2.1 mm) thick aluminum roof for durable and lightweight protection from the elements.
- Not compatible with Full Windshields, Rigid Rear Window, Can-Am Intrusion Bars and Overhead Switch Panel.

SOFT CAB ENCLOSURE

Soft Cab Enclosure	Maverick Trail	715003618
---------------------------	----------------	------------------



- Includes:
- Sport Roof
 - Full Windshield – Hardcoated
 - Upper Soft Door Panels
 - Soft Rear Panel
 - Door Seal Kit
- Requires Trail Half doors on 700 or 800 motorization.
 - Not compatible with Sport Half Doors
- Installation of some accessories shown may impact vehicle compliance with some regulations. Consult your local dealer for information.*

Soft Cab Enclosure	Maverick Trail, Maverick Sport (except X mr models)	715004724
---------------------------	--	------------------



- Can be installed on the Maverick Trail equipped with the Sport Half Doors or on Maverick Sport models.
- Includes:
 - Sport Roof
 - Full Windshield – Hardcoated
 - Upper Soft Door Panels
 - Soft Rear Panel

Installation of some accessories shown may impact vehicle compliance with some regulations. Consult your local dealer for information.

Soft Cab Enclosure	Maverick Sport MAX (except X mr models)	715004725
---------------------------	--	------------------



- Includes:
 - Sport Roof
 - Full Windshield – Hardcoated
 - Upper Soft Door Panels
 - Soft Rear Panel

Installation of some accessories shown may impact vehicle compliance with some regulations. Consult your local dealer for information.

WINDSHIELDS & WIND PROTECTION

WINDSHIELDS

Glass Windshield	Maverick Trail, Maverick Sport, Maverick Sport MAX	715003653
-------------------------	---	------------------



- Curved and laminated glass full windshield in metal frame.
- Provides excellent optical clarity.
- Seals firmly against the cage and protects rider and passenger from the elements.
- Must be used with rear wind protection.
- Not compatible with vehicle with ABS.
- Must be used with windshield wiper to maintain clear visibility during severe riding conditions, such as mud riding.

Installation of some accessories shown may impact vehicle compliance with some regulations. Consult your local dealer for information.

Glass Windshield with Wiper	Maverick Trail, Maverick Sport, Maverick Sport MAX	715003652
------------------------------------	---	------------------



- Curved and laminated glass full windshield in metal frame.
- Provides excellent optical clarity.
- Seals firmly against the cage and protects rider and passenger from the elements.
- Single-speed wiper with washer fluid dispenser.
- Requires the Overhead Switch Panel (715003669) for installation.
- Must be used with rear wind protection.
- Not compatible with vehicle with ABS.

Installation of some accessories shown may impact vehicle compliance with some regulations. Consult your local dealer for information.

Half Windshield	Maverick Trail, Maverick Sport, Maverick Sport MAX	<input type="checkbox"/> 715003657 • Clear <input checked="" type="checkbox"/> 715005280 • Tinted
------------------------	---	--



- Formed polycarbonate construction for enhanced rigidity.
- Formulated to be non-yellowing, non-crazing, non-cracking with excellent UV resistance and optical clarity.
- Protects driver and passenger from the elements.
- Features reverse angle lip to deflect air flow.
- Quick and easy tool-less installation or removal.

Installation of some accessories shown may impact vehicle compliance with some regulations. Consult your local dealer for information.

Full Windshield	Maverick Trail, Maverick Sport, Maverick Sport MAX	715003655
------------------------	---	------------------



- High-impact-resistant durable polycarbonate full windshield.
- Formed polycarbonate construction for enhanced rigidity.
- Formulated to be non-yellowing, non-crazing, non-cracking with excellent UV resistance and optical clarity.
- Seals firmly against the cage and protects rider and passenger from the elements.
- Must be used with rear wind protection.
- Quick and easy tool-less installation or removal.

Installation of some accessories shown may impact vehicle compliance with some regulations. Consult your local dealer for information.

Full Windshield – Hardcoated

Maverick Trail, Maverick Sport,
Maverick Sport MAX

715003656



- High-impact-resistant Quantum¹ hardcoated polycarbonate full windshield.
- Formed polycarbonate construction for enhanced rigidity.
- Provides excellent optical clarity and better abrasion resistance.
- Seals firmly against the cage and protects rider and passenger from the elements.
- Must be used with rear wind protection.
- Quick and easy tool-less installation or removal.

Installation of some accessories shown may impact vehicle compliance with some regulations. Consult your local dealer for information.

ProVent Windshield

Maverick Trail, Maverick Sport,
Maverick Sport MAX

715005210



- High-impact-resistant Quantum¹ hardcoated polycarbonate full windshield.
- Controllable vents to manage air flow.
- Channels air into the cabin, defogs windshield, fully closes to eliminate air flow.
- One upper vent and one lower vent with pre-filters.
- Must be used with rear wind protection.
- Provides excellent optical clarity and better abrasion resistance.
- Protects driver and passenger from the elements.
- Quick and easy tool-less installation or removal.
- Not compatible with wiper kits and Wet Sounds Stealth 6 Ultra HD Can-Am Edition Sound Bar.
- Not compatible with the Defrost, Heat and Ventilation System.

Installation of some accessories shown may impact vehicle compliance with some regulations. Consult your local dealer for information.

PowerFlip Windshield

Maverick Trail, Maverick Sport,
Maverick Sport MAX

715003658



- The PowerFlip Windshield is equipped with electric cylinders that allow the rider to adjust the windshield opening at the touch of a button.
- Windshield is made of hardcoated polycarbonate with a rubber seal contour and a tinted top section.
- Allows you to quickly adapt to changing conditions by adjusting the windshield as you go.
- Can be fully opened for optimal visibility and ventilation, fully closed for maximum protection from the elements, and in between, you have an infinite number of openings.
- Must be used with rear wind protection.

Installation of some accessories shown may impact vehicle compliance with some regulations. Consult your local dealer for information.

Windshield Wiper and Washer Kit

Maverick Trail, Maverick Sport,
Maverick Sport MAX

715003654



- An ideal way to keep your windshield clear in rain, or while riding through mud and water.
- Includes single-speed wiper, washer fluid dispenser and windshield frame mount.
- Must be used with the Glass Windshield (715003653).
- Requires Overhead Switch Panel (715003669) for installation.
- Not compatible with ABS equipped vehicles.

Installation of some accessories shown may impact vehicle compliance with some regulations. Consult your local dealer for information.

Manual Wiper Kit

Maverick Trail, Maverick Sport, Maverick
Sport MAX

715009423



- Single manual wiper that can be used to clear windshield of debris.
- Easy to install system that requires no electrical hookup.
- Large ergonomic handle provides a good grip over the entire sweeping surface.
- Compatible with glass and hardcoated windshields that use top mounted wipers.

Installation of some accessories shown may impact vehicle compliance with some regulations. Consult your local dealer for information.

WIND PROTECTION

Side Wind Deflectors

Maverick Trail, Maverick Sport,
Maverick Sport MAX

715008632



- Clear polycarbonate air deflectors mount on each side of the cage.
- Can be adjusted at three different positions for cabin air flow control when full windshield is installed:
 - 1) Outside deflection to reduce cabin air flow and turbulence.
 - 2) Inside deflection to increase air flow in the cabin.
 - 3) Windshield ventilation to reduce fog.
- Compatible with all windshields.
- Not compatible with full doors.
- Sold in pairs.

Rear Polycarbonate Window	Maverick Trail, Maverick Sport, Maverick Sport MAX (except X mr models)	715010803
----------------------------------	--	------------------



- High-impact-resistant polycarbonate window.
- Blocks windshield backdraft or dust and rain from entering for added cabin comfort.
- Sport Roof is required for installation.
- Not compatible with Bimini Roof with Sun Visor, DragonFire Aluminum Roof and Lonestar Racing Aluminum Roof.

Rear Wind Screen	Maverick Trail, Maverick Sport, Maverick Sport MAX (except X mr models)	715003664
-------------------------	--	------------------



- Full rear mesh screen reduces windshield backdraft for added cabin comfort.
- Installs quickly and easily on roll cage.
- Large Can-Am branding.

Soft Rear Panel	Maverick Trail, Maverick Sport, Maverick Sport MAX (except X mr models)	715005887
------------------------	--	------------------



- Plastic reinforced and weather-resistant rear panel offers good protection from the elements.
- Made of heavy-duty UV-resistant solution-dyed polyester canvas for excellent resistance to tear and abrasion.
- Clear window made of laminated polished vinyl material.
- Resists cold cracking.
- Installs quickly and easily on roll cage.

MIRRORS

Side Mirrors	Maverick Trail, Maverick Sport, Maverick Sport MAX	715003639
---------------------	---	------------------



- Rugged black nylon ½ construction with coated cast-aluminum mount.
 - Dual adjustment (horizontal and vertical) will suit any rider.
 - Convex optics deliver optimal field of view (FOV).
 - Spring-loaded pivots let mirrors fold back completely.
 - Sold in pairs.
- Installation of some accessories shown may impact vehicle compliance with some regulations. Consult your local dealer for information.*

Panoramic Center Mirror	Maverick Trail, Maverick Sport, Maverick Sport MAX	715003638
--------------------------------	---	------------------



- Wide-angle convex mirror.
- Offers enhanced visibility.
- Can be used with or without roof or windshield and with cab enclosure.

Sport Panoramic Center Mirror	Maverick Trail, Maverick Sport, Maverick Sport MAX	715004924
--------------------------------------	---	------------------



- Convex mirror for wide rearward visibility.
- Ball-joint design with tightening knob for steady multi-angle adjustment.
- Can be used with or without roof or windshield.
- Not for road use.

Rear View Mirror and Camera Monitor	Maverick Trail, Maverick Sport, Maverick Sport MAX	715009410
--	---	------------------



- Fully waterproof rearview mirror and monitor kit.
- See exactly what you need to see with the multiple camera feeds from the rear view camera.
- This unit replaces the stock rearview mirror (the screen is integrated in the unit's replacement rearview mirror).
- The camera uses infrared light for night vision capabilities.

DOORS

Trail Half Doors

Maverick Trail

715004418



- Half doors made of molded polypropylene to match vehicle's styling.
- Steel frame for high level of rigidity.
- A must-have for additional cabin comfort.
- Keep the vehicle narrow in tight trail riding conditions.
- Door Trim is required to complete your door kit (sold separately).
- Standard on 1000 Base and 1000 DPS™ models.
- Sold in pairs.

Installation of some accessories shown may impact vehicle compliance with some regulations. Consult your local dealer for information.

Door Trim

Maverick Trail

- Can-Am Red
- Timeless Black
- Octane Blue

Left	705012419
	705015607
	705016447

Right	705012420
	705015613
	705016449



- Matching colored panel for Trail Half Doors.
- Required to complete the Trail Half Doors (sold separately).

Sport Half Doors

Maverick Trail, Maverick Sport, Maverick Sport MAX

715006217



- Half doors made of molded polypropylene to match vehicle's styling.
- A must-have for additional cabin comfort.
- Features rounded shape to increase cabin space.
- Standard on all Maverick Sport models.
- Can be installed on Maverick Trail models for additional cabin space.
- Door Trim is required to complete your door kit (sold separately).
- Sold in pairs.

Installation of some accessories shown may impact vehicle compliance with some regulations. Consult your local dealer for information.

Door Trim

Maverick Trail, Maverick Sport, Maverick Sport MAX

- Can-Am Red
- Timeless Black
- Octane Blue

Left	705015464
	705015608
	705016448

Right	705015465
	705015615
	705016450



- Matching colored panel for the Sport Half Doors.
- Required to complete the Sport Half Doors (sold separately).
- Sold in pairs.

Upper Soft Door Panels

Maverick Trail, Maverick Sport, Maverick Sport MAX
Maverick Sport MAX

715004718 • Front
715004726 • Rear



- Upper canvas portion of the doors with sturdy steel frame.
- Seals firmly against the cage and protects rider and passenger from the elements.
- Converts half door into full door for a complete cab enclosure.
- Zippered window made of laminated polished vinyl material for added ventilation.
- Easy to remove on hot and sunny days.
- Sport Roof required for installation.
- Can be installed on the Maverick Trail equipped with the Sport Half Doors (715006217) or with the standard half doors on Maverick Sport models.

†Not compatible with Trail Half Doors or with the standard half doors on Maverick Trail models.

Installation of some accessories shown may impact vehicle compliance with some regulations. Consult your local dealer for information.

Upper Soft Door Panels

(Not illustrated)

Maverick Trail

715003620

- Can only be installed with Trail Half Doors or with the standard half doors on Maverick Trail models.
- Not compatible with Sport Half Doors or with the standard half doors on Maverick Sport models.
- Sport Roof required for installation.

Installation of some accessories shown may impact vehicle compliance with some regulations. Consult your local dealer for information.

Door Seal Kit
(Not illustrated)

Maverick Trail

715004773

- Improves door sealing from the elements and provides additional cabin comfort.
- Included in the Soft Cab Enclosure Kit (715003618).
- Not compatible with Sport Half Doors.
- Compatible with the Trail Half Doors or with the stock doors on the Maverick Trail.

Door Knee Pads with Storage

Maverick Trail

715003635



- Padded door cushion with integrated pocket for storage.
- Protect driver's and passenger's legs from direct contact with the doors while riding.
- Increase cabin comfort.
- Require Trail Half Door on 800 Base and 800 DPS models (715004418).
- Offer storage space for small items.
- Sold in pairs.
- Not compatible with Sport Half Doors.

Door Storage with Padding

Maverick Trail, Maverick Sport,
Maverick Sport MAX

715004914



- Weather-resistant door storage bags with integrated padding.
- Holds your gear safely and securely and also protects driver's and passenger's legs from direct contact with the doors while riding.
- Each bag is designed as a 0.5 gal (2 L) capacity pocket also equipped with inner netting compartments.
- Semi-rigid construction renders them flexible enough to fit odd-shaped loads.
- Easy to install.
- Sold in pairs.
- Bags attach on stock doors of the Maverick Sport or on the Maverick Trail equipped with the Sport Half Doors (715006217).
- Not compatible with stock doors on the Maverick Trail or the Trail Half Doors.

SEAT ACCESSORIES

4-Point Harness

Maverick Trail, Maverick Sport,

715008035 • Driver

715008036 • Passenger



- Exclusive controlled decelerator technology (patent pending) absorbs additional energy in case of an accident.
- Designed to offer maximum riding comfort.
- Easy one-click latch and release.
- Not EC compliant.
- ROHVA compliant.

Installation of some accessories shown may impact vehicle compliance with some regulations. Consult your local dealer for information.

4-Point Harness Bar

Maverick Sport MAX

715004847



- 1.5" (3.8 cm) diameter, thick-walled steel tubing.
- Designed for use with Can-Am 4-Point Harness.

Installation of some accessories shown may impact vehicle compliance with some regulations. Consult your local dealer for information.

Seat Belt Shoulder Pads

Maverick Trail, Maverick Sport,
Maverick Sport MAX

715002894



- Provide additional riding comfort by preventing seat belt from rubbing on neck and shoulder.
- Fit with stock 3-point seat belts and 4 point harness.
- Easy Velcro installation.
- Can-Am branded.
- Sold in pairs for driver and passenger.

MAVERICK TRAIL & MAVERICK SPORT SKID PLATES

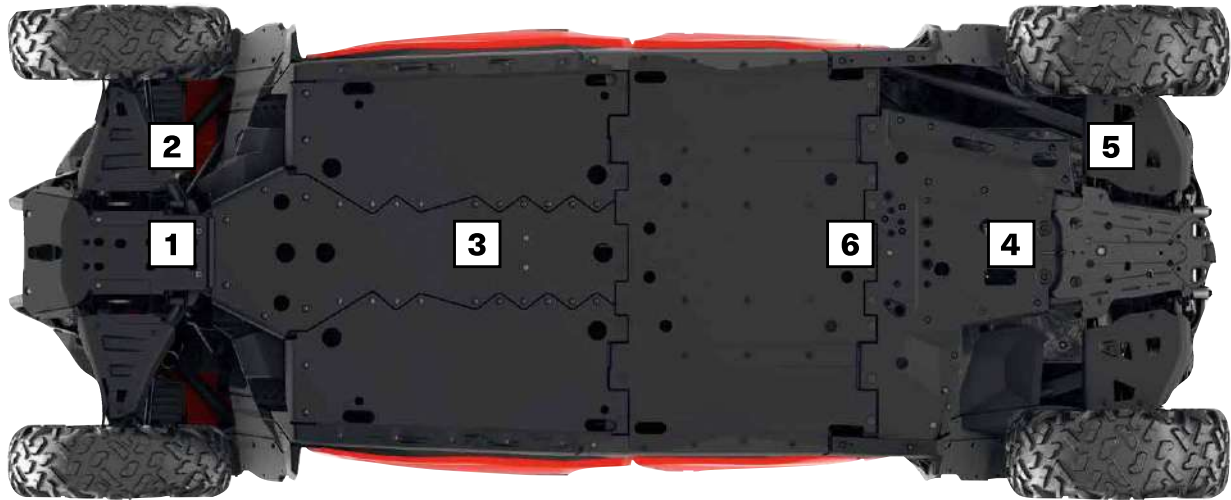

Our plastic plates glide smoothly and silently over obstacles, offering great protection in rough terrain.

- Made of abrasion-resistant thermoformed High Molecular Weight Polyethylene (HMWPE).
- Lighter than aluminum.
- Superior stress crack resistance.
- High impact strength.
- Ultra-sturdy 3/8" (10 mm) thickness.

MAVERICK SPORT & MAVERICK SPORT MAX

MAVERICK TRAIL

Offer your Maverick the full protection kit or get parts individually	2019 Base & DPS	2020 & Up Base & DPS	2020 & Up	
HMWPE SKID PLATE PROTECTION KIT				
Includes:				
- HMWPE Front Skid Plate.	715006348 (except MAX)	715006349 (except MAX)		715006346 (2019 & prior)
- HMWPE Front A-Arm Protectors.				
- HMWPE Rear Skid Plate.			715006350	
- HMWPE Rear A-Arm Protectors.				
- HMWPE Underbelly Plates.	715006352 (MAX only)	715006351 (MAX only)		715006347 (2020 & up)
- HMWPE Central Skid Plate.				
INDIVIDUAL HMWPE SKID PLATES				
1 HMWPE Front Skid Plate	715008279	715008279	715008279	715008279
2 HMWPE Front A-Arm Protectors	715008276	715008276	715008277	715008278
3 HMWPE Underbelly Plates Keep the rollover clearance.	715006339	715006273	715006273	715006339 (2019 & prior) 715006273 (2020 & up)
4 HMWPE Rear Skid Plate	715007302	715007302	715007302	715007302
5 HMWPE Rear A-Arm Protectors	715004271	715004271	715006341	715003699
6 HMWPE Central Skid Plate Provides center protection for MAX models.	715004272 (MAX only)	715004272 (MAX only)	—	—

BUMPERS & GUARDS

MAVERICK TRAIL & MAVERICK SPORT BUMPERS

Front Trail Bumper

Maverick Trail, Maverick Sport,
Maverick Sport MAX

■ **715003680** • Black
■ **715003681** • Sunburst
Yellow



- Front bumper made of heavy-duty 1.5" (3.8 cm) diameter steel tubing.
- Completes the stock bumper for more front coverage and essential vehicle protection for trail riders.
- Inside and outside anti-corrosion coating with durable powder coat finish.
- Includes integrated mount points for seamless light installation.

Rear Trail Bumper

Maverick Trail, Maverick Sport,
Maverick Sport MAX

■ **715007109** • Black



- Rear bumper made of heavy-duty 1.5" (3.8 cm) diameter steel tubing.
- Protects vehicle bodywork and exhaust system.
- Inside and outside anti-corrosion coating with durable powder coat finish.

Front Corner Protectors

Maverick Trail, Maverick Sport,
Maverick Sport MAX

■ **715004912** • Black



- Heavy-duty 1.5" (3.8 cm) diameter steel tubing.
- Inside and outside anti-corrosion coating with durable powder coat finish.
- Provide additional protection for vehicle's front corners.
- Require Front Trail Bumper (715003680 / 715003681) for installation.
- Sold in pairs.

Rancher Rear Bumper

Maverick Trail, Maverick Sport,
Maverick Sport MAX

715004304



- Heavy-duty protection made of 1.5" (3.8 cm) diameter steel tubing, perfect for farm, ranch and forestry applications.
- Inside and outside anti-corrosion coating with durable powder coat finish.

- Offers full rear coverage with integrated tail light protectors.

Installation of some accessories shown may impact vehicle compliance with some regulations. Consult your local dealer for information.

ROCK SLIDERS

Rock Sliders

Maverick Trail, Maverick Sport (except X rc)
(2025 & prior)

■ **715003689** • Black

Maverick Sport MAX (2025 & prior)

■ **715004754** • Black



- Made of heavy-duty 1.5" (3.8 cm) diameter steel tubing.
- Inside and outside anti-corrosion coating with durable powder coat finish.
- Protect vehicle's rocker panels and undercarriage against large obstacles.
- Sold in pairs.

INTRUSION BARS

Front Intrusion Bar

Maverick Trail, Maverick Sport,
Maverick Sport MAX

715003872



- Steel intrusion bar matches perfectly with vehicle's styling.
- Inside and outside anti-corrosion coating with durable powder coat finish.
- Provides additional protection by preventing large objects from entering the driver/passenger area.

- Tube design reduces obstructed lines of sight and blind spots for better visibility.
- Not compatible with windshields and Soft Door Panels.

Lonestar Racing Rear Intrusion Bar

Maverick Trail, Maverick Sport

■ **715005134** - Black
 ■ **715004874** - Can-Am Red



- Race-engineered to Lonestar Racing's trademark standards for toughness, these stylishly crafted accessories will also enhance your vehicle with visual impact.
- Made of 1.5" (3,8 cm) diameter steel tubing with durable powder coat finish.
- Provides additional protection for driver and passenger.
- Not compatible with the Sport Roof, rear panels and windows, All-Terrain Trunk Cover.
- Not compatible with X mr models or with the Snorkel Kit.
- Not compatible with S&B particle separator.

2" (51 mm) Fender Flares

Maverick Trail

715004958

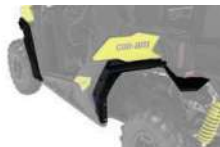

- Extended fender flares made from injection-molded polypropylene.
- Keep mud and debris out of vehicle.
- Designed for quick and easy installation.
- Include front and rear extensions, mounting hardware and Fender Flare Rear Extensions (715004404).
- Increase vehicle's overall width by 3.5" (8,9 cm).

3" (76 mm) Fender Flares

Maverick Trail, Maverick Sport, Maverick Sport MAX

715004959



- Fender flares made from injection-molded polypropylene.
- Keep mud and debris out of vehicle.
- Designed for quick and easy installation.
- Include front and rear extensions and mounting hardware.
- Increase vehicle's overall width by 6" (15,3 cm) when installed on Maverick Trail models.

Fender Flare Rear Extensions

Maverick Trail, Maverick Sport, Maverick Sport MAX

715004462



- Block terrain debris from kicking up onto you as you ride or damaging your vehicle thanks to these extra-large Fender Flare Extensions, which also include Rear Extensions (715004404) for added protection from mud/snow, especially when riding with track kits.
- Made from injection-molded polypropylene for best fit and finish.
- Not compatible with 2" (51 mm) Fender Flares.
- Include front and rear extensions.
- For Maverick Trail, must be used with 3" (76 mm) Fender Flares (715004959).
- Standard on Maverick Sport X mr models.

OTHERS

License Plate Holder

Maverick Trail, Maverick Sport, Maverick Sport MAX

715007006



- Supports your license plate on the Rear Trail Bumper.
- Plate lights can be relocated on bumper to light up license plate.
- Require Rear Trail Bumper (715007109) for installation.
- CE Compliant.

Tail Light Protectors

Maverick Trail, Maverick Sport, Maverick Sport MAX

715003692



- Anti-corrosion coating with durable powder coat finish.
- Rugged style, aggressive look.
- Sold in pairs.

Installation of some accessories shown may impact vehicle compliance with some regulations. Consult your local dealer for information.

Radiator Protector

Maverick Trail, Maverick Sport, Maverick Sport MAX

715003700

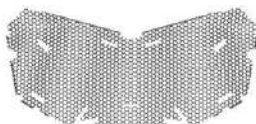

- Perforated steel shield mounted over the radiator face, providing protection from stones and branches.
- Not recommended for winter use.

LINQ: EASY ON, EASY OFF CARGO

MAVERICK'S LINQ ACCESSORIES

MOUNTING LOCATION AND REQUIREMENTS

<ul style="list-style-type: none"> • No tools needed: Quickly install and remove accessories by hand. • Equip your Can-Am for specialized tasks in no time. • Sturdy mounting system that holds up to the roughest terrain. 	Vehicle Standard Cargo Box	LinQ Cargo Rack 715003702	Adventure Roof Rack 715004095	LinQ Pivoting Rack 715010787	All-Terrain Trunk Cover 715003701	Passenger Seat Base
LinQ ACCESSORIES WITH 16" BASE LinQ anchors mounted 16 inches apart, center-to-center. Lower loading capacity than the LinQ with 36" base accessories. Can be used on Can-Am ATV and SxS vehicles, Can-Am Spyder and Ryker vehicles, Sea-Doo watercraft and Ski-Doo snowmobiles.						
NEW LinQ Rigid Cooler 4.7 US Gal (18 L) 715010491	LinQ Base Installation Kit 715008125	LinQ Base Installation Kit 715008125	LinQ Base Installation Kit 715008125			
NEW LinQ Cooler 5.3 US Gal (20 L) 295101257 • Gray				No compatibility	No compatibility	No compatibility
LinQ LinQ 11.4 US Gal (43 L) Cooler 715007825 • Black 715009276 • Gray	Need to remove unused toe-in of the cooler to fit properly (Refer to instruction sheet)	No compatibility	No compatibility			
LinQ 4.2 Gal Cooler 295100698 • White 219400964 • Black	LinQ Base Installation Kit 715008125		LinQ Base Installation Kit 715008125	LinQ Anchor Adapter Kit 715004960	LinQ Base Installation Kit 715008125	Passenger Seat LinQ Anchor Kit 715003951
LinQ Tool Kit 715006829	No further requirements					
LinQ Tool Box 715008111						
LinQ SR 5.5 Gal (21 L) Bag 860202449	LinQ Base Installation Kit 715008125	No compatibility	LinQ Base Installation Kit 715008125	LinQ Anchor Adapter Kit 715004960	LinQ Base Installation Kit 715008125	Passenger Seat LinQ Anchor Kit 715003951
LinQ 4.5 Gal (17 L) Sport Bag 860202447						
LinQ Modular Box 715005494 • (10 L) 715007112 • (20 L) 715006830 • (30 L)	No further requirements					
LinQ Roll-Top Bag 715008110				LinQ Anchor Adapter Kit 715004960		
LinQ 26 US Gal (100 L) Explorer Bag 295101016	LinQ Base Installation Kit 715008125	No compatibility	LinQ Base Installation Kit 715008125	No compatibility	LinQ Base Installation Kit 715008125	Passenger Seat LinQ Anchor Kit 715003951
LinQ 5.3 US Gal (20 L) Semi-Rigid Cooler 295101252						
LinQ ACCESSORIES WITH 36" BASE Mount on LinQ racks often used by Can-Am ORV vehicles. Higher loading capacity than the LinQ with 16" base accessories. Usage is limited to Can-Am ORV vehicles.						
LinQ 12 Gal (45 L) Cargo Box 715003879		No further requirements				
LinQ 23 Gal (86 L) Trunk Box 715004923		No compatibility				
LinQ 32 Gal (121 L) Trunk Box 715001747		No compatibility				
LinQ Audio Box 715003018	No compatibility	No further requirements	No compatibility	No further requirements	No compatibility	No compatibility
LinQ Cooler 715004778 • Black		No compatibility				
LinQ OGIO Bag 715002923 • Black						
LinQ Heavy Duty Basket 715001215		No further requirements				
LinQ Low Profile Basket 715004282						
LinQ HOLDERS						
LinQ Gear Grips 715005340	No further requirements (when installed on side walls)	No compatibility	Side wall installation LinQ Adapters 715003058	No further requirements	LinQ Base Installation Kit 715008125	No further requirements
LinQ Tool Holder 715007358						

The LinQ system is BRP's game-changing, tool-free cargo solution. Snap gear on or off in seconds. No fuss, no rattle, just rock-solid mounting on any terrain.

LINQ SYSTEM ADVANTAGE

ORIGINAL LinQ SYSTEM

Handles medium- to large-sized gear with two anchor setups: the 16" base for standard accessories and the 36" base for racks and serious payloads.

LinQ LITE

Made for smaller items, lightweight gear you can hang from rails or vertical mounts.



LinQ ACCESSORIES WITH 16" BASE

NEW LinQ Rigid Cooler 4.7 US Gal (18 L)

Maverick Trail, Maverick Sport, Maverick Sport MAX

715010491



- Versatile LinQ 16" configuration fits many vehicles.
- Durable rotomolded rigid construction.
- Molded-in handles for quick installation and removal.
- High quality insulation for optimal ice retention.
- Sealed lid for airtight, weather-tight closure.
- Ergonomic and secure latch system offers excellent sealing.
- 4.7 US gal (18 L) capacity.

NEW LinQ Cooler 5.3 US Gal (20 L)

Maverick Trail, Maverick Sport, Maverick Sport MAX

295101257



- LinQ-mounted for fast, easy and secure storage.
- Locks in place with just a quarter turn.
- High-quality insulation for optimal ice retention.
- Keeps ice cold for 5 days.
- Rotomolded construction for exceptional rigidity and durability.
- Sealed lid for airtight, weather-tight closure.
- Rigid handles make transportation easy.
- Horizontal locking handles allow for installation of LinQ Lite accessories.
- Marinized hardware suited for saltwater applications.
- Holds thirty-four 355 ml cans.
- 5.3 US gal (20 L) capacity.
- Exterior dimensions: 21" L x 15" W x 14" H (52 cm L x 38 cm W x 35 cm H)
- Interior dimensions: 15" L x 10" W x 9" H (39 cm L x 26 cm W x 23 cm H)
- See table for installation location and requirements.

Note: Cannot be mounted on the LinQ Stackable Fuel Caddy.

LinQ 11.4 US Gal (43 L) Cooler

Maverick Trail, Maverick Sport,
Maverick Sport MAX

■ **715007825** • Black
■ **715009276** • Gray



- Versatile LinQ 16" configuration fits many vehicles.
- High quality injection-molded impact resistant polypropylene outer shell for exceptional durability.
- High quality insulation for optimal ice retention.
- Thicker insulation on bottom to isolate vehicle heat.
- 11.4 US gal (43 L) capacity.
- LinQ-mounted for fast, easy, secure storage.
- Locks in place with only a quarter turn.
- Rigid handles make transportation easy.
- Horizontal locking handles allow installation of LinQ Lite accessories.
- Dry-basket included to protect items.
- Drain plug at the bottom to evacuate water.
- New ergonomic and secure latch system offers excellent sealing.
- Possibility to lock the cooler with a padlock.
- LinQ Cargo Base Kit (715008125) required for installation.
- See table for installation location and requirements.

LinQ Modular Box

Maverick Trail, Maverick Sport,
Maverick Sport MAX

715005494 • (10 L)
715007112 • (20 L)
715006830 • (30 L)



- Allows stacking of other modular boxes to always have the right gear accessible.
- Always have the right box size to fit everything.
- Can be installed on any LinQ base with a 16" width.
- See table for installation location and requirements.

Thermal Insert for LinQ Modular Box (10 L)

Maverick Trail, Maverick Sport,
Maverick Sport MAX

219401110



- Insulated liner.
- Fits very well in the LinQ Modular Box (10 L).
- Can contain seven 355 ml cans.
- Keeps ice cold for one day.
- Interior dimensions: 9" L x 17" W x 2½" H.

LinQ Tool Box

Maverick Trail, Maverick Sport,
Maverick Sport MAX

715008111



- High precision injected HDPE construction provides rigidity and durability.
- 5 gal (19 L) maximum capacity.
- Weather-resistant, sealed and lockable cover.
- Easy one-second on/off tool-less system.
- All the benefits of LinQ—simple, fast and secure.
- See table for installation location and requirements.

LinQ Tool Kit

Maverick Trail, Maverick Sport,
Maverick Sport MAX

715006829



- Includes:
- Cutter pliers
 - Long-nose pliers
 - Locking pliers
 - Ratchet wrench ¾" drive
 - 6" ratchet extension
 - Integrated CVT belt storage location (belt not included)
 - Long-socket 19 mm ¾" drive – 6 pts
 - Socket 18 mm ¾" drive
 - Long-socket 17 mm ¾" drive – 6 pts
 - Socket 15 mm ¾" drive
 - Socket 13 mm ¾" drive
 - Socket 10 mm ¾" drive
 - Socket 8 mm ¾" drive
 - Socket Torx T40 ¾" drive
 - Socket Torx T30 ¾" drive
 - Socket Torx T20 ¾" drive
 - Breaker bar ¾" drive
 - Combination Wrench set:
 - Wrench 19 mm
 - Wrench 18 mm
 - Wrench 15 mm
 - Wrench 13 mm
 - Wrench 10 mm
 - Wrench 8 mm
- See table for installation location and requirements.

LinQ 4.2 Gal (16 L) Cooler

Maverick Trail, Maverick Sport,
Maverick Sport MAX

■ **219400964** • Black
■ **295100698** • White



- All the benefits of LinQ—simple, fast and secure.
- Rotomolded construction for exceptional rigidity and durability.
- Premium-quality foam insulation for optimal ice retention.
- Uses LinQ mounting system (Patent US 8777531 and US 8875830).
- Easy one-second on/off tool-less system.
- Can contain twenty 355 ml cans.
- Keeps ice cold for three days.
- Exterior dimensions: 13" L x 20" W x 10" H.
- Interior dimensions: 9" L x 17" W x 7" H.
- See table for installation location and requirements.

NEW LinQ 5.3 US Gal (20 L) Semi-Rigid CoolerMaverick Trail, Maverick Sport,
Maverick Sport MAX**295101252**

- 5.3 US gal (20 L) of insulated, water-resistant capacity.
- Quick, easy and secure LinQ system installation.
- Attaches with one set of LinQ fasteners.
- Single-day-use soft cooler.
- Mesh pocket on top of the lid.
- Zippered pocket under the lid for quick and easy access.
- Removable interior for easy cleaning.
- Carry handles for easy transport.
- Can contain twelve 355 ml cans.
- Dimensions: 19" L x 13" W x 10" H.

LinQ 4.5 Gal (17 L) Sport BagMaverick Trail, Maverick Sport,
Maverick Sport MAX**860202447**

- All the benefits of LinQ—simple, fast and secure.
- 17 liter (4.5 US gallon) capacity.
- Thermoformed bag base in HDPE (High Density Polyethylene) providing rigidity and durability.
- Rigid bottom, semi-rigid top.
- Easy one-second on/off tool-less system.
- See table for installation location and requirements.

SR 5.5 Gal (21 L) LinQ BagMaverick Trail, Maverick Sport,
Maverick Sport MAX**860202449**

- All the benefits of LinQ—simple, fast and secure.
- Semi-rigid expandable bag.
- 5.5 gal (21 L) capacity.
- Utilizes LinQ mounting system (Patent US 8777531 and US 8875830).
- Easy one-second on/off tool-less system.
- See table for installation location and requirements.

LinQ Roll-Top BagMaverick Trail, Maverick Sport,
Maverick Sport MAX**715008110**

- Fully waterproof roll-top dry bag will securely store and confine your equipment.
- LinQ mounted using heavy-duty rigid plastic base.
- High capacity storage solution (40 L).
- Bottom foam liner for additional equipment protection.
- Integrated handle for easy transportation on/off the vehicle.
- Dimensions: 14" L x 19" W x adjustable H.
- See table for installation location and requirements.

LinQ Explorer BagMaverick Trail, Maverick Sport,
Maverick Sport MAX**295101016**

- 26 gal (100 L) of watertight storage.
- Installs in seconds with tool-less LinQ accessory system.
- Dedicated essentials compartment for registration, license, insurance and more.
- Exclusive D.E.S.S. key storage.
- External quick-access pocket for small items like keys and wallets.
- Turns into a backpack when you get off your machine.
- Collapsible if not fully packed with straps on both sides.
- Dimensions: 26" L x 18" W x 14" H.
- Not compatible with LinQ Pivoting Rack (715010787).

LinQ ACCESSORIES WITH 36" BASE**LinQ Premium Storage Bag by OGIO**Maverick Trail, Maverick Sport,
Maverick Sport MAX**■ 715002923 • Black**

- Tool-less installation and removal thanks to the LinQ system.
- 17.2 gal (65 L) capacity semi-rigid cargo bag ideal for carrying anything you need on your vehicle.
- Buckle and elastic closure with a rubber seal that prevents dust from entering the bag.
- 3-section lid for partial or full access to your bag.
- Inside separators for optimal bag organization.
- See table for installation location and requirements.

LinQ 12 Gal (45 L) Cargo BoxMaverick Trail, Maverick Sport,
Maverick Sport MAX**715003879**

- LinQ mounted for easy-on, easy-off installation.
- Holds cargo safely and securely while riding.
- See table for installation location and requirements.

LinQ 23 Gal (86 L) Trunk Box	Maverick Trail, Maverick Sport, Maverick Sport MAX	715004923
-------------------------------------	--	------------------



- LinQ mounted for easy-on, easy-off installation.
- Holds cargo safely and securely while riding.
- See table for installation location and requirements.

LinQ 11.5 Gal (43 L) Audio Cargo Box	Maverick Trail, Maverick Sport, Maverick Sport MAX	715003018
---	--	------------------



- An affordable and quick solution for adding music and storage to your next ride.
- The rear installation does not use up any cab space and allows easy listening at an average speed.
- Mounts on/off easily to hold/carry cargo safely and securely.
- Backlit control panel perfect for night riding.
- Water-resistant speakers.
- The Bluetooth[®] enabled receiver and 6.5" (16.5 cm) speakers are smartly concealed and integrated in the cover.
- Automatic shut-off function protects your battery by turning the system off after 10 minutes of inactivity.
- See table for installation location and requirements.

LinQ 8 Gal (30 L) Cooler Box	Maverick Trail, Maverick Sport, Maverick Sport MAX	■ 715004778 • Black
-------------------------------------	--	----------------------------



- LinQ mounted for easy-on, easy-off installation.
- Rotomolded construction provides exceptional rigidity and durability.
- Premium-quality foam insulation for optimal ice retention.
- Integrated, fully removable compartment protects food.
- Robust rubber latches keep the cover tightly closed.
- Weather-resistant.
- Convenient drain plug.
- See table for installation location and requirements.

LinQ 32 Gal (121 L) Trunk Box	Maverick Trail, Maverick Sport, Maverick Sport MAX	715001747 • Black (Rear tail light included)
	European Version (EC compliant)	715001748 • (No rear tail light)



- Equipped with the LinQ system, the rear trunk box plugs in and out in seconds.
- 32 gal (121 L) load capacity with unobstructed space to maximize storage room and access to the trunk's interior.
- Made of injection-molded polyethylene, double walled in critical areas.
- The fully sealed lid protects your belongings from dust, moisture and the elements.
- Trunk Box Panels available in many colors to match your vehicle (sold separately).
- See table for installation location and requirements.

LinQ 32 Gal (121 L) Trunk Box Panels	Maverick Trail, Maverick Sport, Maverick Sport MAX	
---	--	--

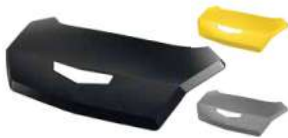

- Color panels to match the LinQ 32 gal (121 L) to your vehicle (715001747 / 715001748).
- | | |
|--|---|
| <ul style="list-style-type: none"> ■ 715001391 • Black ■ 715001392 • Yellow ■ 715001395 • Viper Red ■ 715002481 • White ■ 715002480 • Light Gray ■ 715002984 • Octane Blue ■ 715002985 • Manta Green ■ 715002986 • Can-Am Red ■ 715006119 • Orange Crush ■ 715006120 • Squadron Green ■ 715007074 • Tundra Green | <ul style="list-style-type: none"> European Version (EC compliant). No rear tail light. ■ 715001397 • Black ■ 715001398 • Yellow ■ 715002483 • White ■ 715006121 • Can-Am Red ■ 715006123 • Orange Crush ■ 715006124 • Viper Red |
|--|---|

LinQ Heavy-Duty Basket	Maverick Trail, Maverick Sport, Maverick Sport MAX	715001215
-------------------------------	--	------------------



- Made of high-strength, low-alloy steel.
- LinQ mount for easy-on, easy-off installation.
- See table for installation location and requirements.

LinQ Low Profile Basket	Maverick Trail, Maverick Sport, Maverick Sport MAX	715004282
--------------------------------	--	------------------



- Low profile, open basket increases cargo space.
- Perfect for easy access to tools, rope, winch and plow accessories.
- Multiple bungee cord and tie-down anchor points.
- Made of impact-resistant injected polypropylene.
- See table for installation location and requirements.

LinQ HOLDERS

LinQ Tool Holder

Maverick Trail, Maverick Sport,
Maverick Sport MAX

715007358



- Ultra-versatile tool holder.
- Convenient swivel-latch allows tools to be stored in any orientation.
- Sold in pairs.

LinQ Gear Grips

Maverick Trail, Maverick Sport,
Maverick Sport MAX

715005340



- Durable and flexible grips provide a custom fit for a variety of items from 1" to 4" (2.5 cm to 10 cm) in diameter.
- Heavy-duty design for carrying bows, fishing poles, rakes, farm tools and more.
- Quick-release button opens grip quickly for easy access to gear.
- Heavy-duty base system built for the toughest adventures.
- Make transporting your tools a snap by combining the Gear Grips with the LinQ system.
- 360° orientation.
- Sold in pairs.

LinQ ACCESSORIES

LinQ Adapter

Maverick Trail, Maverick Sport,
Maverick Sport MAX

715003058



- Sold in pack of 4.

LinQ Base Installation Kit

Maverick Trail, Maverick Sport,
Maverick Sport MAX

715008125



- Unique mounting fastener usable on any LinQ system accessory.
- Included: 2 cargo LinQ bases and hardware.

LinQ Lock

Maverick Trail, Maverick Sport,
Maverick Sport MAX

860201968



- Simple way to securely lock most LinQ accessories.
- Lock cover protects lock from the elements.
- Corrosion resistant.
- Pack of 1, includes 2 keys.
- Not compatible with LinQ 4.2 US Gal (16 L) Cooler, LinQ Tool Box, LinQ Tool Holder and LinQ Gear Grips.

LinQ Replacement Part

Maverick Trail, Maverick Sport,
Maverick Sport MAX

715010798



- Unique mounting fastener usable on any LinQ system accessory.
- Tool-less installation and removal.
- Sold in pairs.

LinQ Anchor Adapter kit

Maverick Trail, Maverick Sport,
Maverick Sport MAX

715004960



- Allows the installation of LinQ accessories with 16" base on LinQ racks.
- Tool-less installation and removal.
- LinQ pivoting rack is required for installation.

CARGO & STORAGE

CARGO

All-Terrain Trunk Cover

Maverick Trail, Maverick Sport (except X mr),
Maverick Sport MAX

715003701



- Transforms your rear cargo area into a fully enclosed and weather-resistant car-like trunk box.
- Gas spring assisted opening.
- Integrated mounting location inside the trunk cover for Dome Light (715009228) (sold separately).
- Rotomolded construction provides exceptional rigidity.
- LinQ accessories can be installed on or inside the trunk cover.
- LinQ Base Installation Kit required for installation on the trunk cover.

STORAGE

Soft Storage Bag

Maverick Trail, Maverick Sport,
Maverick Sport MAX

715003759



- 11.8 gal (45 L) capacity soft cargo bag designed with vehicle's rear in mind to maximize potential storage.
- 3-section bag.
- Transport gear in a weatherproof bag.

Storage 2.6 Gal (10 L) Bag

Maverick Trail, Maverick Sport,
Maverick Sport MAX

269502121



- Roll-top dry bag for fully protecting your cargo from the elements.

Overhead Storage Bags

Maverick Trail, Maverick Sport,
Maverick Sport MAX

715005018



- Weather-resistant bags, hold your gear safely and securely while riding.
- Include 2 overhead soft bags mounted on a tubular frame that sits between cage and roof.
- 2.4 gal (9 L) total capacity.
- Bimini Roof with Sun Visor or Sport Roof needed for installation.
- Not compatible with the Complete Wet Sounds Audio System.

Shoulder Storage Bag

Maverick Trail, Maverick Sport,
Maverick Sport MAX

715005019



- Weather-resistant semi-rigid bag holds your gear safely and securely while riding.
- Bag attaches in unused space between the seats to increase your vehicle's cargo capacity.
- 2.8 gal (10.5 L) capacity.

Removable Central Storage Bag

Maverick Sport MAX

715004794



- Weather-resistant bag holds your gear safely and securely while riding.
- Both front and rear passengers can access the bag's contents.
- Designed as a 1.3 gal (5.2 L) capacity pocket, also equipped with inner netting compartments and side pockets.
- Can be removed in seconds and includes shoulder strap for transportation.
- Perfect to bring your gear on and off your vehicle.

Passenger Storage Seat Bag

Maverick Trail, Maverick Sport, Maverick
Sport MAX

715008080



- This weather-resistant bag holds your gear safely and securely while you ride.
- Bag settling on the passenger's seat to increase the vehicle's cargo capacity.
- This bag features a 14.5 gal (55 L) storage capacity and is divided into two compartments.
- The top compartment is insulated to keep your beverages cold and includes two cup holders.
- Additional pocket inside for additional storage, such as a cell phone.
- The bottom compartment is accessible from both sides and serves as a large pocket for storing various items.
- The detachable pocket at the front of the bag can be used as a garbage bag.

Soft Cooler

Maverick Trail, Maverick Sport,
Maverick Sport MAX

715003728



- Soft cooler made of durable canvas.
- Removable shoulder strap and carry handles.
- Foam insulation and water-resistant interior liner.
- 2.2 gal (4.5 L) capacity.

RACKS & HOLDERS

Adventure Roof Rack

Maverick Sport MAX

715004095



- Ideal cargo solution for packing everything you need to live your off-road experience fully and completely.
- Built with heavy-duty 1.5" (3.8 cm) and 1.25" (3.2 cm) diameter steel tubing.
- Loads of up to 75 lb (34 kg).
- LinQ support plates allow for installation of accessories with 16" base.
- Integrated mounting points for the installation of the 39" (99 cm) Double Stacked LED Bar (front).
- Features anchor points for spare tire attachment.
- Spare Tire Tie-Downs sold separately.
- Add the Cargo Box Net to secure and confine your cargo in the rack.
- Can be installed without a roof or with Sport Roof only.

LinQ Pivoting Rack

Maverick Trail, Maverick Sport,
Maverick Sport MAX

715010787



- LinQ latched rack allows for extra LinQ mounted accessories or the addition of ATV LinQ rack extensions.
- Includes custom tie-down strap for fast spare tire installation or removal (tire not included).
- Gas-cylinder pivot action, locks in the raised position.
- Not compatible with Gear Rail (715003703), Lonestar Racing and DragonFire tire carrier, Lonestar Racing Number Plate, Rear Intrusion Bars and LinQ Cargo Rack.
- Compatible with the All-Terrain Trunk Cover.

LinQ Rack Extension

Maverick Trail, Maverick Sport,
Maverick Sport MAX

715003771



- Made of strong and durable die-cast-aluminum.
- Helps to keep cargo securely in place.
- Easy and tool-less installation thanks to the LinQ system.

LinQ Cargo Rack

Maverick Trail, Maverick Sport,
Maverick Sport MAX

715003702



- Made of durable die-cast aluminum and strong aluminum tubing frame.
- Allows the installation of LinQ Trunk Boxes on top and the addition of more LinQ accessories in cargo box.
- Easy and tool-less installation thanks to the LinQ system.

Spare Tire Carrier

Maverick Trail, Maverick Sport,
Maverick Sport MAX

715004471



- Holds spare tire in place.
- Designed for fast tire removal.
- Can hold tires up to 30" in diameter (tire is not included).
- Rear bumper mounted, does not encumber the cargo area.
- Made of heavy-duty 1.5" (3.8 cm) diameter steel tubing.
- Inside and outside anti-corrosion coating with durable powder coat finish.
- Requires Rear Trail Bumper (715007109) or Rear Rancher Bumper (715004304).









Cargo Box Net

Maverick Sport MAX

715001371



- Solid net designed to secure and ensure the compact confinement of your Adventure Roof Rack.

LinQ Gun Case	Maverick Trail, Maverick Sport, Maverick Sport MAX	715009240
	<ul style="list-style-type: none"> Practical design allows you to store shotguns and rifles up to 52" (132 cm) even with optics. Adapt to different weapon shapes and features with foam cushions that can be repositioned. LinQ-mounted for efficient and secure storage, locked in place with only a quarter turn. Mount kit required for Maverick Trail, Maverick Sport and Maverick Sport MAX. 	
LinQ Gun Case Mounting Kit	Maverick Sport, Maverick Sport MAX, Maverick Trail	715006444
	<ul style="list-style-type: none"> Required to install the Can-Am Gun Case on a Maverick Sport, Maverick Sport MAX and Maverick Trail. Allows you to install up to two LinQ gun cases. 	
Gear Rail	Maverick Trail, Maverick Sport, Maverick Sport MAX	715003703
	<ul style="list-style-type: none"> Sturdy gear rail design with C-clamps attached on the roll cage. Offers mounting points for the Stronghold Auto-Latch Mount or for the Universal Saw Press by Kolpin. Can hold up to two gun boots. Not compatible with the Gun Boot 6.0 Impact by Kolpin (715001419). 	
Universal Saw Press by Kolpin	Maverick Trail, Maverick Sport, Maverick Sport MAX	715001423
	<ul style="list-style-type: none"> Specially crafted for transporting your chainsaw securely and safely aboard your side-by-side vehicle. Heavy-duty, black powder-coated metal bracket designed to attach any chainsaw model with up to a 20" (51 cm) bar. Rubber pads provide cushion and tight fit. Hinged design for quick removal. Holds saw in vertical position or 45° angle in either direction. Requires Gear Rail (715003703). Protective sheath included. 	
Spare Tire Ratchet Tie-Downs	Maverick Trail, Maverick Sport, Maverick Sport MAX	280000955
	<ul style="list-style-type: none"> 3-way ratcheting tie-down strap with loop ends. Designed to securely hold spare tires on accessories equipped with integrated spare tire attachment points. Adjustable to accommodate most common UTV tire sizes. Ratchet and junction ring made of durable zinc-plated steel. Required for spare tire attachment on Adventure Roof Rack and LinQ Pivoting Rack. 	
Heavy-Duty Ratchet Tie-Down	Maverick Trail, Maverick Sport, Maverick Sport MAX	715008308
	<ul style="list-style-type: none"> 1,000 lb (454 kg) safe working load. 1.5 in. x 6 in. (38 mm x 1.8 mm) strap with BRP brands. Deluxe ratchet with rubber handle. Black-coated clip hooks. 12" (300 mm) webbing included. Pack of two. 	
Bolt-On[†] Retractable Ratcheting Tie-Downs	Maverick Trail, Maverick Sport, Maverick Sport MAX	295101072
	<ul style="list-style-type: none"> Perfect for transporting your powersport vehicle or securing loads. Mounts easily: Bolts on any flat surface (e.g., truck bed or frame). 1" x 6' (2.5 cm x 1.8 m) tie-down strap with heavy-duty stitching that delivers a 500 lb (226 kg) working load strength and 1,500 lb (680 kg) break strength. Convenient retractable push button automatically slackens, spools and stores away strap, while the ratchet mechanism tightens the strap snugly to secure your vehicle or load into place. Rubber ratcheting handle provides firm grip, and the hook is vinyl coated to protect whatever surface it hooks into. Sold in pairs. 	
Ratchet Tie-Downs	Maverick Trail, Maverick Sport, Maverick Sport MAX	715008309 • Black/Gray
	<ul style="list-style-type: none"> 400 lb (181 kg) safe working load. 1" x 10' (2.5 cm x 3 m) strap with Sea-Doo, Ski-Doo and Can-Am logos. Deluxe ratchet with rubber handle. Coated S hooks. Pack of 2. 	

LIGHTS

CAN-AM LIGHTS

1 CHOOSE YOUR MOUNT POINT	2 CHOOSE YOUR LIGHTS						
	10" Double Stacked LED Bar 715002933	15" Double Stacked LED Bar 715002934	39" Double Stacked LED Bar 715004007	4" Round LED Lights (sold in pairs) 715002935	3.5" Spot or Flood LED Lights (sold in pairs) 715010093 /715010094	SMART 40" (102 cm) LED Light Bar 715008747	SMART 10" (25 cm) LED Light Bar 715008745
S3⁺ Front Bumper 715005121 & Trail Bumper 715003680, 715003681	715003670 (Power Cable)	No compatibility	No compatibility	715003670 (Power Cable)		No compatibility	715009886 (Lights Wiring Harness)
Sport Roof & Bimini Roof	715003670 (Power Cable) + 715003669 (Overhead Switch Panel)	715003669 (Overhead Switch Panel)	715005822 (Mounting Kit) *Optional Overhead Switch Panel 715003669	715003669 (Overhead Switch Panel)		715011297 (LED Light Bar Mounting Kit) + 715003669 (Overhead Switch Panel) + 715009930 (LED Light Bar Harness)	715011297 (LED Light Bar Mounting Kit) + 715003669 (Overhead Switch Panel) + 715009886 (Lights Wiring Harness)
Top Roll Cage	No compatibility	No compatibility	715005822 (Mounting Kit)	No compatibility	No compatibility	No compatibility	No compatibility
Sport Roof Back Position			No compatibility		715004910 (Power Cable) + 715003669 (Overhead Switch Panel)		

BAJA DESIGNS⁺ LIGHTS

1 CHOOSE YOUR MOUNT POINT	2 CHOOSE YOUR LIGHTS			
	10" (25 cm) LED Light Bar 715006819	XL Sport LED Lights (sold in pairs) 710006821	Squadron Sport LED Lights (sold in pairs) 710006820	XL80 LED Lights (sold in pairs) 710005041
S3⁺ Front Bumper 715005121 & Trail Bumper 715003680, 715003681	No compatibility	715008865 (Power Cable)	715008865 (Power Cable)	715007049 (Power Cable)
Sport Roof & Bimini Roof	715007049 (Power Cable) *Optional Overhead Switch Panel 715003669	715008865 (Power Cable) *Optional Overhead Switch Panel 715003669	715008865 (Power Cable) *Optional Overhead Switch Panel 715003669	715007049 (Power Cable) *Optional Overhead Switch Panel 715003669
Top Roll Cage	No compatibility	No compatibility	No compatibility	No compatibility
Sport Roof Back Position				
3 ORDER	ORDER ALL PART NUMBERS IN INTERSECTING BOX *Note: When installing more than one light kit, additional light power cable or mounting kit is required.			

*All lights are intended for off-road use only.

NEW SMART 10" (25 cm) LED Light Bar	Maverick Trail, Maverick Sport, Maverick Sport MAX	715008745
--	--	------------------



- The perfect combination of powerful white and selective yellow LEDs.
- The selective yellow LEDs are ideal for driving in low visibility conditions.
- The light is composed of 16 white LEDs and 8 yellow LEDs.
- Spot and Flood combo beam.
- The side lens design provides highly effective wide-angle illumination.
- The white LEDs produce 8,100 raw lumens and the selective yellow 2,640 raw lumens, delivering stunning lighting performance.
- The lens is made from hard-coated polycarbonate.
- IP67 and IP69k submersible and pressure washer safe.
- Switch options: Off, Low and High. Color change by flicking the switch quickly.
- Lights Wiring Harness (715009886) is required for installation. Sold separately.
- See table for installation location and requirements.
- ECE Certified

NEW SMART 40" (102 cm) LED Light Bar	Maverick Trail, Maverick Sport, Maverick Sport MAX	715008747
---	--	------------------



- The perfect combination of powerful white or selective yellow LEDs.
- The selective yellow LEDs are ideal for driving in low visibility conditions.
- The light is composed of 64 white LEDs and 32 yellow LEDs.
- Spot and Flood combo beam.
- The side lens design provides highly effective wide-angle illumination.
- The white LEDs produce 32,000 raw lumens and the selective yellow 10,560 raw lumens, delivering stunning lighting performance.
- The lens is made from hard-coated polycarbonate.
- IP67 and IP69k submersible and pressure washer safe.
- Switch options: Off, Low and High. Color change by flicking the switch quickly.
- Wiring harness (715009930) is required for installation. Sold separately.
- See table for installation location and requirements.
- ECE Certified

10" (25 cm) Double Stacked LED Light Bar (60 W)	Maverick Trail, Maverick Sport, Maverick Sport MAX	715002933
--	--	------------------

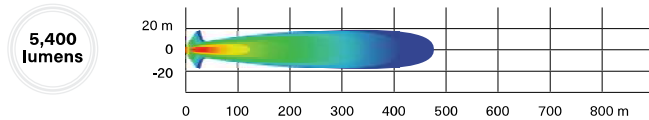

- Equipped with twelve 5 W Cree LEDs.
- 5,400 lumens.
- Packs a big punch for its size.
- Rugged and waterproof.
- Can be installed in stock XT and XT-P bumpers.
- Requires light power cable for installation.
- Lights up to more than 1,500 ft (460 m) in front of the vehicle and around 65 ft (20 m) wide on each side.
- ECE Certified.
- See table for installation location and requirements.

15" (38 cm) Double Stacked LED Light Bar (90 W)	Maverick Trail, Maverick Sport, Maverick Sport Max	715002934
--	--	------------------

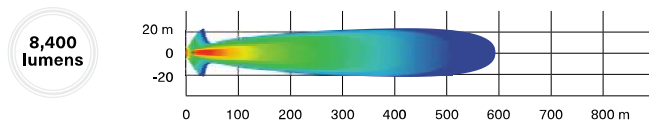

- Equipped with 18 5 W Cree LEDs.
- 8,400 lumens.
- Complements the Light Racks and most bumpers.
- Rugged and waterproof.
- Lights up to more than 1,900 ft (580 m) in front of the vehicle and around 65 ft (20 m) wide on each side.
- ECE Certified.
- See table for installation location and requirements.

39" (99 cm) Double Stacked LED Light Bar (270 W)	Maverick Trail, Maverick Sport, Maverick Sport Max	715004007
---	--	------------------

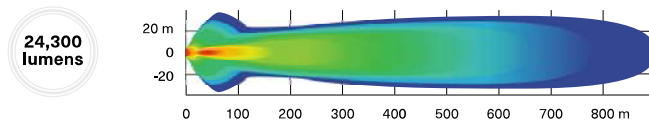

- Equipped with 54 5 W Cree LEDs.
- 24,300 lumens.
- Lights up to more than 2,900 ft. (900 m) in front of the vehicle and around 115 ft. (35 m) wide on each side.
- Compatible on the Adventure Roof Rack.
- See table for installation location and requirements.
- Not ECE Certified

Baja Designs 10" (25 cm) OnX6 LED Light Bar

Maverick Trail, Maverick Sport,
Maverick Sport Max

710006819



12,460 lumens

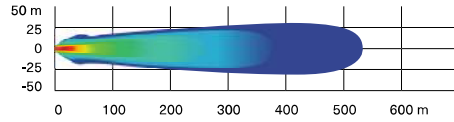

- 108 W light bar producing 12,460 lumens.
- Equipped with 6 Cree XM-L2 LEDs.
- Driving/combo light pattern for smooth blend of light for both near field applications and distance.

- Dual intensity (high/low) settings.
- Requires Baja Designs Light Power Cable.
- See table for installation location and requirements.

Baja Designs XL80 LED Lights

Maverick Trail, Maverick Sport,
Maverick Sport Max

710005041



9,500 lumens

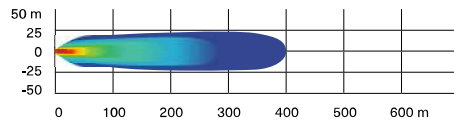

- 80 W per spot producing 9,500 lumens.
- Equipped with 4 Cree XHP50 LEDs per spot.
- Dual intensity (high/low) settings.
- Driving/combo light pattern for smooth blend of light for both near field applications and distance.

- Require Baja Designs Light Power Cable.
- Sold in pairs.
- Dimensions: 4.5" x 4.5" (11.4 cm x 11.4 cm).
- See table for installation location and requirements.

Baja Designs Squadron Sport LED Lights

Maverick Trail, Maverick Sport,
Maverick Sport Max

710006820



3,150 lumens

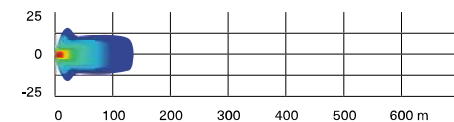

- 26 W per spot producing 3,150 lumens.
- Equipped with 4 Cree XP-G2 LEDs per spot.
- Wide cornering light pattern designed specifically for cornering, dust and/or fog conditions.

- Require Baja Designs Light Power Cable.
- Sold in pairs.
- Dimensions: 3" x 3" (7.6 cm x 7.6 cm).
- See table for installation location and requirements.

Baja Designs XL Sport LED Lights

Maverick Trail, Maverick Sport,
Maverick Sport Max

710006821



3,150 lumens

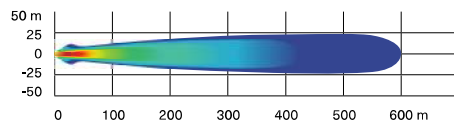

- 26 W per spot producing 3,150 lumens.
- Equipped with 4 Cree XP-G2 LEDs per spot.
- High Speed Spot features a longer and narrower beam focus for illumination farther down.

- Require Baja Designs Light Power Cable.
- Sold in pairs.
- Dimensions: 4.5" x 4.5" (11.4 cm x 11.4 cm).
- See table for installation location and requirements.

4" (10 cm) Round LED Lights (2 x 25 W)

Maverick Trail, Maverick Sport,
Maverick Sport Max

715002935



1,800 lumens

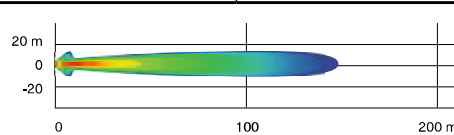

- 25 W LED spotlights.
- 1,800 lumens.
- Rugged and waterproof.
- Includes basic wiring and switch.
- Can-Am branded grill.

- Requires light power cable.
- Sold in pairs.
- Not ECE Certified.
- See table for installation location and requirements.

3.5" (9 cm) LED Driving Lights (2 x 14 W)

Maverick Trail, Maverick Sport,
Maverick Sport Max

715010094

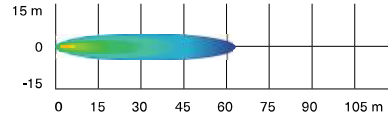

- 14 W LED lights producing 1,260 lumens each.
- Spot lens for a narrow and long light beam spread, ideal when driving at higher speeds.
- Equipped with six high-power LEDs in a heavy-duty die-cast aluminum housing.

- Features two attachment points. If one attachment point fails due to a collision, rotate to the next channel point and remount the light.
- Sold in pairs.
- ECE Certified.
- See table for installation location and requirements.

3.5" (9 cm) LED Flood Lights (2 x 14 W)

Maverick Trail, Maverick Sport,
Maverick Sport Max

715010093

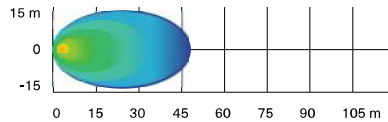

- 14 W LED lights producing 1,260 lumens each.
- Flood lens for a wide light beam spread, ideal for working applications like plowing or cornering. Suitable for dusty or foggy riding conditions.
- Equipped with six high-power LEDs in a heavy-duty die-cast aluminum housing.

- Features two attachment points. If one attachment point fails due to a collision, rotate to the next channel point and remount the light.
- Sold in pairs.
- ECE Certified.
- See table for installation location and requirements.

LED Headlights Assembly

Maverick Trail, Maverick Sport,
Maverick Sport MAX

715003667



- The headlights in this upgrade kit draw a maximum of 40 W (2 x 20 W) of power while providing brighter light output.
 - Lower power consumption and longer lasting than standard halogen bulbs.
- Installation of some accessories shown may impact vehicle compliance with some regulations. Consult your local dealer for information.*

Can-Am LED Signature Lights

Maverick Trail, Maverick Sport,
Maverick Sport MAX

715003673



- Add style with a more aggressive look.
 - Use bright and energy efficient LEDs.
 - Do not give additional lighting for driving.
- Installation of some accessories shown may impact vehicle compliance with some regulations. Consult your local dealer for information.*

NEW Dome Light

Maverick Trail, Maverick Sport,
Maverick Sport MAX

715009228



- Offers an optimal visibility in the cab and integrates perfectly with the vehicle.
- 160 lumens of soft white light ensure clear visibility of the surroundings.
- Built in on/off button on the light.
- Wiring included.
- Can be installed on cage, Sport Roof or All-Terrain Trunk Cover.

NEW SMART 40" (102 cm) LED Light Bar Harness*(Not illustrated)*Maverick Trail, Maverick Sport,
Maverick Sport MAX**715011297**

- Required to install the SMART 40" (102 cm) LED Light Bar (715008747).

Light Power Cable*(Not illustrated)*Maverick Trail, Maverick Sport,
Maverick Sport MAX**715003670**

- Power cable for installation of compatible Can-Am light kits on front bumpers or roof.

Mounting Kit for 39" (99 cm) LED Light Bar*(Not illustrated)*Maverick Trail, Maverick Sport,
Maverick Sport MAX**715005822**

- Required for installation of the 39" (99 cm) double stacked LED Light Bar.
- Includes wiring and support bracket.
- Light Support Bar required for installation.

NEW Lights Wiring HarnessMaverick Trail, Maverick Sport,
Maverick Sport MAX**715009886**

- Power cable for installation of the SMART 10" (25 cm) LED Light Bar (715008745).

Roof Power Cable*(Not illustrated)*Maverick Trail, Maverick Sport,
Maverick Sport MAX**715003094**

- Brings power from the battery.
- Required for installation of some electrical accessories.

Rear Lights Power Cable*(Not illustrated)*Maverick Trail, Maverick Sport,
Maverick Sport MAX**715004910**

- Power cable that allows you to install rear cargo lights on your vehicle.
- Use in conjunction with the 3.5" (9 cm) LED Flood Lights (2 x 14 W) (sold separately).
- This set-up will illuminate your rear cargo area and surroundings.
- Sport Roof and Overhead Switch Panel (715003669) required.

Baja Designs Light Power Cable*(Not illustrated)*Maverick Trail, Maverick Sport,
Maverick Sport MAX**715008865**

- Required for installation of Baja Designs LED lights onto roof or bumper.
- Baja Designs XL Sport LED Lights and Baja Designs Squadron Sport LED Lights.

Baja Designs Light Power Cable*(Not illustrated)*Maverick Trail, Maverick Sport, Maverick
Sport MAX**715007049**

- Required for installation of Baja Designs LED lights onto roof or bumper.
- 10" (25 cm) Baja Designs OnX6 LED Bars and Baja Designs XL80 LED Lights.

AUDIO & COMMUNICATION SYSTEMS

AUDIO

Can-Am Audio Roof	Maverick Trail, Maverick Sport	715006309
	<ul style="list-style-type: none"> • Full roof with premium JL Audio system. • Fully sealed and waterproof components and construction. • Simple to install: one connector connects the roof to the vehicle's electrical system. • Weatherproof components: Four 7.7" coaxial speakers, 280 watt amplifier and Mediamaster® source unit. • AM/FM tuner. • Expertly tuned for exceptional sound on the move. 	<ul style="list-style-type: none"> • Speakers include adjustable RGB LED cone illumination, controlled via an app on your smartphone. • Mediamaster® source unit equipped with 3" full-color LCD display, with day/night lighting modes. • Designed to not drain the battery. • Compatible with 39 in. (99 cm) Double Stacked LED Light Bar (270 W) (715004007). • Not compatible with Adventure Roof Rack or Overhead Switch Panel.

Can-Am Audio Roof MAX	Maverick Sport MAX	715006842
	<ul style="list-style-type: none"> • Full roof with premium JL Audio system. • Fully sealed and waterproof components and construction. • Simple to install: one connector connects the roof to the vehicle's electrical system. • Weatherproof components: Six 7.7" coaxial speakers, 280 watt amplifier and Mediamaster® source unit • AM/FM tuner. 	<ul style="list-style-type: none"> • Speakers include adjustable RGB LED cone illumination, controlled via an app on your smartphone. • Mediamaster® source unit equipped with 3" full-color LCD display, with day/night lighting modes. • Designed to not drain the battery. • Compatible with 39 in. (99 cm) Double Stacked LED Light Bar (270 W) (715004007). • Not compatible with Adventure Roof Rack.

Can-Am Audio Roof Flip Kit	Maverick Trail, Maverick Sport, Maverick Sport MAX	715007228
	<ul style="list-style-type: none"> • Combines with the Can-Am JL Audio Roof (715006309 or 715006842) for Flip option. • Not compatible with the Roof Rack. 	

Complete Wet Sounds[†] Audio System	Maverick Trail, Maverick Sport, Maverick Sport MAX	715003672
	<ul style="list-style-type: none"> • Orchestrated for outstanding sound quality and the playlists of champions. • Built-in 200 W amplifier with D-Bass Tech for improved low end bass response. • Built-in Bluetooth[†] connectivity with source control. • Aux input allows for use with non-Bluetooth devices. 	<ul style="list-style-type: none"> • Turns itself off after 10 minutes of inactivity to save battery power. • Designed to be Can-Am-tough in the most demanding riding conditions. • Includes 4.5" (11.4 cm) front and 6.5" (16.5 cm) rear-roll-cage mounted stereo speakers and console integrated backlit control panel.

Wetsound Stealth XT 6 Can-Am Edition Sound Bar	Maverick Trail, Maverick Sport, Maverick Sport MAX	715008282
	<ul style="list-style-type: none"> • Built-in Bluetooth connectivity with source control. • Built-in Broadcast mode. • Backlit control panel with Integrated LED RGB cabin lights. • Integrated LED Dome. • IP67 rated RF wireless remote control. • 3.5 aux input/output. • Built-in 300 W Class D amplifier. 	<ul style="list-style-type: none"> • 4 marine-rated 3" full range drivers. • 2 marine-rated 1" tweeters. • Operating voltage: 12 V. • IP rated: IP67. • Length: 21.31" • Width: 4.04" • Height: 3.85" • Sound Bar Mounting Kit required for installation.

Sound Bar Mount Kit <i>(Not illustrated)</i>	Maverick Trail, Maverick Sport, Maverick Sport MAX	715004745
<ul style="list-style-type: none"> • Required mount kit for the Wet Sounds Stealth 6 Ultra HD Can-Am Edition Sound Bar (715008282). 		

Can-Am SubwooferMaverick Trail, Maverick Sport,
Maverick Sport MAX**715006359**

- Powerful Wet Sounds 8" Subwoofer speakerbox that fits in the glove box.
- Easy plug-and-play connections to Wet Sounds audio system.
- Sturdy construction, tough enough to withstand harsh environments and sealed against moisture and dirt.
- 350 W amplifier and wiring included.

Electronic Device HolderMaverick Trail, Maverick Sport,
Maverick Sport MAX**715005212**

- A great in-ride entertainment system platform.
- Robust injected-polypropylene construction allows for right fit and easy installation.
- Adjustable unit safely holds most tablets and smartphones measuring between 5.1" (13 cm) and 10" (25.4 cm) (with protective case).
- Allows the installation of Garmin Montana 680T GPS.
- Perfectly complements the Wet Sounds audio systems or Rugged Radios Intercom System to play music with your device.
- Integrated storage (2.5 gal (9.5 L) capacity) with access to the dash 12V outlet for device charging.
- Integrated mounting location for RAM mounts.
- Not compatible with Defrost, Heat and Ventilation System (715003678).

ELECTRICAL & ELECTRONIC ACCESSORIES

ELECTRICAL

Defrost, Heat and Ventilation SystemMaverick Trail, Maverick Sport,
Maverick Sport MAX**715003678**

- Best integrated system on the market with 3 ventilation speeds and in-dash adjustable temperature.
- Adjustable/directional vents.
- 5 vents specially positioned for better windshield defrosting and passenger comfort.
- Automotive-style heater core and fan for best heating performance.
- Smart-Lok™ equipped vehicles require Adapter Kit (715007241).
- Not compatible with the ProVent Windshield.

Heated Grab Bar CoverMaverick Trail, Maverick Sport,
Maverick Sport MAX**715004500**

- Made tough to hold up to the stresses of rough riding, this heated cover will keep your passenger's hands warm and securely gripped during long, cold outings.
- Easy to install and remove.
- This kit includes the heated grab bar cover and in-dash switch.
- Heated Accessories Wiring Harness (710005757) is required.
- Draws a maximum of 25 W and 1.8 A at 13.5 W.

Seat HeaterMaverick Trail, Maverick Sport,
Maverick Sport MAX**715006112**

- 25 W seat heater delivers chill-free riding comfort.
- High/low temperature settings allow you to control the desired degree of warmth.
- This kit includes one carbon fiber seat heater, foam sheet and in-dash switch.
- Installs directly in the original seat cushion.
- Heated Accessories Wiring Harness (710005757) is required for front seat installation.
- Heated Accessories Wiring Harness (715006004) is required for rear seat installation.

Heated Visor OutletMaverick Trail, Maverick Sport,
Maverick Sport MAX**715001246**

- Strategically positioned on vehicle to maintain your agility.
- Optional visor outlet that delivers fog-free riding.
- Quick and easy installation.
- Sold individually.
- Heated Visor not included.

Heated Accessories Wiring Harness*(Not illustrated)*Maverick Trail, Maverick Sport,
Maverick Sport MAX**710005757**

- Electric harness required to hook up and operate front heated seats, heated steering wheel and heated grab bar.

Heated Accessories Wiring Harness*(Not illustrated)*

Maverick Sport MAX

715006004

- Electric harness required to hook up and operate rear heated seats.

Heater Adapter Kit for Smart-Lok
(Not illustrated)

Maverick Trail, Maverick Sport,
Maverick Sport MAX

715007241

- Adapter kit to fit heating system on Smart-Lok equipped vehicles.

ELECTRONIC

Cellphone Holder

Maverick Trail, Maverick Sport, Maverick Sport MAX

715008786



- Water resistant door allows for perfect phone positioning.
- Features capacitive and resistive touch screen technology.
- Spring system in back plate automatically adjusts for thickness.
- Fits all cellphones within 7.2" (185 mm) x 3.3" (85 mm) x 0.6" (15 mm) dimensions.
- Works with almost all charger wires.
- Does not include cellphone or charging wires.
- Requires the RAM GPS Mount (715003325) bolted directly on the dashboard for the Cellphone Holder to be supported. RAM GPS Mount (715003325) can also be installed on the Electronic Device Holder (715005212).

RAM[†] GPS Mount

Maverick Trail, Maverick Sport,
Maverick Sport MAX

715003325



- Allows for GPS integration onto vehicle.
- Standard AMPS hole pattern for Garmin Cradle.

Overhead Switch Panel

Maverick Trail, Maverick Sport,
Maverick Sport MAX

715003669



- Fully integrated Overhead Switch Panel gives additional switch spots for electrical accessories.
- Required for Can-Am lights installation on the roof and for other top-mounted electrical accessories.
- Optional for Baja Designs lights.
- Requires Sport Roof or Bimini Roof with Sun Visor for installation.

30 Ah Battery Holder

Maverick Trail, Maverick Sport,
Maverick Sport MAX

715004431



- Fixation plate designed to hold the 30 Ah Battery (515176151).
- 30 Ah battery sold separately.

C-TEK charger

860200997



- CTEK, the manufacturer of the smartest battery chargers in the world, has produced a BRP specific charger for all BRP products.
- Charger is built to meet the demanding arctic conditions.
- Ask your dealer for more information.

Digitally Encoded Security System (D.E.S.S.™) Keys

Maverick Trail 2023 & prior (with 700 engine),
Maverick Trail and Sport (with 1000/1000R engine)

715002458



- Top-security anti-theft protection for your vehicle.
- Encrypted chip technology restricts access to your vehicle's electronic ignition system.
- One vehicle/one code.
- A vibration/shock-resistant ball-and-socket design that ensures a reliable connection.
- 3 programmable modes:
 - Work mode: Limits vehicle speed to 40 kph (25 mph) but does not limit engine torque. Maverick Trail (with 700 engine): Configurable vehicle speed limit between 20 km/h (13 mph) and 100 km/h (60mph) that does not limit engine torque.
 - Normal mode: configurable, limits vehicle speed to 70 km/h (44 mph) and may have torque reduction.
 - Performance mode: No restrictions.

Digitally Encoded Security System (D.E.S.S.) Keys

Maverick Trail 2024 & up (with 700 engine)

715009300



- Top-security anti-theft protection for Can-Am vehicles.
- The encrypted chip technology restricts access to the unit's electronic ignition system.
- One code per vehicle.
- Features a vibration/shock-resistant ball-and-socket design that ensures a reliable connection.
- Comes with three programmable keys, including:
 - Work mode: Configurable vehicle speed limit between 20 km/h (13 mph) and 100 km/h (60mph) that does not limit engine torque.
 - Normal key: Configurable limits vehicle speed to 70 km/h (44 mph) and may have torque reduction
 - Performance key: No restrictions.

WINCHES & HITCHES

CAN-AM HD WINCHES

Can-Am HD 4500 Winch

Maverick Trail, Maverick Sport,
Maverick Sport MAX

715006416



- Ergonomic clutch handle.
- Rugged all-steel gears and bushings for more torque and durability.
- Automatic 100% load-holding brake.
- Sealed solenoid for all-weather protection.
- Weather sealed corded remote and dash mounted switch.
- Pulling strength capability of 4,500 lb (2,041 kg).
- 43' of 1/8" (13.1 m of 6.3 mm) wire steel cable.
- Heavy-duty 4-way roller fairlead.
- Winch Electrical Harness (715003777) is required for installation.
- CE & UKCA Compliant

Can-Am HD 4500-S Winch

Maverick Trail, Maverick Sport,
Maverick Sport MAX

715006417



- Ergonomic clutch handle.
- Rugged all-steel gears and bushings for more torque and durability.
- Automatic 100% load-holding brake.
- Sealed solenoid for all-weather protection.
- Weather sealed corded remote and dash mounted switch.
- Pulling strength capability of 4,500 lb (2,041 kg).
- 50' of 1/4" (15.2 m of 6.35 mm) synthetic rope.
- Corrosion-proof aluminum Hawse fairlead.
- Winch Electrical Harness (715003777) is required for installation.
- CE & UKCA Compliant

WINCH ACCESSORIES

NEW Winch Cable Stopper

All Can-Am HD Winches

715009921



- Made of EPDM, a highly durable synthetic rubber.
- The Winch Cable Stopper isn't just for looks. It helps extend the life of the winch, rope, hook, and fairlead.
- In addition, the split design makes it easy to install.

Can-Am HD Hawse Fairlead

Can-Am HD Winch

715006426



- A must when upgrading your winch with a synthetic cable, this corrosion-proof aluminum Hawse fairlead will prevent the cable from snapping in a corner of a roller fairlead and from wearing prematurely due to the rough surface of the worn roller guide.
- Must be used with synthetic cables only.

Roller Fairlead

Can-Am HD Winch

710007082



- Suggested when changing the wire rope.
- Heavy-duty replacement fairlead for winches.

Synthetic Winch Cable

Can-Am HD Winch
WARN Winch

715006430
715007783



- 50' of 1/4" (15.2 m of 6.35 mm) synthetic cable for Can-Am HD winches.
- Can-Am HD Hawse Fairlead (715006426) is required when upgrading to a synthetic cable to avoid premature cable damage and wear.
- WARN Hawse Fairlead (715007785) is required when upgrading to a synthetic cable to avoid damage and premature wear of the cable.

Wire Rope Replacement

Can-Am HD Winch
WARN Winch

705014978
715006699



- 43' of 1/8" (14.3 m of 6.3 mm) wire rope for Can-Am HD Winch.
- 55' of 1/4" (16.8 m of 6.35 mm) wire rope for WARN winch kit.
- 4,500 lb (2,041 kg) pulling strength.

Synthetic Cable Extension

715001120



- Lightweight 1/4" (6.35 mm) diameter, easy to handle and won't rattle in cargo box.
- Easily attaches to winch cable to provide additional 50' (15.2 m) of distance.
- 4,500 lb (2,041 kg) single line capacity.

NEW Wireless Winch Remote

With Can-Am HD Winch

715008286

- On/Off and Winch In / Winch Out buttons with LED indicator light.
- Large Winch In / Winch Out buttons for easy activation with gloves.
- Ergonomic remote handle shape with a trigger-like holding protrusion.
- Quick and easy to install, thanks to a wiring harness with an integrated antenna and all necessary mounting hardware.
- Allows you to operate your winch from anywhere within a 50' (15.2 m) radius, increasing your recovery options.
- All components are IP67 sealing rated.
- The remote also floats in case it's dropped during a deep water recovery.
- Dash and handlebar mounting options.
- Compatible with all Can-Am HD winches.

Wired Remote Control

Can-Am HD Winch

715006504 (2020 & up)

- This kit allows winch owners to add the hand-held remote to vehicles with a stock winch.
- OEM stock winch and Wired Remote Control are sold separately.
- EC compliant.

HITCHES**Front Receiver Hitch**

Maverick Trail, Maverick Sport, Maverick Sport MAX

715003642

- Heavy-duty 1,500 lb (680 kg) towing capacity 2" (5 cm) receiver hitch.
- Perfect for precision towing in small spaces.

PERFORMANCE**Performance Half Shaft**

Maverick Trail

705402423

Maverick Sport, Maverick Sport MAX

705402281

- High-performance design ideal for off-road use, with superior protection in any riding usage.
- Includes CVs, shaft and boots with the best suited geometry for your Can-Am vehicle.
- Required to install the Smart-Lok Differential Kit.

Mud Smart Mode Module*(Not illustrated)*

Models with Smart-Lok Differential

715005282

- This module allows you to add the Mud Smart Mode to vehicles with the Smart-Lok Differential Kit sold as an accessory or to change to the Mud Smart Mode on vehicles equipped with a standard Smart-Lok.
- The Mud Mode has been specially designed to deliver superior traction in the deepest mud holes.
- When high engine torque and/or slippage is detected, Smart-Lok will fully lock the front end.
- The system will stay locked until throttle release.
- Only one Smart Mode Module can be installed at a time.

Rock Smart Mode Module*(Not illustrated)*

Models with Smart-Lok Differential

715005283

- This module allows you to add the Rock Smart Mode to vehicles with the Smart-Lok Differential Kit sold as an accessory or to change to the Rock Smart Mode on vehicles equipped with a standard Smart-Lok.
- The Rock Mode has been specially designed to help cross challenging rocks.
- When high engine torque is detected at low vehicle speed, Smart-Lok will progressively lock the front end and will stay engaged until throttle release to prevent wheel slippage and provide optimal traction.
- The progressive engagement allows for easier steering when maneuvering the vehicle.
- Only one Smart Mode Module can be installed at a time.

Trail Activ Smart Mode Module*(Not illustrated)*

Models with Smart-Lok Differential

715005284

- This module allows you to add the Trail Activ Smart Mode to vehicles with the Smart-Lok Differential Kit sold as an accessory or to change to the Trail Activ Smart Mode on vehicles equipped with a standard Smart-Lok.
- The Trail Activ Mode has been designed for aggressive riding, delivering the ultimate cornering precision.
- When high engine torque and/or an increase in vehicle speed is detected, Smart-Lok will progressively engage the front end and keep it engaged until throttle release or vehicle speed reduction.
- The progressive engagement allows for smoother and lower steering effort.
- Only one Smart Mode Module can be installed at a time.

EXHAUST AND AIR INTAKE

Yoshimura[†] Slip-On Exhaust

Maverick Sport, Maverick Sport MAX
(models with 1000R engine)

715004452



- Developed in collaboration with Yoshimura.
- Made from 304-grade stainless steel.
- Sporty sound from a lighter-than-stock muffler.

- USDF/USDA approved spark arrester.
- EPA compliant.
- Not CE Compliant.

Installation of some accessories shown may impact vehicle compliance with some regulations. Consult your local dealer for information.

Performance Air Filter by Twin AIR[†]

Maverick Trail, Maverick Sport, Maverick Sport MAX
(models with 1000R engine)

715002895

Maverick Trail, Maverick Sport
(except models with 1000R engine)

715003630



- The best choice for the harshest conditions.
- Multiple staged oiled filtering foam for superior dust retaining capacity with high airflow.
- Washable and reusable.

Engine and CVT Pre-Filter Kit

(Not illustrated)

Maverick Trail, Maverick Sport,
Maverick Sport MAX

715004290

- Adds extra protection to your engine and CVT in harsh riding conditions.
- Filter blocks particles larger than 0.005" (0.1 mm).
- Water repellent screen.
- Mandatory to maintain the vehicle's warranty when tracks are installed.

- Recommended for winter riding conditions.
- Not compatible with Snorkel Kit.
- Not compatible with Adventure Roof Rack.

Snorkel Pre-Filter

Maverick Trail, Maverick Sport,
Maverick Sport MAX

715005598



- Pre-filter specifically for snorkels.
- Adds extra protection to your engine in harsh riding conditions.
- Helps keep air filter cleaner.
- Filter blocks particles larger than 0.005" (0.13 mm).
- Mandatory to maintain vehicle warranty when tracks are installed.

Snorkel Kit

Maverick Trail (except 700 engines),
Maverick Sport, Maverick Sport MAX

715003705



- Raises point of engine and CVT air intakes so vehicle can be semi-submersed in water/mud without taking in water to the engine.
- Not compatible with S&B Particle Separator, LinQ Pivoting Rack, Lonestar Racing Rear Intrusion Bar and all rear panels and windows.

- Standard on Maverick Sport models.

Installation of some accessories shown may impact vehicle compliance with some regulations. Consult your local dealer for information.

Heavy-Duty Spring Kit

Maverick Trail

715004961



- This set of heavy-duty springs will stiffen your suspension.
- Perfect for reducing vehicle overall sag when shocks are under heavy demand: heavy loading and hauling or for snow clearing.
- Complete kit of 4 springs.

Shock Covers

(Not illustrated)

Maverick Sport, Maverick Sport MAX

715002368

- Soft covers for shocks with ventilation holes.
- Eliminate dust and dirt intrusion into the shock cylinder, reducing risk of damage.
- Sold in pairs.

EMERGENCY ACCESSORIES

Emergency Kit

Maverick Trail, Maverick Sport,
Maverick Sport MAX

715006102



- Complete emergency kit provides all essential equipment and supplies to get out of most unfavorable situations powersport enthusiasts can find themselves in.
- Includes: Jumper Cables, Air Compressor, Tire Repair Kit, Ratchet Tie-Down, Duct Tape, Tow Strap 3,300 lb (1,500 kg), Zip Ties, Cloth Rags.

No traction? No problem. Apache XC LT Tracks are built for serious terrain. With improved flotation and stability, they tackle deep snow, mud, and everything in between. Engineered for optimized attack angles, reduced noise, and unmatched durability, this system means all-season dominance.

DESIGNED FOR PEAK PERFORMANCE

Aggressive lugs deliver max traction without sacrificing handling. A reinforced steel frame boosts strength, while the center slide improves alignment and reduces de-tracking. Reduced NVH levels and the wheel placement ensure smooth, quiet power delivery. Plus, wheel longevity is increased with replaceable wheel bearings.



APACHE TRACK SYSTEMS

YEAR-ROUND TRACKS LIMITED WARRANTY*

Apache XC LT Track System	Maverick Trail, Maverick Sport, Maverick Sport MAX	715007719
	<ul style="list-style-type: none"> • Long Track version. • Brand-new track design to optimize driving off and in deep snow conditions. • Reduction in steering effort thanks to the tandem 4 wheels. • Vibrations are reduced due to the alignment of the wheels with the rolling band of the track and the shaft damper mounted tandem. • Better steering precision because of this wheel and track alignment due to good ground contact. • 1.25" (3.175 cm) lugs in the front and in the back for better traction and lateral stability. • Track width: front 12.5" and rear 15". • Adds 3" (7.62 cm) of ground clearance versus 27" tires. 	<ul style="list-style-type: none"> • Additional shaft dampers, tandem dampers, track design and wheel layout significantly reduce NVH (noise vibration harshness). • Central guide for optimized track alignment and reduced occurrences of detracking. • Optimized track layout with increased angle of attack for better obstacle crossing and snow performance. • Stamped and welded steel frame for improved strength and durability. • Easy maintenance with replaceable hub and wheel bearings. • Main hub is oil bath with 3 bearings inside for consistent lubrication. • DPS module and engine and CVT pre-filter required. • Mounting kit sold separately.
<p><i>Installation of some accessories shown may impact vehicle compliance with some regulations. Consult your local dealer for information.</i></p>		

Apache XC LT Mounting Kit <i>(Not illustrated)</i>	See table for fit, compatibility and requirements.	715008611 715008612 715008613
<ul style="list-style-type: none"> • Required for installation of the Apache XC LT Track System. • Track DPS Module and Pre-Filter not included. <p><i>Installation of some accessories shown may impact vehicle compliance with some regulations. Consult your local dealer for information.</i></p>		

*The limited warranty is subject to the exclusions, limitations of liabilities and all other terms and conditions of BRP's standard limited warranty.

Apache Backcountry Track System	See table for specific models	715005247
	<ul style="list-style-type: none"> Designed to deliver the best flotation level and deep-snow performance on the market. Contact patch is 23% bigger than the Apache 360 LT. Provides an impressive average ground clearance increase of 7" (18 cm), keeps the vehicle out of deep snow. 	<ul style="list-style-type: none"> Aggressive track design with 2" (5 cm) lug height for maximum traction on snow. Apache Backcountry Mounting Kit, Track DPS Module and Engine and CVT Pre-Filter are required. For winter use only. Track installation will affect vehicle width and length.
<i>Installation of some accessories shown may impact vehicle compliance with some regulations. Consult your local dealer for information.</i>		

Apache Backcountry LT Track System	See table for specific models	715005891
	<ul style="list-style-type: none"> Tracks designed to deliver the best snow performance on the market with unmatched flotation level and traction on snow surface. Large contact patch, 37% bigger than the Apache 360 LT. Impressive added ground clearance of 7" (18 cm) helps keep the vehicle over the snow. Lightweight snowmobile-inspired rail design. Aggressive track design with 2" (5 cm) lug height for maximum traction on snow. 	<ul style="list-style-type: none"> Apache Backcountry LT Mounting Kit, Track DPS Module, Engine and CVT Pre-Filter are required. Fine-tune your track system using extra Idler Wheels, Sliders with Vespel Inserts and Rail Ice Scratcher. For winter use only. Track installation will affect vehicle width and length.
<i>Installation of some accessories shown may impact vehicle compliance with some regulations. Consult your local dealer for information.</i>		

Apache Backcountry Mounting Kit <i>(Not illustrated)</i>	See table for specific models Maverick Trail	715004834 715004285
<ul style="list-style-type: none"> Required for installation of the Apache Backcountry Track System. Not compatible with HMWPE Front and Rear A-Arm Protectors and Skid Plates. DPS Module and Pre-Filter not included. 		
<i>Installation of some accessories shown may impact vehicle compliance with some regulations. Consult your local dealer for information.</i>		

Apache Backcountry LT Mounting Kit <i>(Not illustrated)</i>	See table for specific models	715005493
<ul style="list-style-type: none"> Required for installation of the Apache Backcountry Track LT System. DPS Module and Pre-Filter are required and sold separately. Not compatible with HMWPE Front and Rear A-Arm Protectors and Skid Plates. 		
<i>Installation of some accessories shown may impact vehicle compliance with some regulations. Consult your local dealer for information.</i>		

ACCESSORIES

Track DPS Module <i>(Not illustrated)</i>	Maverick Trail 2024 & up Maverick Trail, Maverick Sport	715006266 715007338
<ul style="list-style-type: none"> Innovative DPS module that ensures speedometer accuracy and optimized steering assist which make for perfect track control and riding ease. Required to install the Apache and Backcountry Track Systems. 		
<i>Installation of some accessories shown may impact vehicle compliance with some regulations. Consult your local dealer for information.</i>		

Rail Ice Scratchers	Apache Backcountry and Apache Backcountry LT Track Systems	860201728
	<ul style="list-style-type: none"> Provide additional lubrication in hard and icy conditions. Rail mounted, small, light. Design expands on coil concept to allow reversing without damage. Easily stored when not in use. Extend slider life. 	

Idler Wheel Kit	Apache Backcountry Track System, rear tracks only	860201230 141 mm
	<ul style="list-style-type: none"> Reduces drag and rolling resistance. Includes 2 wheels, brackets and hardware. Add up to 2 kits per rear track. Can extend slider life in hardened snow conditions. 	

*The limited warranty is subject to the exclusions, limitations of liabilities and all other terms and conditions of BRP's standard limited warranty.

Sliders with Vespel[®] Inserts

Apache Backcountry and Apache Backcountry LT Track Systems

503194815



- Use DuPont Vespel inserts for less friction.
- Longer life.
- Can be cut to desired length.
- 8 needed per vehicle.
- Sold individually.

Apache Backcountry LT Wheel Kit

Apache Backcountry and Apache Backcountry LT Track Systems

715006293



- Additional wheel kit for Backcountry LT rear tracks.
- Reduces drag and rolling resistance in hard snow conditions or when transporting heavier loads.
- Extends slider life in hard snow conditions.
- Includes two wheels, cross shaft and mounting hardware per kit to service one track corner.
- Up to two kits per rear track can be installed.

APACHE TRACK SYSTEMS FITTING GUIDE

APACHE BACKCOUNTRY AND BACKCOUNTRY LT

Model Year / Model		Track	Track Mount	Track DPS Module	Prefilter without Snorkel	Prefilter with Snorkel
2018 & Up	Maverick Trail, Maverick Trail DPS 1000	715005247	715004285	715007338	715004290	715005598
2018 to 2023	Maverick Trail: Base, DPS 700					
2019 & Up	Maverick Sport, Maverick Sport MAX		715004834			
2021* & Up	Maverick Sport		715005891	715005493		
2024 & Up	Maverick Trail: Base, DPS 700		715005247	715004285		

*For 2021 models produced after January 18, 2021.

APACHE XC LT

Model Year / Model		Track	Track Mount	Track DPS Module	Prefilter without Snorkel	Prefilter with Snorkel
2018 to 2023	Maverick Trail	715007719	715008611	715007338	715004290	715005598
2019 & Up	Maverick Sport, Maverick Sport MAX		715008613			
2021* & Up	Maverick Sport		715008612			
2024 & Up	Maverick Trail		715008611	715006266		

*For 2021 models produced after January 18, 2021.

BUILD A KIT THAT WORKS HARD.

Combine a mounting kit, push frame, and blade. Then, customize with accessories like the plow angling kit, blade extensions, or edge markers. Easy to install, engineered to last, and tough enough for brutal winter jobs—this lineup covers every plowing need.



PROMOUNT PLOWS

PROMOUNT PLOW KITS

REFERENCE CHART

	66" Black Steel	72" Black Steel	66" Flex2	72" Flex2
Plow Kit	715007775	715007777	715007774	715007776
Blade	715009881	715009877	715009883	715009868
Push Frame	715004980	715004980	715004980	715004980
Mounting Plate	715007742	715007742	715007742	715007742

CAN-AM ProMount STEEL PLOW KITS

Can-Am ProMount Steel 66" (168 cm) Plow Kit	Maverick Trail, Maverick Sport, Maverick Sport MAX	■ 715007755
Can-Am ProMount Steel 72" (183 cm) Plow Kit	Maverick Trail, Maverick Sport, Maverick Sport MAX	■ 715007777



- These kits include:
 - Can-Am ProMount Steel Blade
 - Push Frame with Quick-Attach System
 - Can-Am ProMount Mounting Plate

CAN-AM ProMount STEEL BLADES

Can-Am ProMount Steel 66" (168 cm) Blade	Fits ProMount Push Frame	■ 715009881
---	--------------------------	--------------------



- Plow blade made from 12-gauge steel.
- Replaceable wear blade.
- Large pin designed for easy blade rotation to eliminate snow buildup at pivot point.
- Blade design provides best snow roll-off at any angle.

- Clears 60" (152 cm) when plow is fully angled.
- Blade height of 17" (43 cm).
- Compatible with Can-Am ProMount Blade accessories to further enhance plow versatility.
- Not compatible with S3 High Clearance Front A-Arm.

Can-Am ProMount Steel 72" (183 cm) Blade	Fits ProMount Push Frame	■ 715009877
---	--------------------------	--------------------



- Plow blade made from 12-gauge steel.
- Replaceable wear blade.
- Large pin designed for easy blade rotation to eliminate snow buildup at pivot point.
- Blade design provides best snow roll-off at any angle.

- Clears 66" (168 cm) when plow is fully angled.
- Blade height of 17" (43 cm).
- Compatible with Can-Am ProMount Blade accessories to further enhance plow versatility.
- Not compatible with S3 High Clearance Front A-Arm.

CAN-AM ProMount ANGLE PLOWS

Can-Am ProMount 66" (168 cm) Steel Oneway State Blade	Fits ProMount Push Frame	715007263
--	--------------------------	------------------

Can-Am ProMount 72" (183 cm) Steel Oneway State Blade	Fits ProMount Push Frame	715009879
--	--------------------------	------------------



- Make the job easier with the right tools, clear long alleys and make the task easier by sending the snow further out of the way.
- Wing end of plow measures 26" (67 cm) high and tapers down to 16" (41 cm).
- One-way "winged" state plow designed to throw snow higher.
- Rubber Flap (715007299) designed to keep snow away from the driver is offered as accessory (sold separately).
- Can-Am branded.

CAN-AM ProMount FLEX2 PLOW KIT

Can-Am ProMount Flex2 66" (168 cm) Plow Kit	Maverick Trail, Maverick Sport, Maverick Sport MAX	715007774
--	--	------------------

Can-Am ProMount Flex2 72" (183 cm) Plow Kit	Maverick Trail, Maverick Sport, Maverick Sport MAX	715007776
--	--	------------------



- These kits include:
 - Can-Am ProMount Flex2 Blade
 - Push Frame with Quick-Attach System
 - Can-Am ProMount Mounting Plate

CAN-AM ProMount FLEX2 BLADES

Can-Am ProMount Flex2 66" (168 cm) Blade	Fits ProMount Push Frame	715009883
---	--------------------------	------------------



- Plow blade made of UHMWPE, a flexible and impact absorbing material that prevents damaging your plow when accidental impact occurs.
- Replaceable wear blade.
- Large pin designed for easy blade rotation to eliminate snow buildup at pivot point.
- Blade design provides best snow roll-off at any angle.
- Clears 60" (152 cm) when plow is fully angled.
- Blade height of 17" (43 cm).
- Compatible with Can-Am ProMount Blade accessories to further enhance plow versatility.

Can-Am ProMount Flex2 72" (183 cm) Blade	Fits ProMount Push Frame	715009868
---	--------------------------	------------------



- Plow blade made of UHMWPE, a flexible and impact absorbing material that prevents damaging your plow when accidental impact occurs.
- Replaceable wear blade.
- Large pin designed for easy blade rotation to eliminate snow buildup at pivot point.
- Blade design provides best snow roll-off at any angle.
- Clears 66" (168 cm) when plow is fully angled.
- Blade height of 17" (43 cm).
- Compatible with Can-Am ProMount Blade accessories to further enhance plow versatility.

CAN-AM ProMount PLOW ACCESSORIES

Can-Am ProMount Edge Markers	Fits ProMount Plow Blades	715004206
-------------------------------------	---------------------------	------------------



- Help locate the edges of your plow.
- Height: 24" (60 cm).
- Sold in pairs.
- Recommended for Maverick Trail and Maverick Sport.
- Compatible with Can-Am ProMount Steel and Flex2 blades with or without Blade Extensions (except for the Can-Am ProMount Steel 54" (137 cm) Blades).

Can-Am ProMount 66" (168 cm) Plastic Wear Blade	Fits ProMount Plow Blades	715004482
--	---------------------------	------------------

Can-Am ProMount 72" (183 cm) Plastic Wear Blade	Fits ProMount Plow Blades	715004483
--	---------------------------	------------------



- Ideal to prevent leaving marks on your driveway.
- Compatible with Can-Am ProMount 72" (183 cm) Blades.

Can-Am ProMount Drift Cutters	Fits ProMount Plow Blades	715006258
--------------------------------------	---------------------------	------------------



- Help keep snow in the plow.
- Dimensions: 17" x 13" (43.2 cm x 33 cm).
- Sold in pairs.
- Compatible with Can-Am ProMount Steel and Flex2 blades with or without Blade Extensions (except for the Can-Am ProMount Steel 54" (137 cm) Blades).

Can-Am ProMount Blade Extensions	Fits ProMount Plow Blades	715004205
---	---------------------------	------------------



- These conveniently extend your Can-Am ProMount Blade.
- Add 3" (8 cm) to each side.
- Compatible with Can-Am ProMount Blades (except for the Can-Am ProMount Steel 54" (137 cm) Blades).
- Longer wear blade can be installed to go over the extra length given by the extensions.

Back Drag Blade <i>(Not illustrated)</i>	Fits ProMount Plows (60" and more)	715007794
--	------------------------------------	------------------

- ¼-in. thick steel swivel scraper.
- Lifts up when the vehicle is moving forward so as to not affect the scraping.
- Increased capacity to pull snow.
- More aggressive scraping in reverse mode.
- Lifts the scraper off the ground so that it scrapes evenly.
- Adjustable in length for compatibility with 60", 66" and 72" blades.
- Compatible with ProMount blades (Flex and Steel).

Curved Wear Blade <i>(Not illustrated)</i>	Fits ProMount Plow Blades	715007792 · 66" (168 cm) 715007793 · 72" (183 cm)
--	---------------------------	--

- Wear blade designed with a folded back bottom lip.
- The increased surface allows for less digging while plowing uneven surfaces.
- Ideal for snow covered gravel, grass, paver stone and other soft surfaces.

CAN-AM ProMount CUSTOM SOLUTIONS

Can-Am ProMount Push Frame with Quick-Attach System	Maverick Trail, Maverick Sport, Maverick Sport MAX	715004980
--	--	------------------



- Heavy-duty steel tubes designed to withstand the roughest use.
- Mid-mount carriage provides ultimate push strength and traction.
- Allows 16" (41 cm) of plow lift on ATVs and 14" (36 cm) on Maverick Trail.
- Features a self aligning quick-attach system, an easy foot release pedal and an ergonomic handle for plow angle adjustment.

Can-Am ProMount Push Frame Extension	Maverick Trail, Maverick Sport, Maverick Sport MAX	715006257
---	--	------------------



- 12" (30 cm) push frame extension required when plow is installed with Apache Track systems.

Plow Roller Fairlead	Maverick Trail, Maverick Sport, Maverick Sport MAX	715001223 • Cylindrical Roller Fairlead
-----------------------------	--	---



- Larger diameter lower roller reduces wear on wire rope for plow application.
- Can be used with all ProMount plows.

Can-Am ProMount Plow Angling System	Maverick Trail, Maverick Sport, Maverick Sport MAX	715009657
--	--	------------------



- Converts your plow system into a unit that's easy to control from the driver's seat.
- Using one hand to control all plow motions will allow you to easily concentrate and manage your plowing tasks.
- Not compatible with Apache Backcountry LT Track System.
- Can-Am ProMount Push Frame (715010845) is required.
- Winch and plow sold separately.

NEW Plow Quick Adjust Blade Shoes	ProMount Steel & Flex2 Blades 60" (all years), 66" & 72" (2025 & prior)	715009751
--	---	------------------



- Zinc-plated steel construction for corrosion resistance.
- Easy and quick tool-free adjustment.
- Pre-set adjustment for different heights.
- Larger shoe diameter for greater ground contact.
- Improved shoe design for better flotation.

ProMount Plow Limit Switch	Maverick Trail, Maverick Sport, Maverick Sport MAX	715006259
-----------------------------------	--	------------------



- For controlling the cable tension when over-raising your plow system.
- Prevents winch, plow push frame and vehicle damage.
- Sensor relocated for optimal lift height.

Can-Am ProMount Mounting Plate	Maverick Trail, Maverick Sport, Maverick Sport MAX	715007742
---------------------------------------	--	------------------



- Required to install the Can-Am ProMount Push Frame with Quick-Attach System.
- Mounting plate precision-designed to stay on year round without compromising ground clearance.
- Plow roller fairlead included.

COVERS

Trailer Cover	Maverick Trail, Maverick Sport	715003706
----------------------	--------------------------------	------------------



- Weather-resistant trawling cover protects your vehicle during storage and transportation.
- Heavy-duty canvas made of UV-resistant solution-dyed polyester.
- Inner soft liner protects windshield.
- All high-abrasion areas are reinforced with a double canvas layer.
- Opening for fuel cap.
- Quick and easy installation.
- Designed to perfectly fit your vehicle with or without Can-Am accessories except with Adventure Roof Rack and track kits.

PARTS AND MAINTENANCE



PARTS AND MAINTENANCE

Keep an Eye on These Parts	196
Air Filters	201
Oil Filters	201
Spark Plugs	202
Batteries	202
Axles	204
Ball Joint	206
Brake Pads	207
Belts	209
pDrive Maintenance Kits	209
QRS Rollers	209
XPS Tires	212
Lubricant & Oil Change Kit	214
Maintenance Products	215





BLENDING PERFORMANCE AND SAFETY

TRUST GENUINE CAN-AM PARTS
TO KEEP YOUR VEHICLE PERFORMING
AT ITS BEST.

TWO-YEAR WARRANTY*

- ✓ Precisely engineered.
- ✓ Rigorously tested.
- ✓ Factory approved.

*Covers parts and labor when fitted at an authorized dealer.

CAN-AM TRAXTER G1



To make sure your Traxter G1 performs as you expect, **keep an eye on these components.****

OIL FILTER 420256188

ENGINE OIL*

4T 10W-50 Synthetic Oil	1 quart / 946 ml	9779234
	1 US gallon / 3.785 L	9779235
4T 0W-40 Synthetic Oil	1 quart / 946 ml	9779139
	1 US gallon / 3.785 L	9779140
5W-40 Synthetic Oil	1 quart / 946 ml	9779492
	1 US gallon / 3.785 L	9779493

OIL CHANGE KIT*

5W-40 Synthetic Oil	500 cc or more V-twin engine	9779488
5W-40 Synthetic Oil	ACE 650 cc single cylinder	9779480
0W-40 Synthetic Oil	500 cc or more V-twin engine	9779259
0W-40 Synthetic Oil	ACE 650 cc single cylinder	9779481
10W-50 Synthetic Oil	500 cc or more V-twin engine	9779252
5W-40 Synthetic Oil	450 cc or less	9779487
0W-40 Synthetic Oil	450 cc or less	9779257

TRANSMISSION OIL*

Front Differential	32 oz / 0.946 L	9779158
75W-90 Gear Oil, Synthetic		
Gearbox	32 oz / 0.946 L	9779160
75W-140 Gear Oil, Synthetic		

EMISSION CONTROL

Fuel Tank Vent Breather Filter	Non-EVAP models	709001120
Canister Vent Pre-filter	CARB and EVAP models	709000524
Canister Fuel Filter	CARB and EVAP models	513034047

AIR FILTER 715900394

CVT AIR FILTER

HD9, HD10	706600419
-----------	-----------

DRIVE BELT

HD10	Premium (Stock)	422280652
HD9	Premium (Stock)	422280656
HD7	Premium (Stock)	422280225
Performance (Upgrade)	See Reference Chart for upgrade	

CLUTCH MAINTENANCE KITS

pDrive Ramp Rollers	Maintenance Kit	420629237
pDrive Torque Rollers	Maintenance Kit	420629224
QRS XD Roller Kit	Pack of 3	861805583

BRAKE PAD KITS

Front Brake Pads (4 pads + hardware)	Traxter (All models)	703501198
Rear Brake Pads (4 pads + hardware)	Traxter HD7-HD9-HD10	703501200
	Traxter MAX-PRO-6X6	703501199

CV BOOT KITS

Front Wheel Side	705401345
Front Differential Side	705401355
Rear	705501864

WHEEL BEARINGS 293350150

FRONT A-ARM BUSHING KIT 703500875

BALL JOINTS

Lower	703501262
Upper	703501263

SPARK PLUG

HD10	715900244
HD9	715901051
HD7	715900785

BATTERY

18 aH Yuasa YTX20L fact. activated	410301203
30 aH Yuasa YIX30L fact. activated	515176151

* For Europe, please check the correspondent PNs on page 215.

**Refer to periodic maintenance chart for proper intervals.

CAN-AM TRAXTER G2



To make sure your Traxter G2 performs as you expect, **keep an eye on these components.****

OIL FILTER 420956123

ENGINE OIL*

4T 10W-50 Synthetic Oil	1 quart / 946 ml	9779234
	1 US gallon / 3.785 L	9779235
4T 0W-40 Synthetic Oil	1 quart / 946 ml	9779139
	1 US gallon / 3.785 L	9779140
5W-40 Synthetic Oil	1 quart / 946 ml	9779492
	1 US gallon / 3.785 L	9779493

OIL CHANGE KIT*

5W-40 Synthetic Oil	Rotax 900/999 ACE	9779502
10W-50 Synthetic Oil	Rotax 900/999 ACE	9779503
0W-40 Synthetic Oil	Rotax 900/999 ACE	9779504

TRANSMISSION OIL*

Front Differential	32 oz / 0.946 L	9779158
75W-90 Gear Oil, Synthetic		
Gearbox	32 oz / 0.946 L	9779160
75W-140 Gear Oil, Synthetic		

EMISSION CONTROL

Fuel Tank Vent Breather Filter	Non-EVAP models	709001120
Canister Vent Pre-filter	CARB and EVAP models	709000524
Canister Fuel Filter	CARB and EVAP models	513034047

AIR FILTER 715900422

CVT AIR FILTER 706600423

DRIVE BELT

HD11	Premium (Stock)	422280652
-------------	-----------------	-----------

CLUTCH MAINTENANCE KITS

pDrive Ramp Rollers	Maintenance Kit	420629237
pDrive Torque Rollers	Maintenance Kit	420629224
QRS XD Roller Kit	Pack of 3	861805583

BRAKE PAD KITS

Front Brake Pads (4 pads + hardware)	Traxter (all models)	703501260
Rear Brake Pads (4 pads + hardware)	Traxter MAX (all)	703501260
	Traxter non-MAX (all)	703501261

CV BOOT KITS

Front Wheel Side	715901034
Front Differential Side	715901035
Rear Wheel Side	715901064
Rear Differential Side	715901063

WHEEL BEARINGS 293350151

BALL JOINTS

Lower	703501262
Upper	703501263

SPARK PLUG

HD11	715900785
-------------	-----------

BATTERY

30 aH Yuasa YIX30L fact. activated	515176151
------------------------------------	-----------

* For Europe, please check the correspondent PNs on page 215.

**Refer to periodic maintenance chart for proper intervals.

CAN-AM MAVERICK R



To make sure your Maverick R performs as you expect,
keep an eye on these components.**

OIL FILTER 420956747

ENGINE OIL*

4T 10W-50 Synthetic Oil	1 quart / 946 ml	9779234
	1 US gallon / 3.785 L	9779235
4T 0W-40 Synthetic Oil	1 quart / 946 ml	9779139
	1 US gallon / 3.785 L	9779140
4T 5W-40 Full Synthetic Oil	1 quart / 946 ml	9779492
	1 US gallon / 3.785 L	9779493

OIL CHANGE KIT*

5W-40 Oil Change Kit	Rotax 999T	9779500
10W-50 Oil Change Kit	Rotax 999T	9779501

TRANSMISSION OIL*

Oil Change Kit	Can-Am DCT Transmission	9779725
Differential Oil	32 oz / 0.946 L	9779158
75W-90 Gear Oil, Synthetic		
DCT Gearbox Oil	DCT Fluid 32 oz / 0.946 L	9779710
XPS Synthetic		

EMISSION CONTROL

Fuel Tank Vent Breather Filter	Non EVAP models	709001120
Canister Vent Pre-filter	CARB and EVAP models	709000524
Canister Fuel Filter	CARB and EVAP models	513034047

AIR FILTER

Performance Air Filter by Twin Air†		715002895
Premium Air Filter		715900422

BRAKE PAD KITS

Front Brake Pads	4 pads + hardware	703501223
Rear Brake Pads	4 pads + hardware	703501226

CV BOOT KITS

Rear wheel side, NT1 transmission	Base, X and X rs	715500543
Rear diff side, NT1 transmission	Base, X and X rs	715500542
Rear (wheel side), NT2 transmission	MAX & X rc models	715900929
Rear (diff. side), NT2 transmission	MAX & X rc models	715500551
Front (wheel & diff. side)		715900450

WHEEL HUBS (with integrated bearings)

Front		705402652
Rear		705503036

BALL JOINTS

Lower		703501263
Upper		703501262

SPARK PLUG

		715900935
--	--	-----------

BATTERY

18 aH Yuasa YTX20L fact. activated	X & X rs	410301203
30 aH Yuasa YIX30L fact. activated	X rc	515176151

* For Europe, please check the correspondent PNs on page 215.

**Refer to periodic maintenance chart for proper intervals.

CAN-AM MAVERICK



To make sure your Maverick performs as you expect,
keep an eye on these components.**

OIL FILTER 420956123

ENGINE OIL*

4T 10W-50 Synthetic Oil	1 quart / 946 ml	9779234
	1 US gallon / 3.785 L	9779235

4T 0W-40 Synthetic Oil	1 quart / 946 ml	9779139
	1 US gallon / 3.785 L	9779140

4T 5W-40 Full Synthetic Oil	1 quart / 946 ml	9779492
	1 US gallon / 3.785 L	9779493

OIL CHANGE KIT*

5W-40 Full Synthetic	900 ACE	9779489
10W-50 Synthetic Oil	900 ACE	9779261

TRANSMISSION OIL*

Front Differential	32 oz / 0.946 L	9779158
75W-90 Gear Oil, Synthetic		

Gearbox	32 oz / 0.946 L	9779160
75W-140 Gear Oil, Synthetic		

EMISSION CONTROL

Fuel Tank Vent Breather Filter	Non EVAP models	709001120
Canister Vent Pre-filter	CARB and EVAP models	709000524
Canister Fuel Filter	CARB and EVAP models	513034047

AIR FILTER

Performance Air Filter by Twin Air†	715002895
Premium Air Filter	715900422

CVT AIR FILTER	706600416
-----------------------	-----------

DRIVE BELT 422280652

CLUTCH MAINTENANCE KITS

pDrive Ramp Rollers	Maintenance Kit	420629237
pDrive Torque Rollers	Maintenance Kit	420629224
QRS XD Roller Kit	Pack of 3	861805583

BRAKE PAD KITS

Front Brake Pads	4 pads + hardware	703501198
Rear Brake Pads	4 pads + hardware	703501199

CV BOOT KITS

Rear Wheel & Differential Side	715900450
Front Wheel & Differential Side	705401354

WHEEL BEARINGS	293350151
-----------------------	-----------

BALL JOINTS

Lower	703501262
Upper	703501263

SPARK PLUG

Maverick	Except 900HO	415130363
Maverick	900HO	415130795

BATTERY

18 aH Yuasa YTX20L fact. activated	410301203
------------------------------------	-----------

* For Europe, please check the correspondent PNs on page 215.

**Refer to periodic maintenance chart for proper intervals.

CAN-AM MAVERICK SPORT, MAVERICK TRAIL



To make sure your Maverick Sport or Trail performs as you expect,
keep an eye on these components.**

OIL FILTER 420256188

ENGINE OIL*

4T 10W-50 Synthetic Oil	1 quart / 946 ml	9779234
	1 US gallon / 3.785 L	9779235
4T 0W-40 Synthetic Oil	1 quart / 946 ml	9779139
	1 US gallon / 3.785 L	9779140
4T 5W-40 Full Synthetic Oil	1 quart / 946 ml	9779492
	1 US gallon / 3.785 L	9779493

OIL CHANGE KIT*

500 cc or more V-twin engine

0W-40 Synthetic Oil	9779259
5W-40 Full Synthetic	9779488
10W-50 Synthetic Oil	9779252

ACE 650 cc Single Cylinder

0W-40 Full Synthetic	9779481
5W-40 Full Synthetic	9779480

TRANSMISSION OIL*

Front Differential	32 oz / 0.946 L	9779158
75W-90 Gear Oil, Synthetic		
Gearbox	32 oz / 0.946 L	9779160
75W-140 Gear Oil, Synthetic		

EMISSION CONTROL

Fuel Tank Vent Breather Filter	Non EVAP models	709001120
Canister Vent Pre-filter	CARB and EVAP models	709000524
Canister Fuel Filter	CARB and EVAP models	513034047

AIR FILTER

Performance Air Filter by Twin Air†		715002895
Maverick Trail & Sport	700 cc & 1000 cc	715900394
Maverick Trail & Sport	1000R	715900422

CVT AIR FILTER

Except X mr	706600417
-------------	-----------

DRIVE BELT

Maverick Trail	700	422280225
Maverick Trail / Sport	1000	422280656
Performance (upgrade)	See Reference Chart for upgrade	

CLUTCH MAINTENANCE KITS

Maverick Trail 700

pDrive Ramp Rollers	Maintenance Kit	420629237
pDrive Torque Rollers	Maintenance Kit	420629224

Maverick Sport 1000R

QRS XD Roller Kit	Pack of 3	861805583
-------------------	-----------	-----------

BRAKE PAD KITS

Front Brake Pads	4 pads + hardware	703501198
Rear Brake Pads	4 pads + hardware	703501199

CV BOOT KITS

Maverick Sport , (ABS, X xc, X mr, X rc models only)	
Front Wheel Side	705401354

Maverick Sport (no ABS, Base and DPS models only), **Maverick Trail** (all models)

Front Wheel Side	705401345
Front Differential Side	705401355
Rear	705501864

WHEEL BEARINGS

	293350150
--	-----------

A-ARM BUSHING KIT

	703500875
--	-----------

BALL JOINTS

Lower	703501262
Upper	703501263

SPARK PLUG

Maverick Trail	700	715900785
Maverick Trail & Sport	1000	715901051
Maverick Trail & Sport	1000R	715900244

BATTERY

18 aH Yuasa YTX20L fact. activated	410301203
------------------------------------	-----------

** For Europe, please check the correspondent PNs on page 215.
*Refer to periodic maintenance chart for proper intervals.

Can-Am air filters are built for harsh conditions, delivering superior filtration without choking performance. Made to meet exact specs and protect engines from dust, mud, and debris, they're the first line of defense when the ride gets rough.

BUILT STRONG. FILTERS SMARTER.

Each filter features high-density pleated media for maximum dirt-holding capacity, a molded seal for tight fit, and durable construction to prevent collapse in extreme conditions. Engineered to work in sync with Can-Am engines—no guesswork, no compromise.



AIR FILTERS

Premium Air Filter	Models	
	Traxter G1, all packages incl. MAX, 2016–2026 Maverick Sport & Trail except 1000R engine, 2018–2026	715900394
	Maverick, all packages incl. MAX, 2017–2026 Maverick R (incl. MAX), 2024–2026 Maverick Sport & Trail (incl. MAX), 1000R engine only, 2019–2026 Traxter G2, all packages, 2026	715900422
	Maverick G1 except 1000T engine, 2013–2018	707800327
	Maverick G1, 1000T engine only, 2015–2017	715900356

OIL FILTERS

Engine Oil Filter	Models	
	Traxter G1, Maverick Trail, Maverick Sport	420256188
	Maverick, Traxter G2 HD11	420956123
	Maverick R	420956747
Transmission Oil Filter <i>(Not illustrated)</i>	Model	
	Maverick R	420956127

SPARK PLUGS

Spark Plugs	Models	
	Traxter HD5 2017–2021	715900352
	Traxter HD7 2022 and up	715900785
	Traxter HD8 2016–2021	715901051
	Traxter HD9 2022 and up	715901051
	Traxter HD10 2020 and up	715900244
	Traxter HD11 2026	715900785
	Maverick 1000 2014	715900244
	Maverick 2015–2017	715900357
	Maverick 1000R 2015–2018	715900244
	Maverick Trail 700 2022 and up	715900785
	Maverick Trail 800R/1000 2021 and up	715901051
	Maverick Sport 1000 2019–2022	715901051
	Maverick Sport 1000R 2019 and up	715900244
	Maverick 900HO 2018	415130795
	Maverick 2017 and up (except 900HO)	415130363
	Maverick R 2024 and up	715900935

BATTERIES

Yuasa Batteries	Models	Type	Amp-hours	
	Traxter (base/DPS models)	Yuasa YTX20L fact. activated	18	410301203
	Traxter (except Base/DPS models)	Yuasa YIX30L fact. activated	30	515176151
	Maverick	Yuasa YTX20L fact. activated	18	410301203
	Maverick Sport/Trail	Yuasa YTX20L fact. activated	18	410301203
	Maverick	Yuasa YTX20L fact. activated	18	410301203
	Maverick R (X & X rs)	Yuasa YTX20L fact. activated	18	410301203
	Maverick R (X rc)	Yuasa YIX30L fact. activated	30	515176151

CAN-AM AXLES ARE ENGINEERED TO EXACT TOLERANCES, TESTED TO ENDURE EXTREME LOADS, AND BUILT WITH HIGH-GRADE MATERIALS TO HANDLE HEAT, FLEX, AND ABUSE WITHOUT COMPROMISE.

Genuine Can-Am axles perfectly match drivetrain, steering, and suspension geometries to reduce steering effort, premature wear, and unwanted loads on components such as ball joints, tie-rods and bearings.

Can-Am axles do more than just transmit power. They protect your ride with carefully engineered thresholds, absorbing stress to protect the rest of your drivetrain.

Every Can-Am axle is precision-machined, heat-treated chromium and molybdenum alloy steel, combined with TPE CV boots and friction- and heat-reducing grease, resulting in longer joint life.



HOLD THE POWER. TAKE THE HIT.

Axles act as pressure points in the power system, absorbing stress to help protect more complex and costly components. No weak links. Just smart engineering.



AXLES

	Model / Package / Engine*	Years	Front				Rear				
			Right Axle	Left Axle	Boot (diff. side)	Boot (wheel side)	Right Axle	Left Axle	Boot (diff. side)	Boot (wheel side)	
Maverick											
Width 72" (incl. MAX models)	XRS & XRS DPS (Visco-Lok)	2017	705402100	705402099	705401354	705401354	705502362	715900450	715900450		
	XRS Turbo R (Visco-Lok)	2018	705402100	705402099	705401354	705401354	705502362	715900450	715900450		
	XRS Turbo R (Smart-Lok) XMR Turbo R (Smart-Lok) XRC Turbo R (Smart-Lok)	2018–2019	705402048		705401354	705401354	705502362	715900450	715900450		
	RS Turbo R (Visco-Lok)	2020–2021	705402100	705402099	705401354	705401354	705502362	715900450	715900450		
	XRS Turbo & Turbo RR XRC Turbo & Turbo RR XMR Turbo RR	2020–2026	705402048		705401354	705401354	705502362	715900450	715900450		
	RS Turbo RR	2022–2026	705402048		705401354	705401354	705502362	715900450	715900450		
	RS Turbo	2024–2026	705402048		705401354	705401354	705502362	715900450	715900450		
	Width 64" (incl. MAX models)	Base, XDS, XDS DPS (Visco-Lok)	2017	705402098	705402097	705401354	705401354	705502154	715900450	715900450	
XDS Turbo R (Visco-Lok)		2018	705402098	705402097	705401354	705401354	705502154	715900450	715900450		
Base (Visco-Lok) Turbo (Visco-Lok) Turbo R (Visco-Lok)		2018–2020	705402098	705402097	705401354	705401354	705502154	715900450	715900450		
DS Turbo (Visco-Lok) DS Turbo R (Visco-Lok)		2021	705402098	705402097	705401354	705401354	705502154	715900450	715900450		
XRC Turbo (Smart-Lok) XMR Turbo (Smart-Lok)		2018–2021	705401634		705401354	705401354	705502154	715900450	715900450		
XDS Turbo R (Smart-Lok)		2019	705401634		705401354	705401354	705502154	715900450	715900450		
XDS Turbo (Smart-Lok) XDS Turbo RR (Smart-Lok)		2020–2021	705401634		705401354	705401354	705502154	715900450	715900450		
DS Turbo & Turbo RR XMR Turbo RR XRC Turbo RR XDS Turbo RR		2022–2026	705401634		705401354	705401354	705502154	715900450	715900450		
Maverick R											
All models		2024	705402490		715900450	715900450	705503778	715500542	715500543		
Base X XRS		2025–2026	705402490		715900450	715900450	705503778	715500542	715500543		
Base MAX X MAX XRS MAX XRC & XRC MAX	2025–2026	705402490		715900450	715900450	705503943	715500551	715900929			
Traxter G1											
Base / DPS (incl. MAX models)	Base HD5 DPS HD5	2017–2021	705401936	705401937	705401355	705401345	705502479	705502478	705501864	705501864	
	Base HD7 DPS HD7	2022–2026	705402750	705402749	705401355	705401345	705503100		705501864	705501864	
	Base HD8 DPS HD8	2016–2021	705401936	705401937	705401355	705401345	705502451	705501864	705501864		
	Base HD9 DPS HD9	2022–2026	705401936	705401937	705401355	705401345	705502451	705501864	705501864		
	Base HD10 DPS HD10	2016–2019	705401936	705401937	705401355	705401345	705502451	705501864	705501864		
	DPS HD10	2020–2026	705402407	705402408	705401355	705401345	705502831	705501864	705501864		
	CAB HD8	2019	705402170	705402171	705401355	705401345	705503051	705501864	705501864		
	CAB HD10	2018–2019	705402170	705402171	705401355	705401345	705503051	705501864	705501864		
	DPS CAB HD8	2021	705402449	705402450	705401355	705401345	705503051	705501864	705501864		
	DPS CAB HD9	2022	705402449	705402450	705401355	705401345	705503051	705501864	705501864		
	DPS CAB HD9	2023–2026	705403204	705403205	705401355	705401354	705503051	705501864	705501864		
	XT / XTP / XU (incl. MAX models)	XT HD8 XU HD8	2016–2021	705401936	705401937	705401355	705401345	705502451	705501864	705501864	
		XT CAB HD8 XT CAB HD10	2016–2017	705401936	705401937	705401355	705401345	705502451	705501864	705501864	
		XT CAB HD8	2018	705402170	705402171	705401355	705401345	705503051	705501864	705501864	
		XTP HD10	2018	705401936	705401937	705401355	705401345	705502451	705501864	705501864	
2019			705402353		705401355	705401345	705502451	705501864	705501864		
2020			705402407	705402408	705401355	705401345	705502831	705501864	705501864		
XT CAB HD10 XT CAB HD8		2020	705402449	705402450	705401355	705401345	705503051	705501864	705501864		
XU HD7		2022–2026	705402750	705402749	705401355	705401345	705503100	705501864	705501864		
XT HD9 XU HD9		2022–2026	705401936	705401937	705401355	705401345	705502451	705501864	705501864		
XU HD10		2023–2025	705402407	705402408	705401355	705401345	705502831	705501864	705501864		
XT HD10	2020–2026	705402407	705402408	705401355	705401345	705502831	705501864	705501864			

*Includes MAX models unless otherwise specified.

AXLES

	Model / Package / Engine*	Years	Front				Rear			
			Right Axle	Left Axle	Boot (diff. side)	Boot (wheel side)	Right Axle	Left Axle	Boot (diff. side)	Boot (wheel side)
Traxter G1 (continued)										
Limited / Lone Star (incl. MAX models)	Lone Star HD10	2018–2019	705402170	705402171	705401355	705401345	705503051	705501864	705501864	
	Limited CAB HD10 Lone Star HD10	2020	705402449	705402450	705401355	705401345	705503051	705501864	705501864	
	Mossy Oak Edition HD10	2020	705402575		705401355	705401354	705503051	705501864	705501864	
	Limited CAB HD10 Lone Star HD10 Lone Star CAB HD10	2021–2022	705402449	705402450	705401355	705401345	705503051	705501864	705501864	
	Limited CAB HD10 Lone Star HD10 Lone Star CAB HD10	2023	705403204	705403205	705401355	705401354	705503051	705501864	705501864	
XMR (incl. MAX models)	Lone Star HD10 Lone Star CAB HD10 Limited HD10	2024–2025	705402420		705401355	705401354	705503051	705501864	705501864	
	XMR HD10	2018	705402228		705401355	705401354	705503051	705501864	705501864	
	XMR HD10	2019–2025	705402420		705401355	705401354	705503051	705501864	705501864	
Traxter PRO G1										
Pro	Pro HD8 Pro HD10	2018–2019	705401936	705401937	705401355	705401345	705502451	705501864	705501864	
	Pro DPS HD10 Pro XT HD10	2020–2026	705402407	705402408	705401355	705401345	705502831	705501864	705501864	
	Pro LoneStar HD10 Pro Limited CAB HD10	2021–2022	705402449	705402450	705401355	705401345	705503051	705501864	705501864	
	Pro Limited CAB HD10	2023	705403204	705403205	705401355	705401354	705503051	705501864	705501864	
	Pro Limited CAB HD10	2024–2026	705402420		705401355	705401354	705503051	705501864	705501864	
Traxter 6x6 G1										
6x6							2nd (middle) axle	3rd (rear) axle		
	6x6 DPS HD10	2020–2022	705402407	705402408	705401355	705401345	705502831	705502850	705501864	705501864
	6x6 XT HD10	2021–2022	705402407	705402408	705401355	705401345	705502831	705502850	705501864	705501864
	6x6 Limited CAB HD10	2022	705402449	705402450	705401355	705401345	705503051	705503271	705501864	705501864
	6x6 DPS HD10 6x6 XT HD10	2023–2026	705402407	705402408	705401355	705401345	705502831	705502831	705501864	705501864
	6x6 Limited HD10	2023	705403204	705403205	705401355	705401354	705503051	705501864	705501864	
	6x6 Limited HD10	2024–2026	705402420		705401355	705401354	705503051	705501864	705501864	
Traxter G2										
Incl. MAX models	LoneStar & LoneStar CAB Limited CAB XMR	2026	705403358		715901035	715901034	705503483	715901063	715901064	
	XT & XT CAB XU	2026	705403360	705403361	715901035	715901034	705503483	715901063	715901064	
Maverick Trail										
Width 50'	Trail DPS 1000R	2018–2019	705402007	705402008	705401355	705401345	705502541	705501864	705501864	
	Trail Base & DPS 800	2018–2021	705402007	705402008	705401355	705401345	705502541	705501864	705501864	
	Trail Base & DPS 1000	2018–2026	705402007	705402008	705401355	705401345	705502541	705501864	705501864	
	Trail Base & DPS HD7/700	2022–2026	705402879	705402880	705401355	705401345	705502541	705501864	705501864	
Maverick Sport										
Incl. MAX models	Base 1000 DPS 1000	2019–2022	705402030	705402031	705401355	705401345	705502552	705501864	705501864	
	DPS 1000R	2019–2026	705402030	705402031	705401355	705401345	705502552	705501864	705501864	
	XMR 1000R XRC 1000R	2019–2026	705402282		705401355	705401354	705502757	705501864	705501864	
	XXC 1000R	2020–2023	705402282		705401355	705401354	705502757	705501864	705501864	

*Includes MAX models unless otherwise specified.

BALL JOINT

Suspension Arm Ball Joint with Hardware



Models

Lower

All models & packages except Maverick R, 2015-2026

Maverick R, all packages, 2024-2026

—

Upper

Maverick R, 2024-2026

Traxter, G1 & G2, all packages 2017-2026
Maverick, All Packages, 2018-2026
Maverick Sport & Trail, all packages 2018-2026

Maverick G1, 2014-2018

703501262

703501263

703501264

Strength, stability, and control. Can-Am A-arms and ball joints are built to keep the suspension locked in and tires planted. Engineered for max articulation, impact resistance, and durability in brutal terrain, they help keep machines running and riders moving.

MADE TO FLEX. BUILT TO HOLD.

High-strength ball joints absorb punishing hits and deliver full-angle movement without binding. Superior sealing and lubrication keep dirt out and performance in. Designed to maintain contact with the ground, because traction means control, and control means confidence.



These are the same high-performance pads installed at the factory, now available in complete kits for quick, full replacements. Engineered with Can-Am, in collaboration with Brembo, to deliver consistent stopping power, even in the toughest off-road conditions.

BUILT FOR BRUTAL STOPS

These pads are optimized for off-road abuse, built to handle heat, grit, and repeat impact. Every kit includes the right components for a full pad swap, with stopping power that never backs down.

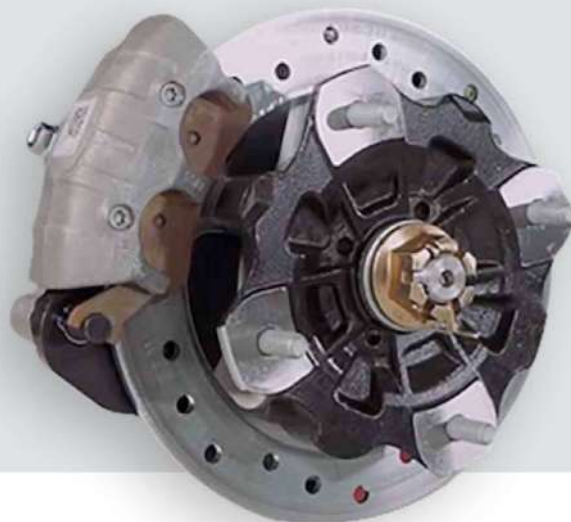

BRAKE PADS

Brake Pad Kits

Include left and right pads, spring and pin



Models	Front	Rear
Maverick R	703501223	703501226
Traxter HD7	703501198	703501200
Traxter HD9		
Traxter HD10		
Traxter PRO		703501199
Traxter 6X6		
Traxter HD7 MAX		
Traxter HD9 MAX		
Traxter HD10 MAX		
Maverick		
Maverick Sport		
Maverick Trail		



Engineered to fit each Can-Am model, BRP drive belts are precisely calibrated to match clutch systems for maximum transfer, zero RPM loss, and unmatched throttle response. Field-tested and race-proven, they're built to take the heat. Literally.

DESIGNED TO PERFORM. PROVEN TO WIN.

From dyno to desert, BRP drive belts are tested in brutal real-world and race conditions.



1

THE TOP COG

adds strength and limits deformation. It's made from a different compound than the lower cog to suit distinct power transfer roles.

2

ADHESION LAYERS

promote bonding between the cogged undercord compound and the aramid cord.

3

THE TENSILE CORD

is made with lightweight, high-strength aramid cords, each layer matched to your vehicle's specific power and performance demands.

4

THE UNDERCORD

is a custom mix of natural/synthetic rubbers and high-performance materials, designed for ideal flex and clutch engagement.

5

IMPREGNATED FABRIC

boosts wear resistance for both the belt and your clutches.

BELTS

Drive Belts	Models	CVT Drive Belt	Belt Upgrade	CVT Cover Gasket
	Traxter HD5 2017-2021	422280283	—	—
	Traxter HD7 2022 and up	422280225	—	—
	Traxter HD8 2016-2021	422280656	422280652	—
	Traxter HD9 2022 and up	422280656	422280652	420450400
	Traxter HD10 2018-2019	422280656	422280652	—
	Traxterr HD10 2020 and up	422280652	—	420450400
	Traxter HD11 2026	422280652	—	—
	Maverick Trail 700 2022 and up	422280225	—	—
	Maverick Sport/Trail 1000 2018 and up	422280656	422280652	420450400
	Maverick 2018 and up (except 900HO)	422280652	—	420450405
	Maverick 900HO 2018	422280656	422280652	—

PDRIVE MAINTENANCE KITS

pDrive Maintenance Kits	Models	Torque Rollers Maintenance Kit	Ramp Rollers Maintenance Kit
 420629224 420629237	Traxter HD7 2022 and up	420629224	420629237
	Maverick Trail 700 2022 and up		
	Maverick Turbo 2023 and up		
	Maverick Turbo RR 2022 and up		

QRS ROLLERS

QRS XD Roller Kit (pack of 3)	Models	
	Traxter HD9 2022 and up	861805583
	Traxter HD10 2020 and up	
	Traxter HD11 2026	
	Maverick Sport 1000R 2019 and up	
	Maverick Turbo/Turbo R 2018 and up	
	Maverick Turbo RR 2020 and up	
	Maverick 900HO 2018	
Maverick 2017-2018		

QRS XD Roller Kit (pack of 2)	Models	
	Traxter HD8 2016-2021	861805577
	Traxter HD10 2016-2019	
	Maverick 1000 Turbo XDS 2015-2017	
	Maverick Sport 1000 2019-2022	
	Maverick Trail 800/800R 2018-2021	
	Maverick Trail 1000 2018 and up	

DUPLICATE OF LOAD APPLIED

DEFORMATION RESISTANCE UNDER STATIC COMPRESSION TEST

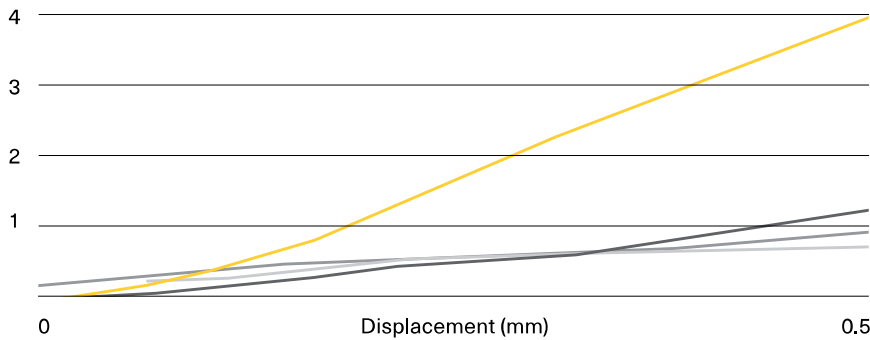

BRP XD roller

The **BRP XD roller** withstands 4 times the load in compression compared to most popular aftermarket thermoplastic-type rollers with a displacement/deformation of 0.5 mm.

QRS XD rollers are built to take a beating. With more impact resistance and less deformation than standard designs, they hold up under pressure, protect belt performance, and keep the pulley system running clean and smooth, ride after ride.

BUILT TOUGH TO KEEP POWER MOVING

Stronger than fiber rollers and more stable than thermoplastic designs, QRS XD rollers resist high-impact shocks and deformation that can seize pulleys or shred belts. A major upgrade for reliability, durability, and consistent performance under stress.



CYCLING TEST

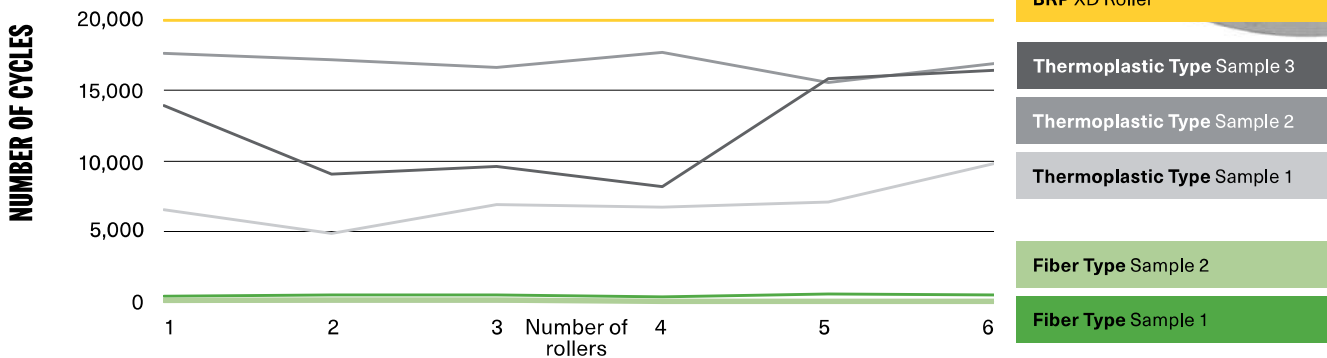

BRP XD Roller

Thermoplastic Type Sample 3

Thermoplastic Type Sample 2

Thermoplastic Type Sample 1

Fiber Type Sample 2

Fiber Type Sample 1

The **BRP XD rollers** performed 40% more cycles* than the average for thermoplastic-type rollers and 99% more cycles* than the average for fiber-type rollers. Both thermoplastic and fiber roller tests ended in failure.

*Based on 20,000 cycles of our XD rollers, without any signs of failure.



XPS

A TIRE FOR EVERY PURPOSE.



XPS TIRES

aren't just made to fit your vehicle, they're made to work perfectly with it.

DESIGN

Designed and engineered specifically for Can-Am, all tread patterns and tire aspects have been crafted to exact XPS specifications, giving you an exclusive tire designed to perform like no other.

TESTING

Every XPS tire goes through extreme testing—such as puncture, mileage, speed rating, and weight—to meet the same performance standards as your Can-Am vehicle.

COMPLETE LINEUP

The fast-growing lineup of XPS tires covers a vast range of the most popular sizes and specifications. ATV or SSV, 6- or 8-ply rating, radial or not, XPS has a purpose built tire for your playground.

XPS TIRES

SHOP BY USAGE



NEW XPS Hammer King



- 8-ply rated construction.
- Flatter tire profile for large contact patch.
- Tread pattern is tighter to help float over desert type terrain and keep ride smoother at high speeds.
- Aggressive sidewall for increased traction when in rocky terrain.
- Tread depth: 15 mm (0.6").

705403785 · UT 32X10R15
705403945 · UT 30X10R14
705403683 · UT 35X10R16
705403784 · UT 30X10R15

XPS Hammer Force



- Light truck-inspired tire.
- 8-ply rated construction.
- Rock-crawling tread pattern with unique contact patch.
- Aggressive sidewall for maximum traction when faced with technical terrains.
- Tread depth: 15 mm (0.6").

705402918 · 30X10R15

XPS Trail King 2



- All-terrain radial tire.
- 8-ply rated construction.
- Tire excels in various terrains, from loose to hard packed.
- Non-directional tread pattern with optimized construction providing precision handling and ensuring maximum grip and low rolling resistance
- Tread depth: 20 mm (0.8").

705403482 · 29X9R14
705403663 · 29X11R14

XPS Trail King



- All-terrain radial tire.
- 8-ply rated construction.
- Aggressive tread pattern for tougher terrains.
- An almost continuous center tread offers a smoother trail ride.
- Tread depth: 26 mm (1.02").

705403081 · 27X9R14
705503355 · 27X11R14
705402825 · 28X9R14
705503181 · 28X11R14

XPS Trail Force



- All-terrain radial tire.
- 8-ply rated construction.
- Versatile and suitable for many types of terrain.
- Aggressive tread pattern for better traction on dirt, mud and rocky terrains.
- Tread depth: 20 mm (0.78").

705402754 · 27X9R14
705503103 · 27X11R14

XPS Trac Force



- All-terrain light truck style radial tire.
- 8-ply rated construction.
- Central tread for good grip and comfort on compact terrain.
- Tread depth: 18 mm (0.71").

705403080 · 30X9R14	\$275.49
705403369 · 30X9R15	\$275.49
705503354 · 30X10R14	\$285.99
705403586 · UT 30X10R14*	\$285.99

705403370 · 30X10R15
705403416 · UT 32X10R16*
705403587 · UT 32X10R15*
*6 ply rating

XPS Swamp King



- Radial tires for mud and trail.
- 8-ply rated construction.
- Ultimate performance in mud without sacrificing good trail handling.
- Tread depth: 38 mm (1.5").

705503855 · UT 30X10R15

XPS Swamp Force



- Hybrid radial tire for mud and trail.
- 8-ply rated construction.
- Unique tread pattern allowing good grip in mud and mud ejection.
- Center tread provides for comfortable trail riding.
- Tread depth: 36-38 mm (1.41"-1.5").

705403201 · 30X9R14
705503387 · 30X11R14



Powersport engines are some of the most powerful for their size. This reality creates a lot of pressure and stress on all components, including oils and lubricants. Finding the right balance between lubrication and durability is hard, but that's exactly what you'll find in every XPS bottle. Our chemistry evolved over thousands of testing hours to deliver power and durability like only XPS can.

XPS

OIL THAT GOES THE DISTANCE



XPS OILS

Developed as an integral part of the engine and vehicle, XPS lubricants don't settle for a certification. Always looking for more power and torque is in our DNA. This quest for performance created our need for specifically engineered lubricants.

LUBRICANT & OIL CHANGE KIT

LUBRICANT

XPS 4T 10W-50 Synthetic Oil



- Engineered for heavy-duty and high-performance 4-stroke engines, including turbocharged, supercharged and racing engines.
- Formulated using carefully selected and strenuously tested base stocks and custom additives.
- Offers thick film strength to protect bearings and a proven high-temp detergency to minimize deposits, prevent shear, provide thermal stability, and combat fuel dilution to ensure maximum performance from your engine.

9779234 • (US) 1 qt / 946 ml
9779240 • (EU) 1 qt / 946 ml
9779235 • 1 US gal / 3.785 L

XPS 4T 0W-40 Synthetic Oil



- Powersport formula with premium anti-wear and anti-corrosion additives.
- The best choice for high-performance snowmobile, ATV and SXS 4-stroke engines used in cold weather.
- Provides superior engine and transmission protection against heat, rust and corrosion.
- Delivers optimal performance in high and low temperatures.

9779139 • (US) 1 qt / 946 ml
9779286 • (EU) 1 qt / 946 ml
9779140 • (US) 1 US gal / 3.785 L
9779287 • (EU) 1 US gal / 3.785 L

XPS 4T 5W-40 Synthetic Oil



- Off-road formula with premium anti-wear and anti-corrosion additives.
- Designed for high-performance off-road, on-road and PWC 4-stroke engines, including turbo or supercharged powersports engines.
- Provides superior engine and transmission protection against rust and corrosion, even in extreme conditions.

9779492 • (US) 1 qt / 946 ml
9779900 • (EU) 1 qt / 946 ml
9779493 • (US) 1 US gal / 3.785 L
9779901 • (EU) 1 US gal / 3.785 L

OIL CHANGE KIT

Engine Oil Change Kit



- Ultra-convenient "all-in-one" Engine Oil Change Kit saves time and money.
- Includes XPS Synthetic or Synthetic Blend Oil, oil filter, O-rings and washer.

Engine	Product	
Mono Cyl		
450 cc or less	Can-Am Oil Change Kit 5W40	9779487 (US) 9779954 (EU)
ACE 650 cc Single Cylinder	Can-Am Oil Change Kit 5W40	9779480 (US) 9779952 (EU)
ACE 650 cc Single Cylinder	Can-Am Oil Change Kit 0W40	9779481 (US) 9779417 (EU)
VTwin		
500 cc + V-Twin	Can-Am Oil Change Kit 5W40	9779488 (US) 9779953 (EU)
500 cc + V-Twin	Can-Am Oil Change Kit 0W40	9779259 (US) 9779406 (EU)
500 cc + V-Twin	Can-Am Oil Change Kit 10W50	9779252 (US) 9779401 (EU)
3 Cyl		
Rotax 999T	Can-Am Oil Change Kit 5W40	9779500 (US) 9779959 (EU)
Rotax 999T	Can-Am Oil Change Kit 10W50	9779501 (US) 9779960 (EU)
Rotax 900 ACE	Can-Am Oil Change Kit 5W40	9779489 (US) 9779955 (EU)
Rotax 900 ACE	Can-Am Oil Change Kit 10W50	9779261 (US) 9779411 (EU)
Rotax 999 ACE	Can-Am Oil Change Kit 5W40	9779502 (US) 9779961 (EU)
Rotax 999 ACE	Can-Am Oil Change Kit 10W50	9779503 (US) 9779963 (EU)
Rotax 900/999 ACE	Can-Am Oil Change Kit 0W40	9779504 (US) 9779962 (EU)

MAINTENANCE PRODUCTS

Synthetic Gear Oil

75W-90

75W-140

9779158 • (US) 1 qt / 946 ml

9779212 • (EU) 1 qt / 946 ml

9779160 • (US) 1 qt / 946 ml

9779215 • (EU) 1 qt / 946 ml



- Uses custom additives to provide the best performance in Visco-Lok™ and Smart-Lok™ differentials.
- Allows higher loads, superior shear stability and reduced oxidation.
- Exceptional wear protection and superior performance at all operating temperatures.

XPS Synthetic DCT Fluid

9779710 • (US) 1 qt / 946 ml

9779473 • (EU) 1 qt / 946 ml



- Meets or exceeds API GL-4 industry specifications.
- Formulated for dual clutch system.
- Enhanced cooling capabilities for optimal clutch functionality.
- Anti foaming agents for smooth hydraulic function.

XPS DCT Oil Change Kit

9779725 (US)

9779910 (EU)



- Ultra-convenient "all-in-one" Oil Change Kit saves time and money.
- Includes XPS Synthetic Oil, oil filter, O-rings and washers.

Extended Life Pre-Mixed Coolant

9779150 • 1 qt / 946 ml

619590728 • (Scandinavia) 1 qt / 946 ml



- Antifreeze/coolant contains the correct dilution and the necessary additives to prevent corrosion and inhibit cavitation in BRP cooling systems.
- Long-life, 5-year formula specially formulated for BRP vehicles.
- Superior heat transfer.
- Ideal replacement for vehicles that normally use a 2-year antifreeze/coolant (green).
- 5 years (orange).

DOT 4 Brake Fluid

9779151 • (US) 12 fl oz / 355 ml

9779207 • (EU) 12 fl oz / 355 ml



- Meets or exceeds all DOT3 and DOT4 brake fluid requirements.
- High-temperature formula resists fade and also conditions seals and O-rings in braking system.

Racing Brake Fluid RS600

9779152 • 12 fl oz / 355 ml



- Exceeds DOT4 brake fluid requirements for extreme conditions and competition use.
- Extreme, 579-degree boiling point temperature is ideal for high-demand competition conditions to combat brake fade.
- Will not harm seals or braking system components.
- Should be added only to a clean/unfilled system to avoid dilution and diminished performance.
- Low-moisture formula slows water vapor absorption through multiple heat cycles.
- Recommended for use in Ski-Doo and Can-Am racing applications.

Fuel Stabilizer

9779171 • (US) 8 fl oz / 236 ml

9779183 • (EU) 8 fl oz / 236 ml



- Ethanol-compatible and will stabilize fuel in your tank to keep it from breaking down and causing hard starting, throttle hesitation and poor run quality.
- Since ethanol attracts moisture, this product contains powerful anti-corrosion additives to protect fuel system components.
- Prevents problems associated with E10 fuels.

Anti-Corrosive Lubricant

9779701 • 12 oz / 340 g
619590733 • (Scandinavia) 12 oz / 340 g



- Multipurpose lubricant that can also be used to prevent rust, corrosion and moisture intrusion.
- It contains extreme pressure additives that work as an all-around lubricant for just about anywhere lubrication is needed.

Extreme Duty Suspension Grease

9779708 • 14 oz / 400 g



- Designed to work specifically with the components found in Can-Am vehicle suspensions.
- It is highly stable and offers optimal lubrication at both extreme cold and high temperatures while protecting suspension components from dirt and moisture, as well as corrosion under extreme washout conditions.

XPS Spline Grease

9779704 • 3 fl oz / 118 ml



- Formulated with molybdenum disulfide and synthetic graphite for maximum durability and long-lasting protection.
- High performance formula that protects against wear, seizure, rust, corrosion, and extreme temperatures.
- Ensures smooth assembly and disassembly, with consistent low-friction performance.

CAN-AM APPAREL



CAN-AM APPAREL

Sizing chart	220
Communication systems	221
Helmets and goggles	223
Mud gear	227
Rainwear	227
Gloves	228
Can-Am x Fasthouse	230
Everyday wear	237
Signature collection	241
UV Protection and Play	246
Play and licensing products	247
Replacement parts	248

Always use the digital version
of the Products Spec Book for
the most updated information.





SIZING CHART

HOW TO MEASURE

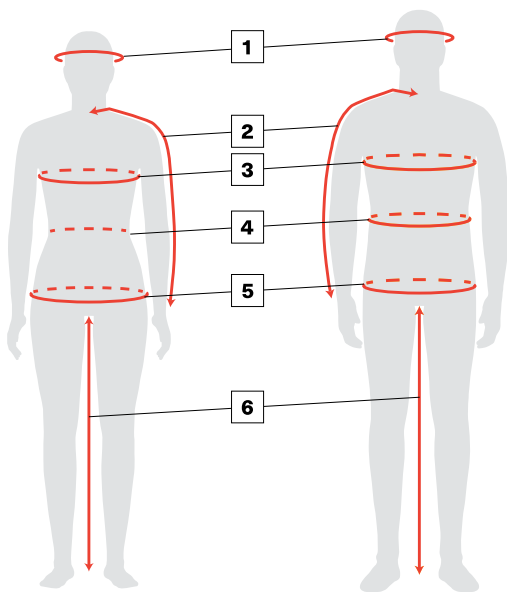

- For best results, have someone else take measurements.
- Measure body in underwear.
- Tape must be snug but not tight.
- If measurements fall between two sizes, order the larger size.

1 HEAD	Around your head, from the center of the forehead, above the ears and over the natural bump at the back of the head.
2 ARM LENGTH	Let the hands hang down on the side in a slightly bent position. Measure from the center of the back of your neck, along the length of your arm, to the wrist.
3 CHEST/BUST	Measure under your arms, around the fullest part of your chest.
4 WAIST	Measure around your natural waistline, keeping one finger between the tape and body.
5 HIPS	Across the widest part of the seat.
6 INSEAM	Without shoes, from your crotch to the floor.

DID YOU KNOW?

We redefined our fit for all of our new collections. You now have three categories for our riding gear and sportswear items. You can find the fit of each style in their description so you know what you are getting.

FIT GUIDE

Sportswear



Riding Gear

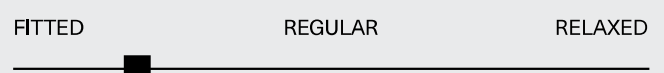

VIBE ON ANY HELMET

The Vibe Communication System delivers unparalleled connectivity and versatility when you ride. Fully compatible with most BRP helmets, this comm system might as well be an extension of the vehicle's ecosystem. This standout lets you chat, listen and ride all day long in comfort no matter how cold it is!



ONE CLICK TO CONNECT WITH OTHER MESH RIDERS	UNPARALLELED TALK TIME UP TO 12 HOURS (8 HOURS AT 0 °F)
SOUND BY HARMAN/KARDON®	OPEN MESH INTERCOM
UNIVERSAL FIT AND EASY TOOLLESS ASSEMBLY	FULL COMPATIBILITY WITH MOST HELMETS

DID YOU KNOW ABOUT VIBE AND THE BRP GO! APP?
Ready, set, go! Set up and manage the Vibe Communication System in no time directly in the free BRP GO! mobile app. You can check the battery level, modify the audio settings and much more!



OPEN MESH INTERCOM: LIMITLESS



MULTI-LANGUAGE VOICE COMMAND



GROUP MESH INTERCOM: UP TO 24 RIDERS



INTERCOM UP TO 2 KM / 1.2 MILES IN OPEN TERRAIN

COMMUNICATION SYSTEMS

	Vibe Universal Comm System by BRP	929105 • One size	Matte Black (93)
MISC		<ul style="list-style-type: none"> VIBE UNIVERSAL Comm System with superior audio quality for most BRP helmets. Sound by Harman Kardon®. Mesh-only system: Robust reliability compatible with all Sena Mesh devices. Battery capacity: up to 12 hours of talk time (8 hours at 0 °F). One-click-to-connect simplicity with other mesh riders. Mesh Intercom™ features superior audio quality. Up to 2 km/1.2 miles in open terrain. Range can be extended with multiple riders. Multi-channel protocol in open mesh allows users to switch between nine comm channels. 	<ul style="list-style-type: none"> Convenience of voice-activated digital assistant access ("OK Google"/"Hey Siri"). Rapid charging. Glove-friendly interface. Compatible with all BRP helmets. When paired with the BRP GO! app, you can manage many settings such as sound, mesh channel options, software updates, battery level, handlebar control and more. Wired and boom microphones included. 3-year limited warranty.
			<p><i>For safety reasons, the battery cannot be charged while riding. Considering the increased risks inherent in charging a battery, BRP has chosen NOT to make this action possible to guarantee maximum user safety.</i></p>

PYRA AND FLINT: BETTER THAN EVER!

The Can-Am Pyra helmets: where style meets performance. With the lightest helmet in our collection featuring high airflow and ERT protection, you'll be covered!

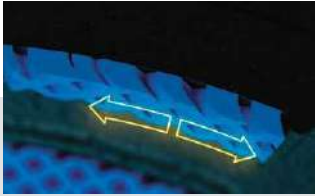

PROTECTION

Energy Reduction Technology (ERT) redirects force away from the head in the event of a fall.



LIGHTWEIGHT

Our lightest helmet starting at 1,240 g.



AIRFLOW

Don't sweat the ride with an open chin, removable wind deflector and rear vents.

- LIGHTWEIGHT 
- ACCESSIBLE 
- DOT/ECE 

PERFECT FIT!

Experience unmatched comfort and fit with the Flint goggles and Pyra helmet—the ideal combination for your ride.



Can-Am Pyra Phantom Helmet
GREY
929159_09



Can-Am Flint Phantom UV Goggles
RED
286834_30



Can-Am Pyra Phantom Helmet
BLACK
929159_90



Can-Am Flint Phantom UV Goggles
SMOKE
286834_57

The Can-Am Flint goggles feature an injected PC lens that is anti-scratch and anti-fog and has distortion-free optics.

- ✓ UV protection
- ✓ Anti-fog
- ✓ Anti-scratch
- ✓ Frameless
- ✓ Designed to fit with the Pyra helmet

Second lens included



HELMETS AND GOGGLES

UNISEX

Can-Am Pyra Phantom Helmet

DOT ECE2206

929159 • XS, S, M, L, XL, 2XL, 3XL

Black (90), Grey (09)



- 4-year limited warranty.
- Advanced plastic-composite shell with Energy Reduction Technology (ERT).
- Two-position adjustable peak.
- Front and rear hi-max air vent system to maximize cooling.
- Removable, washable and replaceable moisture-wicking liner.
- Lightweight double-D chin strap.
- Weight: ±1,270 grams for size Large.
- DOT/ECE 2206 certified.

Can-Am Pyra Fade Helmet

DOT ECE2206

929078 • XS, S, M, L, XL, 2XL, 3XL

Beige (02), Turquoise (Aqua) (76), White (01)



- 4-year limited warranty.
- Advanced plastic-composite shell with Energy Reduction Technology (ERT).
- Two-position adjustable peak.
- Front and rear hi-max air vent system to maximize cooling.
- Removable, washable and replaceable moisture-wicking liner.
- Lightweight double-D chin strap.
- Weight: ±1,310 grams for size Large.
- DOT/ECE 2206 certified.

Can-Am Pyra Helmet

DOT ECE2206

929038 • XS, S, M, L, XL, 2XL, 3XL

Charcoal Grey (07)



- 4-year limited warranty.
- Advanced plastic-composite shell with Energy Reduction Technology (ERT).
- Two-position adjustable peak.
- Front and rear hi-max air vent system to maximize cooling.
- Removable, washable and replaceable moisture-wicking liner.
- Lightweight double-D chin strap.
- Weight: ±1,310 grams for size Large.
- DOT/ECE 2206 certified.

Can-Am Flint Phantom UV Goggles

286834 • One size

Red (30), Smoke (57)



- The Can-Am Flint Phantom goggles feature an injected PC lens that is anti-scratch and anti-fog and has distortion-free optics.
- Thermo-formed 3-layer face foam offers best fit.
 - No-slip silicone strap keeps goggles in place.
 - Injection-molded PC cylindrical lens provides distortion-free vision and enhanced impact resistance.
- Tinted lens with anti-scratch and anti-fog performance with mirrored coating.
 - Included extra clear lens for low-light conditions.
 - Removable nose guard for extra deflection against debris.

Can-Am Flint Photochromic Goggles

448779 • One size

Charcoal Grey (07)



- Thermo-formed 3-layer face foam offers best fit.
- No-slip silicone strap keeps goggles in place.
- Injection-molded PC cylindrical lens provides distortion-free vision and enhanced impact resistance.

- Lens VLT from 80% to 28% with anti-scratch and anti-fog performance and with mirrored coating.
- Removable nose guard for extra deflection against debris.

Can-Am Trench UV Goggles

448696 • One size

Charcoal Grey (07), White (01)



- The Can-Am Trench goggle features injection PC lens that is anti-scratch and anti-fog and has distortion-free optics.
- Thermo-formed 3-layer face foam offers best fitting.
 - No-slip silicone strap keeps goggles in place.

- Injection-molded PC cylindrical lens provides distortion-free vision and enhanced impact resistance.
- Single lens with anti-scratch and anti-fog performance.
- Removable nose guard for extra deflection against debris.

Can-Am Trench OTG Goggles

448792 • One size

Matte Black (93)





- The Can-Am Trench OTG goggles feature an injected PC lens that is anti-scratch and anti-fog and has distortion-free optics.
- Thermo-formed 3-layer face foam offers best fit.
 - No-slip silicone strap keeps goggles in place.
 - Injection-molded PC cylindrical lens provides distortion-free vision and enhanced impact resistance.

- Single lens with anti-scratch and anti-fog performance.
- Removable nose guard for extra deflection against debris.
- Fits over most of the prescription glasses on the market with lens height below 2 in. (51 mm) and with arm width of 5 ¼ in. (146 mm).



FULL-FACE ACCESSIBILITY

 LIGHTWEIGHT
 DOT ECE 2206

Open-Face Helmets

Designed for freedom and visibility. Offering a wide field of vision, allowing you to better enjoy the scenery and stay aware of your surroundings. You'll be sure to be comfortable with these stylish and ultra-light helmets.



BLACK WITH GRAPHICS
929150_94

MATTE BLACK
929140_93 (US)
929185_93 (Europe)

LIGHTWEIGHT

Advanced light-plastic composite shell. Enjoyable for short or longer rides.

OPEN-FACE HELMET

Perfect for full-face accessibility.

COMFORT

Ultra-comfortable and washable linings.

UNISEX	NEW Can-Am Retro Open Face Helmet	DOT	929150 - S, M, L, XL, 2XL	Black with Graphics (94), Matte Black (93)
			<ul style="list-style-type: none"> Advanced thermoplastic shell. Multi-density EPS. 2 shell sizes and 3 EPS sizes for better fit and comfort. Removable peak. Ultracomfort, removeable and hand-washable linings. 	<ul style="list-style-type: none"> Quick-release chin strap. Eyewear compatible. Communication system-ready. Fit: Medium Oval. DOT-certified. <p>Weight</p> <ul style="list-style-type: none"> - XS-L: 1,140 g ± 50 g. - XL-XXL: 1,200 g ± 50 g. - Not available in Europe.
	Can-Am Exome Helmet	DOT ECE2206	929040 - XS, S, M, L, XL, 2XL, 3XL	Sand (03), Charcoal Grey (07)
			<ul style="list-style-type: none"> Perfect for adventure riding, on or off the trails. Modular helmet with advanced plastic-composite shell. Pinlock-ready multi-position and anti-scratch visor. Interchangeable retractable sun visor. Removable aerodynamic peak. Ultra-comfortable washable linings. Adjustable air vents and exhausts. DOT/ECE 2206 certified. 	
Can-Am Exome Open-Face Helmet	DOT	929140 (US) - XS, S, M, L, XL, 2XL, 3XL	Grey (09), Matte Black (93)	
		<ul style="list-style-type: none"> Perfect for adventure riding, on or off the trails in summer conditions. Advanced plastic composite shell. Anti-scratch amber visor. Interchangeable retractable sun visor. Fixed aerodynamic peak. Ultra-comfortable washable linings. Adjustable air vents and exhausts. DOT-certified. - Not available in Europe. 		
NEW Can-Am Exome Open-Face Helmet	ECE2206	929185 (Europe) - XS, S, M, L, XL, 2XL, 3XL	Matte Black (93)	
		<ul style="list-style-type: none"> Perfect for adventure riding, on or off the trails in summer conditions. Advanced plastic composite shell. Anti-scratch amber visor. Interchangeable retractable sun visor. Fixed aerodynamic peak. Ultra-comfortable washable linings. Adjustable air vents and exhausts. ECE 2206 certified 		

HELMETS

MEN'S & WOMEN'S

	2XS	XS	S	M	L	XL	2XL	3XL
Sizing Code	01	02	04	06	09	12	14	16
Head (inches)	20 7/8-21 1/4	21 5/8-22	22 3/8-22 3/4	23 1/8-23 5/8	24-24 3/8	24 3/4-25 1/8	24 3/4-25 1/8	25 1/2-25 7/8
Head (cm)	53-54	55-56	57-58	59-60	61-62	63-64	63-64	65-66

PHANTOM

Introducing the beloved Phantom collection

Built for riders who demand more. Featuring a 100% waterproof jacket and pants, but also protective gear such as helmet and goggles. All of them showcasing the striking phantom graphic. Full protection. Maximum style.



Can-Am Pyra
Phantom Helmet
BLACK
929159_90



Can-Am Flint
Phantom UV
Goggles
SMOKE
286834_57



Unisex Can-Am
Waterproof
Mud Jacket
CAMO
456046_37



Unisex Can-Am
Waterproof
Mud Pants
BLACK
456067_90

Unisex Can-Am
Waterproof
Mud Jacket
BLACK
456046_90



MUD GEAR

UNISEX

Can-Am Waterproof Mud Jacket

456046 • S, M, L, XL, 2XL

Black (90), Camo (37)



- Mud jacket made of waterproof PVC.
- 98.5% polyvinyl chloride (PVC), 1.5% mesh polyester.
 - Electronically welded seams.
 - Back panel ventilation (with mesh).
 - Elastic cuffs, hem and hood.
 - Can-Am logo.

Can-Am Waterproof Mud Pants

456067 • S, M, L, XL, 2XL

Black (90), Camo (37)



- Oversized pants made of 100% waterproof PVC.
- 100% polyvinyl chloride (PVC).
 - Electronically welded seams.
 - Elastic waistband and ankle cuff.
 - Can-Am logo.

RAINWEAR

UNISEX

NEW Unisex Can-Am Seil Lite WP Jacket

456072 • S, M, L, XL, 2XL, 3XL

Hi-Vis Yellow (26)



- Simple yet carefully designed and beautifully made lightweight weather protection unisex jacket. 100% waterproof. Intelligent sizing – To be fit over your normal riding gear, sized accordingly.
- Main material: 100% laminated polyester.
 - Fit: Relax.
 - Waterproof/breathable: 10K/3K, 2.5-layer membrane.
 - Hi-vis material at sleeves.
 - Fully seam-sealed.
 - Double storm placket front closure with one-way zipper.
 - Stowable adjustable hood (inside collar).
 - Reflective details and logo.
 - Elasticized cuff with silicone grip inside.
 - Back panel ventilation.
 - Adjustable hem.
 - Lightweight.
 - Unisex sizing to fit over clothes.
 - One size down for women.

NEW Unisex Can-Am Seil Lite WP Overpants

442457 • XS, S, M, L, XL, 2XL, 3XL

Black (90)



- Simple yet carefully designed and beautifully made lightweight weather protection unisex overpants. 100% waterproof. Intelligent sizing – To be fit over your normal riding gear, sized accordingly.
- Main material: 100% laminated polyester.
 - Fit: Relax.
 - Waterproof: 10K/3K, 2.5-layer membrane.
 - Elastic waistband with silicone grip all around.
 - Silicone grip at bottom hem.
 - Fully seam-sealed.
 - Reflective logo.
 - Hem opening with zipper.
 - Stretch boot straps.
 - Lightweight.
 - Unisex sizing to fit over clothes.
 - One size down for women.

GLOVES

MEN'S

NEW Can-Am Rally Gloves

286836 • S, M, L, XL, 2XL, 3XL

Black (90)



Our new Can-Am Rally Gloves are highly breathable for hot riding conditions. Mesh on the upper and light perforated microsuede on the inside of the palm for a perfect grip and air flow.

- 92% polyester, 8% spandex.
- Ventilated air mesh upper construction.
- Reinforcement thumb panel for extra durability.

- Single-layer microsuede palm with minimal padding.
- Stretch finger gussets.
- Embossed and expandable neoprene slip-on cuff.
- Touchscreen function.

GLOVES (measure palm width)

UNISEX

	XS	S	M	L	XL	2XL	3XL
Sizing Code	02	04	06	09	12	14	16
Palm (inches)	3	3¼	3½	4	4½	5	5½
Palm (cm)	7,5	8	9,5	10	11,5	13	14



CAN-AM x FASTHOUSE

Desert racing runs deep in Fasthouse's roots. Their passion is forged by the camaraderie, good times and heritage of Fasthouse is built upon the legacy of those who came before it, while forging its own path by being the Purveyors of Good Times®. This collection merges Fasthouse's aesthetic with Can-Am Off-Road's prowess, a partnership that sets a new benchmark for off-road lifestyle, capturing the core of their shared values and leaving behind a legacy for all to revel in.



Men's Can-Am x FH
Ride Out T-Shirt
BLACK
288225_90



Men's Can-Am x FH
Adventure Long
Sleeve T-Shirt
WHITE
288226_01
BLACK
288226_90

Unisex
Can-Am x FH
Dust Gloves
BLACK
446389_90



Men's Can-Am x FH
Mav T-Shirt
SAND
288218_03
BLACK
288218_90



Women's Can-Am x FH
Adventure T-Shirt
BLACK
288228_90



CAN-AM x FASTHOUSE

MEN'S

NEW Unisex CAN-AM x FH Dust Gloves

446389 • XS, S, M, L, XL, 2XL

Black (90)



The Dust gloves utilize quality materials with a traditional moto fit.

- 77% polyamide, 15% polyurethane, 7% elastane, 1% polychloroprene.
- Durable form-fitting 2-way stretch material.
- Perforated Clarino® palm and thumb guards.

- Touchscreen fingertips on index and thumb.
- Gusseted knuckles for increased dexterity.
- Molded neoprene low-pro cuff.
- Mesh finger gussets and silicone grippers.
- TPR and printed embellishments throughout.

NEW Can-Am x FH Dust Pants

288018 • 28, 30, 32, 34, 36, 38, 40, 42

Black (90)



The Dust pants are designed for those who venture off the beaten path. They feature a classic fit with cargo-style pockets, full-grain leather inner knee panels, and 600D poly main panel construction, all engineered to endure the harshest conditions and enhance your performance for the adventure ahead.

- 69% polyester, 27% nylon, 4% spandex.
- Fit: Fitted
- Zippered cargo pockets.

- Zippered mesh ventilation pockets on both thighs.
- Zippered fly for easy pit stops.
- 600-denier poly and 4-way stretch main body fabric.
- High-strength nylon thread, double- and triple-stitched seams.
- Silky soft tricot, ¾-length knee brace, optimized lining.
- Patterned and fit for every style of rider.

Please refer to the sizing chart below:

Size	Code	Size	Code	Size	Code	Size	Code
28	36	32	38	36	40	40	42
30	37	34	39	38	41	42	43

NEW Can-Am x FH Mav Pullover Hoodie

288227 • S, M, L, XL, 2XL, 3XL

Gold (11)



Midweight hooded pullover for men.

- 80 % cotton, 20% polyester.
- Soft midweight material (280 gsm).
- Fit: Regular.
- Two front welt pockets.
- Metal eyelets and hood drawstring.
- Screen printed graphics.
- Ribbed sleeve cuffs and waistband hem.

NEW Can-Am x FH Triad T-Shirt

288236 • S, M, L, XL, 2XL, 3XL

Black (90), Heather Charcoal (29)



Can-Am x Fasthouse Collab T-Shirt with brand logos and graphics

- 60% cotton, 40% polyester.
- Fit: Slim.
- Ribbed collar.

Can-Am x FH Motorall

441716 • 28, 30, 32, 34, 36, 38, 40, 42

Black (90)



The Motorall® is our tried and true Grindhouse moto pant in an overalls cut.

- 69% polyester, 27% nylon, 4% spandex.
- Fit: Fitted.
- Zippered cargo pockets on front chest and both thighs.
- Zippered mesh ventilation pockets on both thighs.
- Zippered fly for easy pit stops.
- Adjustable elastic comfort straps for step-in entry.

- 600-denier poly and 4-way stretch main body fabric.
- Upper chest molle straps for radios, tools and accessories.
- High-strength nylon thread double- and triple-stitched seams.
- Silky soft tricot, ¾-length knee brace, optimized lining.
- Patterned and fit for every style of rider.

Please refer to the sizing chart below:

Size	Code	Size	Code	Size	Code	Size	Code
28	36	32	38	36	40	40	42
30	37	34	39	38	41	42	43

NEW Can-Am x FH Dust Jersey

288234 • S, M, L, XL, 2XL, 3XL

Army Green (77), Black (90)



High-performance jersey utilizing breathable materials with a traditional cut.

- 100% polyester.
- Fit: Regular.
- High-quality silk-screened graphics.
- Moisture-wicking materials help keep you dry.
- Mesh vent paneling on sides and under sleeves for airflow.
- Drop tail on back panel to keep jersey tucked in and secure.
- Athletic fit, moderately slim throughout body and sleeves.
- Overlocked stitching for superior durability and longevity.

NEW Can-Am x FH High Country T-Shirt

288235 • S, M, L, XL, 2XL, 3XL

Bronze (92)



Can-Am x Fasthouse Collab T-Shirt with large soft plastisol print at back and small print at front chest.

- 60% cotton, 40% polyester.
- Fit: Slim.
- Rib-knit crew neck.
- Woven label Can-Am x Fasthouse on wearer's right sleeve.

Can-Am x FH Mav T-Shirt

288218 • S, M, L, XL, 2XL, 3XL

Black (90), Sand (03)



Can-Am x Fasthouse collab T-shirt with large artistic vehicle print at back.

- 60% cotton, 40% polyester.
- Fit: Slim.
- Ribbed collar.
- Quote at left chest and large artwork at back.

Can-Am x FH Off-Road Crew T-Shirt

288224 • S, M, L, XL, 2XL, 3XL

Army Green (77), Black (90)



Can-Am x Fasthouse collab t-shirt with large Off-Road graphic at back.

- 60% cotton, 40% polyester.
- Fit: Slim.
- Ribbed collar.
- Quote at left chest and back.

Can-Am x FH Ride Out T-Shirt

288225 • S, M, L, XL, 2XL, 3XL

Black (90), White (01)



Can-Am x Fasthouse collab T-shirt with artistic landscape printed at back.

- 60% cotton, 40% polyester.
- Fit: Slim.
- Ribbed collar.
- Brand logo at center front and large artwork at back.

Can-Am x FH Adventure Long-Sleeve T-Shirt

288226 • S, M, L, XL, 2XL, 3XL

Black (90), White (01)



Can-Am x Fasthouse collab long-sleeve T-shirt with brand logos and emblematic Can-Am lines.

- 60% cotton, 40% polyester.
- Fit: Slim.
- Ribbed collar.
- Brand logos at center front and back.

MEN'S

Can-Am x FH Coilover Tee**288065** • S, M, L, XL, 2XL, 3XL

Black (90)



- Ultrasoft 100% combed ring-spun cotton tee.
- 100% combed ring-spun cotton.
 - Fit: Slim.
 - Soft and lightweight material.
 - Crew collar.
 - Plastisol ink screen-printed graphics.

WOMEN'S

NEW Can-Am x FH Off-Road Crew Pullover Hoodie**288229** • S, M, L, XL, 2XL

Ivory (97)



- Midweight hooded pullover for women.
- 80% cotton, 20% polyester.
 - Fit: Regular.
 - Soft midweight material (280 gsm).
 - Two front welt pockets.
 - Metal eyelets and hood drawstring.
 - Screen printed graphics.
 - Ribbed sleeve cuffs and waistband hem.

Can-Am x FH Adventure T-Shirt**288228** • XS, S, M, L, XL, 2XL

Black (90), Sand (03)



- Can-Am x Fasthouse collab women's T-shirt with brand logos and emblematic Can-Am lines.
- 60% cotton, 40% polyester.
 - Fit: Slim.
 - Ribbed collar.
 - Brand logos at center front and back.

NEW Can-Am x FH Adventure Beanie**288231** • One size

Army Green (77), Black (90)



- Can-Am x Fasthouse collab heavy-knit cuff beanie.
- 100% acrylic.
 - Ultrasoft anti-itch material.
 - Can-Am x Fasthouse woven patch at front.
 - Small folded Can-Am x Fasthouse label at back.

UNISEX

NEW Can-Am x FH Straw Hat**448814** • One size

Khaki (05)



- Wide-brim straw hat with adjustable chin strap.
- 100% straw.
 - Patch at front.
 - One size fits most.

NEW Can-Am x FH Tube**288232** • One size

Black (90), Wine (32)



- Multipurpose, stretch and comfortable tubular headwear.
- 92% polyester, 8% spandex.
 - 12 different configurations: bandana, headband, balaclava and more.

Can-Am x FH Dust Mesh Cap**288238** • One size

Black (90), Whiskey (28)



Check out the Can-Am x FH Dust cap, a medium-profile structured 5-panel snapback constructed using a premium cotton/poly blend. Features a front patch and custom trims throughout.

- 60% cotton, 40% polyester.
- 5-panel construction.
- Deep profile, structured.
- Woven front patch.
- Contrast snapback closure.

Can-Am x FH Road Cap**288230** • One size

Black (90)



Can-Am x Fasthouse collab structured 5-panel trucker-style cap with snapback closure.

- 100% cotton.
- 5-panel construction.
- Curved brim.
- Woven patch at front.
- Branded taping and flag label.
- Snapback closure at back.

Can-Am x FH Racing Flat Brim Cap**448804** • One size

Black (90), Brown (04)



Structured 5-panel snapback with flat brim using premium acrylic wool.

- 100% cotton.
- 5-panel construction.
- Flat brim and matching underbrim.
- Branded taping and flag label.
- Contrast snapback.
- Snapback closure at back.

Can-Am x FH Badge Cap**448805** • One size

Army Green (77), Ivory (97)



Structured 5-panel trucker-style cap with snapback closure.

- 100% cotton.
- 5-panel construction.
- Curved brim.
- Woven patch at front.
- Branded taping and flag label.
- Snapback closure at back.

CAN-AM OFF-ROAD x 24.7

**Hunt limited-edition hat capsule.
Built for the hunt, backed by the ride.**

Where grit meets gear: Can-Am Off-Road and 24.7 Hunt unveil an exclusive hat collection designed for those who live the outdoors without compromise. As a top Can-Am Off-Road Ambassador since 2024, 24.7 Hunt has earned a reputation as one of the most respected names in the hunting and conservation community, bringing proven insight, a relentless pursuit of the passion, and a deep respect for the land and its animals into everything they do.

This collaboration isn't just about style—it's about being unstoppable. These hats are made for the early risers and late nighters who do it all in their own pursuits.



Unisex Can-Am
x 24.7 Curved Cap
288482_90



Unisex Can-Am
x 24.7 Red/Black
Flat Cap
288483_30



Unisex Can-Am
x 24.7 Green
Rope Cap
288484_77



Unisex Can-Am
x 24.7 Black
Mesh Flat Cap
288485_90



24.7 x CAN-AM COLLECTION

UNISEX

Can-Am x 24.7 Curved Cap

288482 • One size

Black (90)



- Can-Am x 24.7 Hunt Collaboration.
- Content: 100% cotton corduroy.
 - 5-panel construction.
 - Curved brim.
 - Embroidered woven patch at front.
 - Embroidered brands on both sides of the cap.
 - Branded an-Am taping inside.
 - Snapback closure at back.

Can-Am x 24.7 Red/Black Flat cap

288483 • One size

Red (30)



- Can-Am x 24.7 Hunt Collaboration.
- Content: 100% cotton corduroy.
 - 5-panel construction.
 - Flat brim.
 - Half structured front.
 - Rope.
 - Embroidered woven patch at front.
 - Embroidered brands on both sides of the cap.
 - Branded Can-Am taping inside.
 - Snapback closure at back.

Can-Am x 24.7 Green Rope Cap

288484 • One size

Army Green (77)



- Can-Am x 24.7 Hunt Collaboration.
- Content: 100% cotton.
 - 5-panel construction.
 - Flat brim.
 - Rope.
 - Embroidered Duck patch in Can-Am color at front.
 - Embroidered brands on both sides of the cap.
 - Branded an-Am taping inside.
 - Snapback closure at back.

Can-Am x 24.7 Black Mesh Flat Cap

288485 • One size

Black (90)



- Can-Am x 24.7 Hunt Collaboration.
- Content: 100% cotton.
 - 5-panel construction.
 - Flat brim.
 - Structured front.
 - Mesh back.
 - Embroidered woven patch at front.
 - Embroidered brands on both sides of the cap.
 - Snapback closure at back.

EVERYDAY WEAR AND SIGNATURE

Our redesigned everyday and Signature collections.

Perfect for those who crave adventure and want to get the job done. Featuring a fresh selection of stylish and practical pieces such as flannel shirts, caps, T-shirts and more!



Men's Can-Am
DNA T-Shirt
ARMY GREEN
288173_77



Unisex Can-Am
Loyal Flat Mesh Cap
BLACK
288143_90



Unisex Can-Am
Laser Cut Curved Cap
SAND
288144_03



Unisex Can-Am
Reversible Camo
Beanie
GREY
288160_09



Men's Can-Am
Emblem Pullover
Hoodie
BLACK
288244_90



Men's Can-Am
Plaid Flannel Shirt
SAND
288165_03

EVERYDAY WEAR

MEN'S

NEW Can-Am All-Star T-Shirt

288181 • S, M, L, XL, 2XL, 3XL

Army Green (77), Black (90),
Wine (32)



- Casual T-shirt for everyday wear.
- 60% cotton, 40% polyester.
 - Fit: Slim.
 - Rib-knit crew neck.

NEW Can-Am All Terrain T-Shirt

288184 • S, M, L, XL, 2XL, 3XL

Black (90), Heather Grey (27)



- Men's Casual Graphic T-Shirt with Can-Am Crest artwork.
- Solid: 60% cotton, 40% polyester.
 - Heather: 97% cotton, 3% polyester.
 - Fit: Regular.
 - Rib-knit crew neck.
 - Small artwork at left chest and artwork at back.

NEW Can-Am Heritage T-Shirt

288275 • S, M, L, XL, 2XL, 3XL

Black (90), Heather Grey (27)



- Men's Casual Graphic T-Shirt with Heritage artwork at back.
- Solid: 60% cotton, 40% polyester.
 - Heather: 97% cotton, 3% polyester.
 - Fit: Regular.
 - Ribbed collar.
 - Small Can-Am logo at left chest and artwork at back.
 - Small embroidered label at front.

NEW Can-Am '73 T-Shirt

288276 • S, M, L, XL, 2XL, 3XL

Black (90)



- Men's Casual Graphic T-Shirt with large '73 Can-Am logo at front.
- 60% cotton, 40% polyester.
 - Fit: Regular.
 - Ribbed collar.
 - Small embroidered label at front.

NEW Can-Am Legacy T-Shirt

288279 • S, M, L, XL, 2XL, 3XL

Heather Charcoal (29), White (01)



- Men's Casual Graphic T-Shirt with retro Can-Am logo at front.
- 60% cotton, 40% polyester.
 - Fit: Regular.
 - Ribbed collar.
 - Small embroidered label at front.

Can-Am Plaid Flannel Shirt**288165** • S, M, L, XL, 2XL, 3XL

Sand (03)



Comfortable plaid flannel shirt, perfect for all your adventures!

- 100% cotton.
- Fit: Regular.
- Front opening with debossed Can-Am 4-hole buttons.

- Left chest pocket with small Can-Am embroidery.
- Contrast woven back yoke, chest pocket and elbow patches for more durability.

Can-Am Bonded Plaid Overshirt**288163** • S, M, L, XL, 2XL, 3XL

Army Green (77)



Bonded micro-fleece plaid overshirt, perfect for colder days.

- 100% cotton, fleece, 100% polyester.
- Fit: Relaxed.
- Front opening with debossed Can-Am 4-hole buttons.
- Herringbone weave bonded to soft micro polar fleece.
- Back yoke and chest pocket fabric cut on bias for stretch.

- Two hand pockets and two chest pockets.
- Small Can-Am embroidered logo at front left pocket.
- Self hanger loop centered at back yoke.

Cobra Desert Pullover Hoodie**288155** • S, M, L, XL, 2XL, 3XL

Black (90), Heather Grey (27)



Casual pullover hoodie with desert-inspired artwork at back.

- 60% cotton, 40% polyester.
- Fit: Regular.

- Rib at cuffs and hem.
- Kangaroo pocket.
- Soft plastisol print graphic at back. Regular Can-Am logo at left chest.

Cobra Desert T-Shirt**288151** • S, M, L, XL, 2XL, 3XL

Black (90), Sand (03)



Men's casual graphic T-shirt with desert-inspired artwork at back.

- 60% cotton, 40% polyester.
- Fit: Regular.

- Ribbed collar.
- Small Can-Am logo at left chest and artwork at back.

Can-Am Loyal T-Shirt**288152** • S, M, L, XL, 2XL, 3XL

Black (90), Heather Grey (27)



Men's casual graphic T-shirt with Can-Am printed quote at back.

- 60% cotton, 40% polyester.
- Heather Grey (27): 97% cotton, 3% polyester.
- Fit: Regular.

- Ribbed collar.
- Small Can-Am logo at left chest and artwork at back.

Can-Am Fearless Ally T-Shirt

288153 • S, M, L, XL, 2XL, 3XL

Army Green (77), Black (90)



Men's casual graphic T-shirt with large cobra artwork at front.

- 60% cotton, 40% polyester.
- Fit: Regular.

- Ribbed collar.
- Large cobra artwork at front with Can-Am mention.

Can-Am DNA T-Shirt

288173 • S, M, L, XL, 2XL, 3XL

Army Green (77), Black (90)



Men's Can-Am graphic T-shirt, perfect for everyday wear.

- 60% cotton, 40% polyester.
- Fit: Regular.

- Ribbed collar.
- Large Can-Am graphic at front.

Can-Am Bones T-Shirt

288182 • S, M, L, XL, 2XL, 3XL

Black (90), Heather Grey (27)



Men's casual graphic T-shirt with skeletal vehicle artwork printed at back.

- 60% cotton, 40% polyester.
- Heather Grey (27): 97% cotton, 3% polyester.
- Fit: Regular.

- Ribbed collar.
- Small Can-Am logo at left chest and large artwork at back.

Can-Am Badges Long Sleeve T-Shirt

288166 • S, M, L, XL, 2XL, 3XL

Black (90)



Men's long-sleeve T-shirt with printed Can-Am badges.

- 60% cotton, 40% polyester.
- Fit: Regular.

- Ribbed collar.
- Printed Can-Am badges on the sleeve and left chest.

NEW Can-Am All-Star T-Shirt

288149 • XS, S, M, L, XL, 2XL

Black (90), Wine (32)



Women's Casual Graphic T-Shirt.

- Solid color: 60% cotton, 40% polyester.
- Heather color: 97% cotton, 3% polyester.
- Fit: Slim.
- Rib-knit crew neck.

NEW Can-Am Heritage T-Shirt

288285 • XS, S, M, L, XL, 2XL

Black (90), Pink (36)



Women's Casual Graphic T-Shirt with Heritage artwork at back.

- Content: 60% cotton, 40% polyester.
- Fit: Slim.
- Ribbed collar.
- Small Can-Am logo at left chest and artwork at back.
- Small embroidered label at front.

NEW Can-Am '73 T-Shirt

288286 • XS, S, M, L, XL, 2XL

Black (90)



- Women's Casual Graphic T-Shirt with large 73 Can-Am logo at front.
- Content: 60% cotton, 40% polyester.
 - Fit: Slim.
 - Ribbed collar.
 - Small embroidered label at front.

Can-Am Loyal T-Shirt

288150 • XS, S, M, L, XL, 2XL

Black (90), White (01)



- Women's casual graphic T-shirt with Can-Am printed quote at back.
- 60% cotton, 40% polyester.
 - Fit: Slim.
 - Ribbed collar.
 - Small Can-Am logo at left chest and artwork at back.

NEW Can-Am Mav Bones Flat Cap

288176 • One size

Army Green (77)



- Unisex Mav Bones Cap with flat brim.
- 100% cotton.
 - Structured 6-panel cap.
 - Snapback closure at back.
 - Inside Can-Am branded tape.
 - Patch at front.

NEW Can-Am King Cobra Curved Cap

288177 • One size

Black (90), Sand (03)



- Unisex King Cobra curved-brim cap.
- 100% cotton.
 - 6-panel cap.
 - Soft plastisol printed patch.
 - Can-Am branded tape inside and flag label at back.
 - Snapback closure at back.

NEW Can-Am Heritage Curved Cap

288264 • One size

Black (90)



- Classic Curved Cap with a Can-Am patch at front.
- 100% cotton.
 - 6-panel cap.
 - Heritage patch embroidered at front.
 - Can-Am branded tape inside.
 - Snapback closure at back.

Can-Am Laser Cut Curved Cap

288144 • One size

Black (90), Sand (03)



- Unisex breathable cap with laser-cut mesh.
- 100% polyester.
 - UPF 30 sun protection.
 - Quick-dry.
 - Silicon patch at front.
 - Snapback closure at back.

UNISEX

Can-Am Loyal Flat Mesh Cap**288143** • One size

Army Green (77), Black (90)



Unisex mesh cap with flat brim.

- Content: 100% cotton.
- Mesh: 100% polyester.
- Structured 5-panel cap.
- Snapback closure at back.
- Patch at center front.
- Small Can-Am label at back.

SIGNATURE COLLECTION

MEN'S

NEW 1973 Signature T-Shirt**288278** • S, M, L, XL, 2XL, 3XL

Black (90), Red (30), White (01)



Men's Casual Signature T-Shirt with Can-Am logo and 1973.

- 60% cotton, 40% polyester.
- Fit: Regular.
- Rib at cuffs and hem.
- Can-Am logo at center front and small 1973 printed on the right sleeve.
- Small embroidered label at front

1973 Signature LS T-Shirt**288355** • S, M, L, XL, 2XL, 3XL

Black (90)



Men's Casual Signature Long-Sleeve T-Shirt with Can-Am logo and 1973.

- 60% cotton, 40% polyester.
- Fit: Regular.
- Rib at cuffs and hem.
- Can-Am logo at center front and small 1973 printed on the right sleeve.
- Small embroidered label at front.

Can-Am Emblem T-Shirt**288148** • S, M, L, XL, 2XL, 3XL

Black (90), Heather Grey (27), Sand (03)



Men's Signature T-shirt with Can-Am logo and emblematic lines at front.

- 60% cotton, 40% polyester.
- Heather Grey (27): 97% cotton, 3% polyester.
- Fit: Regular.
- Ribbed collar.

NEW 1973 Signature Crewneck Sweatshirt**288353** • S, M, L, XL, 2XL, 3XL

Black (90)



Men's Signature Crewneck Sweatshirt with Can-Am logo and 1973.

- 60% cotton, 40% polyester.
- Fit: Regular.
- Rib at cuffs and hem.
- Can-Am logo at center front and small 1973 printed at back neck.
- Small embroidered label at front.

Can-Am Emblem Crewneck**288241** • S, M, L, XL, 2XL, 3XL

Black (90), Heather Grey (27)



Men's Signature crewneck sweatshirt with Can-Am logo and emblematic lines at front.

- 60% cotton, 40% polyester.
- Fit: Regular.
- Rib at cuffs and hem.

NEW 1973 Signature Pullover Hoodie**288354** • S, M, L, XL, 2XL, 3XL

Black (90), Heather Grey (27)



Men's Signature Pullover Hoodie with Can-Am logo and 1973.

- 60% cotton, 40% polyester.
- Fit: Regular.
- Rib at cuffs and hem.
- Kangaroo pocket.
- Can-Am logo at center front and 1973 printed across the center panel of the hood.
- Small embroidered label on the kangaroo pocket.

Can-Am Emblem Pullover Hoodie**288242** • S, M, L, XL, 2XL, 3XL

Black (90), Sand (03)



Men's Signature pullover hoodie with Can-Am logo and emblematic lines at front.

- 60% cotton, 40% polyester.
- Fit: Regular.
- Rib at cuffs and hem.
- Kangaroo pocket.

Can-Am Emblem Cap**288142** • One size

Army Green (77), Black (90), Burgundy (35), Heather Grey (27)



Signature cap with Can-Am logo and emblematic lines at front.

- 100% cotton.
- 6-panel cap.
- Embroidered Can-Am logo on the front.

- Can-Am branded tape inside and flag label at back.
- Snapback closure at back.

NEW 1973 Signature T-Shirt**288284** • XS, S, M, L, XL, 2XL

Black (90), Pink (36)



Women's Casual Signature T-Shirt with Can-Am logo and 1973.

- Content: 60% cotton, 40% polyester.
- Fit: Slim.
- Rib at cuffs and hem.
- Can-Am logo at center front and small 1973 printed on the right sleeve.
- Small embroidered label at front.

Can-Am Emblem T-Shirt**288187** • XS, S, M, L, XL, 2XL

Black (90), Sand (03)



Women's Signature T-shirt with Can-Am logo and emblematic lines at front.

- 60% cotton, 40% polyester.
- Fit: Slim.
- Ribbed collar.

NEW 1973 Signature Crewneck Sweatshirt**288352** • XS, S, M, L, XL

Black (90)



Women's Signature Crewneck Sweatshirt with Can-Am logo and 1973.

- Content: 60% cotton, 40% polyester.
- Fit: Slim.
- Rib at cuffs and hem.
- Can-Am logo at center front and small 1973 printed at back neck.
- Small embroidered label at front.

Can-Am Emblem Crewneck**288243** • XS, S, M, L, XL, 2XL

Black (90), Wine (32)



Women's Signature crewneck sweatshirt with Can-Am logo and emblematic lines at front.

- 60% cotton, 40% polyester.
- Fit: Slim.
- Rib at cuffs and hem.

NEW 1973 Signature Pullover Hoodie**288351** • XS, S, M, L, XL

Black (90), Wine (32)



Comfortable Pullover Hoodie sweatshirt with Can-Am logo on the front.

- Content: 60% cotton, 40% polyester.
- Fit: Slim.
- Rib at cuffs and hem.
- Kangaroo pocket.
- Can-Am logo at center front and 1973 printed across the center panel of the hood.
- Small embroidered label on the kangaroo pocket.

Can-Am Emblem Pullover Hoodie**288244** • XS, S, M, L, XL, 2XL

Army Green (77), Black (90)



Women's Signature pullover hoodie with Can-Am logo and emblematic lines at front.

- 60% cotton, 40% polyester.
- Fit: Slim.
- Rib at cuffs and hem.
- Kangaroo pocket.

NEW Can-Am 1973 Signature Cap**288112** • One size

Army Green (77), Black (90), Grey (09), Red (30), Wine (32)



Signature curved cap.

- 100% cotton.
- 6-panel cap.
- Embroidery Can-Am patch at front.
- Snapback closure at back with small Can-Am label.

Can-Am Reversible Camo Beanie**288160** • One size

Army Green (77), Black (90), Grey (09)



Two-in-one reversible beanie with our new hexagon camo knit pattern.

- 95% acrylic, 4% nylon, 1% spandex.
- Hypoallergenic.
- Small folded Can-Am label at front.
- Embroidered Can-Am logo at front.

NEW 1973 Signature Bandana**288281** • One size

Black (90), Wine (32)



Our bandana is a cheerful accessory, perfect for our bold riders! It will become your new staple piece when riding.

- 100% cotton.
- Dimensions: 24" x 24".
- Can be worn many different ways.
- Checkered print, Can-Am logo and 1973 printed.

UV PROTECTION AND PLAY

Introducing our UV Protection and Play collection.

Your ultimate gear for all-day comfort, designed to protect against the sun. Featuring windproof jerseys, lightweight long-sleeve shirts, comfortable hoodies and more! All with new colors and graphics!



Men's UV Protection
Long-Sleeve T-Shirt
BLACK
288161_90

Women's
Can-Am
Lightweight
Tank Top
WINE
288167_32

Women's UV
Protection
Long-Sleeve T-Shirt
BLACK
288169_90

Men's UV Protection
Long-Sleeve Hoodie
ARMY GREEN
288168_77

UV PROTECTION AND PLAY

MEN'S

UV Protection Long-Sleeve T-Shirt

288161 • S, M, L, XL, 2XL

Black (90), Charcoal Grey (07)



Men's lightweight UV protection long-sleeve shirt, meant to protect your skin all day long.

- 92% polyester, 8% spandex.
- Fit: Regular.
- UPF 50 sun protection.

- Quick-dry fabric that helps distribute your body heat and rapidly cools through regulated evaporation.
- Can-Am artwork at back and Can-Am logo at right sleeve.

UV Protection Long-Sleeve Hoodie

288168 • S, M, L, XL, 2XL

Army Green (77), Black (90)



Men's UV protection long-sleeve hooded shirt with built-in gaiter to protect you from the dust and sun.

- 92% polyester, 8% spandex.
- Fit: Regular.
- 175 gsm.

- UV protection – 50 UPF.
- Quick-dry.
- Built-in gaiter mask.
- Can-Am logo on the right sleeve and artwork at left chest.

Can-Am DWR Hoodie

288158 • S, M, L, XL, 2XL, 3XL

Army Green (77),
Black with Graphics (94)



Versatile pullover hoodie with water-repellent finish that will allow you to wear it no matter the weather!

- 60% cotton, 40% polyester.
- Fit: Regular.
- Rib at cuffs and hem.

- Kangaroo pocket.
- New! Hexagon camo print.
- Can-Am label at front kangaroo pocket.

WOMEN'S

Can-Am Lightweight Tank Top

288167 • XS, S, M, L, XL, 2XL

Charcoal Grey (07), Wine (32)



Women's lightweight tank top, perfect for everyday wear.

- 88% nylon and 12% spandex.
- Fit: Regular.
- UPF 20 sun protection.

- Quick-dry fabric that helps distribute your body heat and rapidly cools through regulated evaporation.
- Large vertical Can-Am logo on the left side.

UV Protection Long-Sleeve T-Shirt

288169 • XS, S, M, L, XL, 2XL

Black (90)



Women's lightweight UV protection long-sleeve shirt, meant to protect your skin all day long.

- 92% polyester, 8% spandex.
- Fit: Slim.
- UPF 50 sun protection.

- Quick-dry fabric that helps distribute your body heat and rapidly cools through regulated evaporation.
- Thumbhole opening at sleeve.
- Can-Am artwork at back.

UNISEX

Can-Am Phantom Jersey

288270 • S, M, L, XL, 2XL, 3XL

Army Green (77), Burgundy (35),
Charcoal Grey (07), Grey (09)



Our classic Can-Am jersey with a new look!

- 100% polyester.
- Fit: Relaxed.
- Quick-dry, moisture-wicking fabric for maximum comfort.
- Antibacterial treatment for anti-odor.

- Mesh fabric for extra ventilation at underarms.
- Hexagon camo print.
- Sublimated logos.

PLAY AND LICENSING PRODUCTS

MISC

NEW 1:12 Maverick X RS Turbo RR Premium Replica

B10787 • One size

Black (90)



- Product dimensions: 286 x 155 x 145 mm
- Diecast metal and plastic.
- Free-rolling wheels.
- Articulated steering.
- Functional suspensions.
- Openable doors.
- Interior cab details.
- Authentic exterior design.

NEW 1:12 X3 X RS Turbo RR Premium Replica with accessories

B10788 • One size

Red (30)



- Product dimensions: 281 x 155 x 161 mm
- Diecast metal and plastic.
- Free-rolling wheels.
- Articulated steering.
- Functional suspensions.
- Openable doors.
- Interior cab details.
- Authentic exterior desing.

NEW 1:12 Maverick X RC Turbo RR Premium Replica

B10789 • One size

Red (30)



- Product dimensions: 286 x 155 x 145 mm
- Diecast metal and plastic.
- Free-rolling wheels.
- Articulated steering.
- Functional suspensions.
- Openable doors.
- Interior cab details.
- Authentic exterior desing.

NEW 1:32 Diecast Maverick Sport 24 pcs Case-Pack

B10790 • One size

Mixed color (18)



- This Case-Pack includes:
- 12 x 1:32 Maverick Sport X rc (Red)
 - 12 x 1:32 Maverick Sport X xc (Silver)

NEW 1:32 Diecast Maverick Trail 24 pcs Case-Pack

B10791 • One size

Mixed color (18)



- This Case-Pack includes:
- 12 x 1:32 Maverick Trail DPS (Black)
 - 12 x 1:32 Maverick Trail DPS (Blue)

NEW 1:32 Diecast Commander 24 pcs Case-Pack

B10792 • One size

Mixed color (18)



- This Case-Pack Includes:
- 12 x 1:32 Commander XT-P (Orange).
 - 12 x 1:32 Commander XT (Black).

MISC

NEW Diecast Traxter 24 pcs Case-Pack

B10793 • One size

Mixed color (18)



- This Case-Pack includes:
- 12 x 1:32 Traxter XMR (Silver)
 - 12 x 1:32 Traxter XT HD9 (Navy)

1:32 Diecast Maverick Bundle

B10777 • One size

Mixed color (18)



- Bundle includes:
- 10 x 1:32 Maverick X RS Turbo RR (Black).
 - 5 x 1:32 Maverick X RS Turbo RR (Blue).
 - 5 x 1:32 Maverick X RS Turbo RR (Red).
 - 2 x 1:32 Maverick X RS Turbo RR Sand (Red).
 - 2 x 1:32 Maverick X RS Turbo RR Winter (Red).

1:32 Diecast Outlander Bundle

B10778 • One size

Mixed color (18)



- Bundle includes:
- 12 x 1:32 Outlander XT 1000R (Blue).
 - 12 x 1:32 Outlander XT 1000R (Yellow).

1:32 Diecast Renegade Bundle

B10779 • One size

Mixed color (18)



- Bundle includes:
- 6 x 1:32 Renegade X xc (Sand).
 - 6 x 1:32 Renegade X xc (Red).
 - 6 x 1:32 Renegade X mr 1000R (Sand).
 - 6 x 1:32 Renegade X mr 1000R (Gold).

REPLACEMENT PARTS

MISC

Helmet Service Pad

448695 • One size

Black (90)

- Part made to support a helmet while servicing it.

VIBE

MISC

Vibe Microphone

929132 • One size

Black (90)



- Fits Vibe Communication System by BRP.

Vibe Speakers

929133 • One size

Black (90)





- Fits Vibe Communication System by BRP

PYRA

MISC









Pyra Headliner 	929060 • XS, S, M, L, XL, 2XL, 3XL	Charcoal Grey (07) • Fits Pyra helmet family.
Pyra Cheek Pads 	929061 • XS, S, M, L, XL, 2XL, 3XL	Charcoal Grey (07) • Fits Pyra helmet family.
Pyra Wind Deflector 	929062 • S (fits XS/S/M/L), L (fits XL/2XL/3XL)	Black (90) • Fits Pyra helmet family.
Pyra Peak Pivots 	929073 • One size	Black (90) • Fits Pyra helmet family. • Includes 2 pcs.
Pyra Fixed Peak Pivots 	929096 • One size	Black (90) • Fits Pyra helmet family. • Includes 2 pcs.
Pyra Front Vent Grid 	929097 • S (fits XS/S/M/L), L (fits XL/2XL/3XL)	Black (90) • Fits Pyra helmet family.
Can-Am Pyra Phantom Peak 	929163 • S (fits XS/S/M/L), L (fits XL/2XL/3XL)	Black (90), Grey (09) • Fits Pyra helmet style 929159.
Pyra Fade Peak 	929091 • S (fits XS/S/M/L), L (fits XL/2XL/3XL)	Beige (02), Grey (09), Turquoise (Aqua) (76), White (01) • Fits Pyra helmet family.









MISC

Can-Am Pyra Peak	929063 • S (fits XS/S/M/L), L (fits XL/2XL/3XL)	Blue (80), Charcoal Grey (07), Red (30)
	• Fits Pyra helmet family.	
Can-Am Pyra Dune Peak	929064 • S (fits XS/S/M/L), L (fits XL/2XL/3XL)	Charcoal Grey (07), Grey (09), Red (30), Sand (03)
	• Fits Pyra helmet family.	

EXOME

MISC

NEW Exome Headliner		929188 • XS, S, M, L, XL, 2XL, 3XL	Black (90)
	• Fits Can-Am Exome Modular Helmet (DOT/ECE) (929190) and Can-Am Exome Open Face helmet (DOT/ECE) (929185).		
Exome Open Face Headliner		929147 • XS, S, M, L, XL, 2XL, 3XL	Charcoal Grey (07)
	• Fits Exome Open-Face helmet family. • DOT certified version only. • Not available in Europe		
Exome Summer Headliner		929049 • XS, S, M, L, XL, 2XL, 3XL	Charcoal Grey (07)
	• Fits summer Exome helmet family.		
Exome Single Lens Shield		929044 • One size	Clear (00)
	• Fits Can-Am Exome Helmet (929040). • Replacement Pinlock-ready face shield for Exome helmets.		
Exome Summer Chin Curtain		929046 • One size	Black (90)
	• Fits Can-Am Exome Helmet (929040).		
Exome Peak Fasteners Kit		929047 • One size	Black (90)
	• Fits Exome helmet family.		

Exome Peak	929057 • One size	Black (90), Matte Black (93)
	• Fits Exome helmet family.	
Exome Summer Vents Kit	929065 • One size	Black (90)
	• Fits Exome helmet family.	
Exome Pinlock® Insert	929066 • One size	Clear (00)
	• Fits Exome helmet family.	
Exome Shield Mechanism	929067 • One size	Black (90)
	• Fits Exome helmet family.	
Exome Shield Sealing Gasket	929070 • One size	Black (90)
	• Fits Exome helmet family.	
Exome Summer Sun Shield	 929072 • One size	Smoke (57), Clear (00)
	• Fits Exome helmet family.	
Exome Summer Chin Lock Covers	929075 • One size	Black (90)
	• Fits Exome helmet family.	
Exome Summer Cheek Pads	929092 • XS, S, M, L, XL, 2XL, 3XL	Charcoal Grey (07)
	• Fits summer Exome helmet family.	

MISC

Exome Open Face Peak**929145** • One size

Black (90)

- Fits Exome Open-Face helmet family.

**Exome Open Face Cheek Pads****929148** • XS, S, M, L, XL, 2XL, 3XL

Black (90), Charcoal Grey (07)

- Fits summer Exome Open-Face helmet family.



MISC

RETRO OPEN FACE**NEW Retro Open Face RPM Peak****929192** • One size

Black (90)

- Fits Retro Open Face helmets.

**NEW Retro Open Face Cheek Pads****929193** • S, M, L, XL, 2XL

Black (90)

- Fits Retro Open Face helmet.



MISC

FLINT**Flint Goggles Tear-Offs****448759** • One size

Clear (00)

- Ready-to-use clear tear-off tabs.
- Pack of 10.



**Flint Goggles Nose Guard****448760** • One size

Black (90)

- Fits all Flint goggles:
 - Flint Dune.
 - Flint Fade.
 - Flint Phantom.



MISC

Flint Goggles Clear Single UV Lens	448764 • One size	Clear (00)
	<ul style="list-style-type: none"> • Fits all Flint goggles: <ul style="list-style-type: none"> - Flint Dune. - Flint Fade. - Flint Phantom. 	
Flint Goggles Chrome Single UV Lens	448765 • One size	Blue (80), Chrome (99), Red (30), Turquoise (Aqua) (76), Yellow (10)
	<ul style="list-style-type: none"> • Fits all Flint goggles: <ul style="list-style-type: none"> - Flint Dune. - Flint Fade. - Flint Phantom. 	
Flint Photochromatic RPM Single UV Lens	448784 • One size	Smoke (57)
	<ul style="list-style-type: none"> • Fits Flint goggle family. 	

TRENCH

MISC

Trench Goggles Nose Guard	448708 • One size	Black (90)
	<ul style="list-style-type: none"> • Fits Trench goggles. 	
Trench Goggles Single UV Lens	448697 • One size	Clear (00)
	<ul style="list-style-type: none"> • Trench anti-scratch, anti-fog RPM lens. • Clear. 	
Trench OTG Goggles Single UV Lens	448793 • One size	Clear (00), Smoke 60% (21)
	<ul style="list-style-type: none"> • Fits Trench OTG goggle family. • Can-Am laser etching on lens. 	
Trench Goggles Tear-Offs	448727 • One size	Clear (00)
	<ul style="list-style-type: none"> • Compatible with the Can-Am Trench goggle. • Pack of 10. 	
Trench OTG Goggles Tear-Offs	448795 • One size	Clear (00)
	<ul style="list-style-type: none"> • Fits Trench OTG goggle family. • Pack of 10. 	



BRP REIMAGINES THE WAY YOU ACCESS YOUR WORLD

Can-Am is one of many success stories from BRP, the global company behind some of the most daringly innovative products and experiences that move you. **Because it's not about the destination, it's about the journey — yours.**

Discover our brands:

ski-doo ***LYNX*** ***SEADOO*** ***Can-am*** ***ROTAX***

www.brp.com





CANAMOFFROAD.COM

